

An aerial photograph of a swimming pool with clear turquoise water. A man in blue shorts and sunglasses is floating on a large, colorful, striped inflatable ring. A woman in a pink bikini and a wide-brimmed white hat is floating on a large, colorful, confetti-patterned inflatable ring. The pool is bordered by a wooden deck at the top and a sandy area at the bottom. Palm fronds are visible in the corners. The text 'FLUIDRA' is printed in white on the water.

FLUIDRA

POOL & SPA
GENERAL CATALOGUE
2022

ASTRALPOOL 

 **CEPEX**

ctx
pro

PISCINE
L'AGHETTO

FLUIDRA

THE PERFECT POOL EXPERIENCE

Founded in 1969, Fluidra is a leader in the global pool & wellness industry with a long-standing experience in developing innovative products and services in the residential and commercial pool market. We offer our customers an expansive array of products across the most trusted brands with a strong geographical footprint in over 45 countries. Thanks to this multicultural background, Fluidra is able to fully understand the requirements of its customers and adapt to them.

We have over 6,000 employees and the necessary resources to accelerate innovation in critical areas like energy-efficiency, robotics and the Internet of Things.

One of the latest highlights is that we have developed our **2020-2026 ESG Plan "Responsibility Blueprint"** with the aim of integrating sustainability into business management. We are convinced that a company with high ESG standards is a more economically sustainable company and one that is more highly valued by its customers, employees and shareholders.

We have made small but significant changes to our Mission to reflect our new ESG initiative: **"To create the perfect pool and wellness experience responsibly"**. Furthermore, we're also taking the opportunity to introduce a new company Vision – bearing in mind that the Mission describes the "what"—that is, what we wake up to do every day, while the Vision describes the "why"—that is, why do we do it, our motivating reason or purpose.

MISSION

To create the perfect pool & wellness experience responsibly

VISION

To enhance lives through **innovative and sustainable solutions** that transform the way people enjoy **water** for recreation and health



CUSTOMER COLLABORATION

We add value for our users and customers



PASSION FOR SUCCESS

We are committed, accountable and consistent



HONESTY & TRUST

We are fair, transparent and accessible



TEAMWORK & INCLUSION

We are humble and consider all perspectives

OUR VALUES



EXCELLENCE & INNOVATION

We continuously improve and aim responsibly to be the best



LEARN & ADAPT

We are open minded, flexible and positive

www.fluidra.com



KEY FIGURES



Employees



Countries



Sales branches



Production centers

INTEGRATED BUSINESS MODEL



R+D+i

Excellence in innovation with +200 engineers and some 1,400 patents



Production

+35 flexible multi-technology plants in key countries



Logistics

Logistics operators to ensure fast and reliable deliveries



Distribution

+135 points of sale, giving support and training to the professional clients in over 45 countries



Engineering

Design and engineering of water projects

A GLOBAL POWERHOUSE

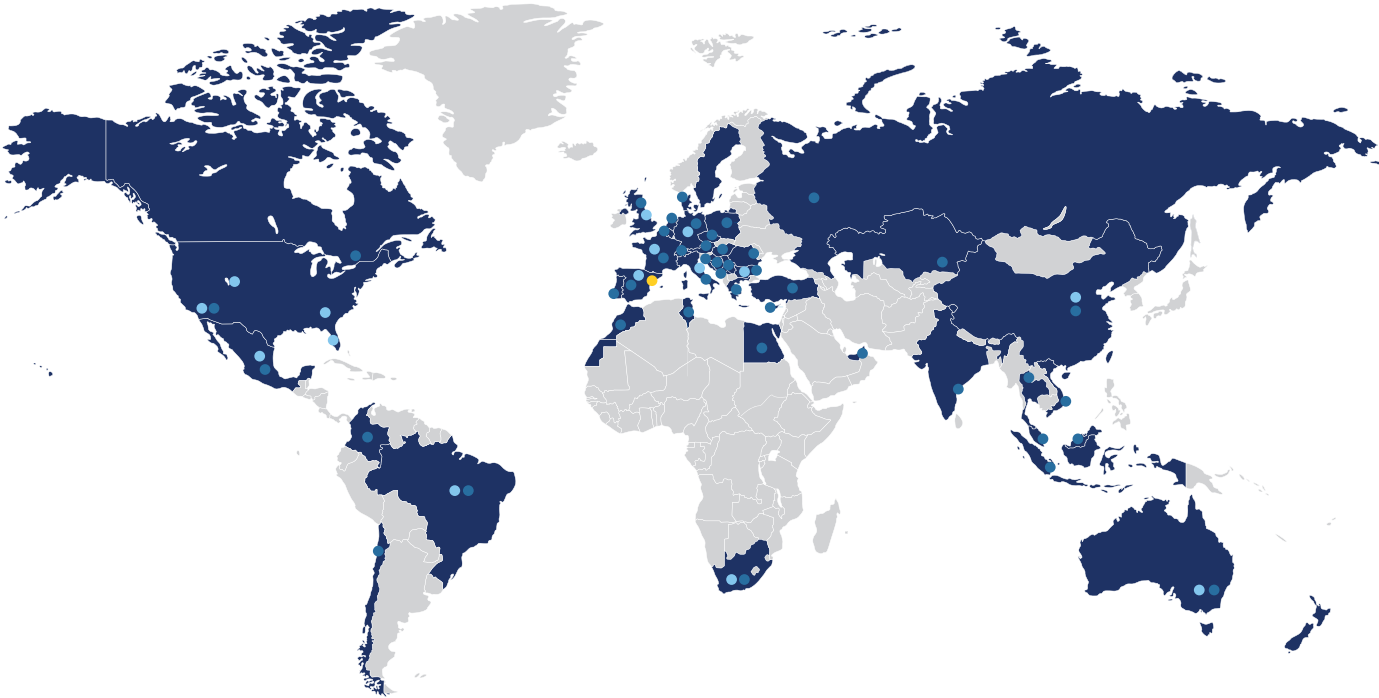

• Sales branches

• Production centres

• Headquarters

NEW PRODUCTS 2022



Chrome showers

+ Solar and non-solar chrome showers with elegant and stream-lined design.

See page 58



Skimmer Unik

+ The perfectly designed and evenly integrated skimmer.

See page 89



Galactic monoblock

+ The professional filtration set for in-ground and above ground pools.

See page 177



Senext XP

+ The small-sized single speed pump with big performance.

See page 205



Neolysis 2

+ The exclusive hybrid UV + salt water chlorination connected solution for the most demanding users.

See page 300



Fluidra Connect compatible



Lyriox UV-C

ASTRALPOOL

+ Affordable and easy-to-install UV system for an eco-friendly sanitation of most pools.

See page 302



High efficiency LumiPlus Flexi lamp

ASTRALPOOL

+ The most efficient solution 170 lm/W.
+ Compatible with all LumiPlus Flexi solutions.

See page 414



LumiPlus FlexiMini LED

ASTRALPOOL

+ The compact design LED with maximum customization for everyone's style.

See page 418



Octeo above-ground cover

ASTRALPOOL

+ A new designed model with 4 colours combination and an exclusive bluetooth receiver.

See page 497



Balance E spa

ASTRALPOOL

+ The balance between functionality, performance and cost.

See page 598



Guardian Pool commercial pools

ASTRALPOOL

+ A fully automated electronic water care control unit.

See page 906



Fluidra Connect compatible

NEW CTX 2022



ctx[®]
pro

ctx[®]
pro



CTX range

CTX, changes the image, to make the range clearer and more functional:

- + Maintenance range, 4 steps to follow to achieve the perfect pool water during the bathing season (Balance, Disinfection, Algicide, Flocculant).
- + Solution range, products designed to solve any possible problem that may arise in the pool.
- + Cleaning range to clean and care all elements of the pool.
- + Winter range to maintain the pool during winter.

CTX, the caring formula

See page 260

NEW PRODUCTS 2022



PISCINE
LAGHETTO[®]



Playa Twin

- + The new Playa Twin is enriched with a double sunbathing area that can become the cover of the mini-pool itself.

See page 542

PISCINE
LAGHETTO[®]

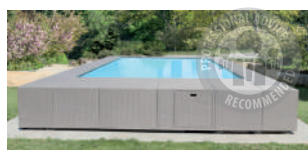

Divina Infinity

- + A new concept of overflow semi-inground pool, elegant and sophisticated.

See page 564

PISCINE
LAGHETTO[®]



Pop Crystal

- + With its strips of transparent liner and LED lights, POP Crystal offers a suggestive effect both during the day and the night.

See page 574

PISCINE
LAGHETTO[®]





HOW TO ENJOY

1 MAINTAIN WATER PARAMETERS

Step one:
MEASURE pH / Chlorine

2 times a week



Test strips



DPD1 Tablets



Blue Connect



Automatic equipment



Step two:
ADJUST



pH pH Minus or pH Plus

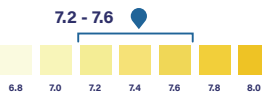

Free chlorine

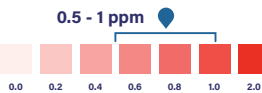

Chlorine tablets or liquid chlorine



Automatic dosing



Salt electrolysis

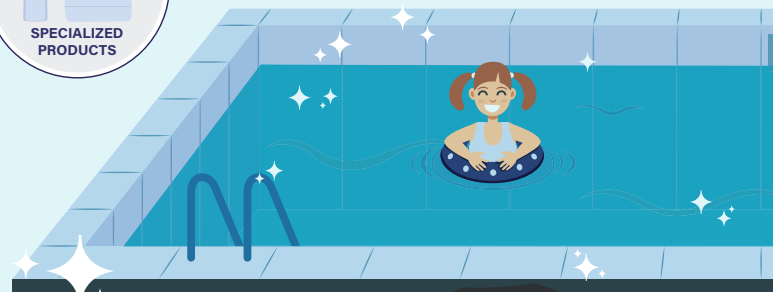
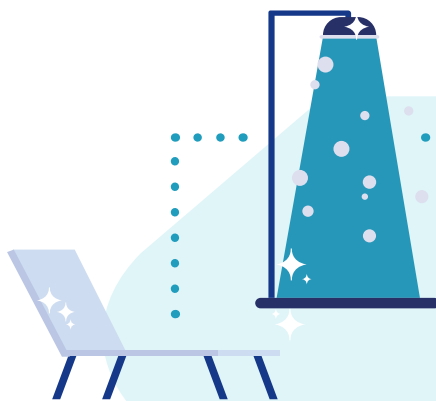

A properly treated swimming pool remain a safe place even with the new variants of the virus

A SAFE POOL

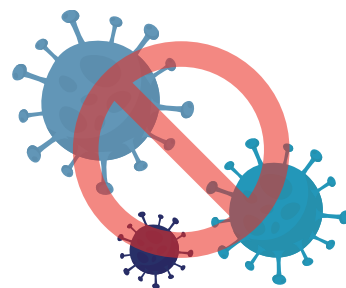

2 KEEP POOL AND EQUIPMENT CLEAN

3 DISINFECT THE POOL ENVIRONMENT

#EnjoyaSafePool



@Fluidra



Fluidra



Fluidra Group



POOL CLEANERS



BRUSH

Prefilter and skimmer cleaning



SKIMMER BASKETS



PRE-FILTER



FLUIDRA
THE PERFECT POOL EXPERIENCE

Live the perfect pool experience responsibly



Water conservation



Energy efficiency



Chemical reduction



Carbon reduction



Circular

FLUIDRA
THE PERFECT POOL EXPERIENCE

Our « eco-conscious » solutions



Fluidra is committed to develop more sustainable products and facilitate maintenance. We have selected a range of « eco-conscious » equipment to help you create a more sustainable pool experience.

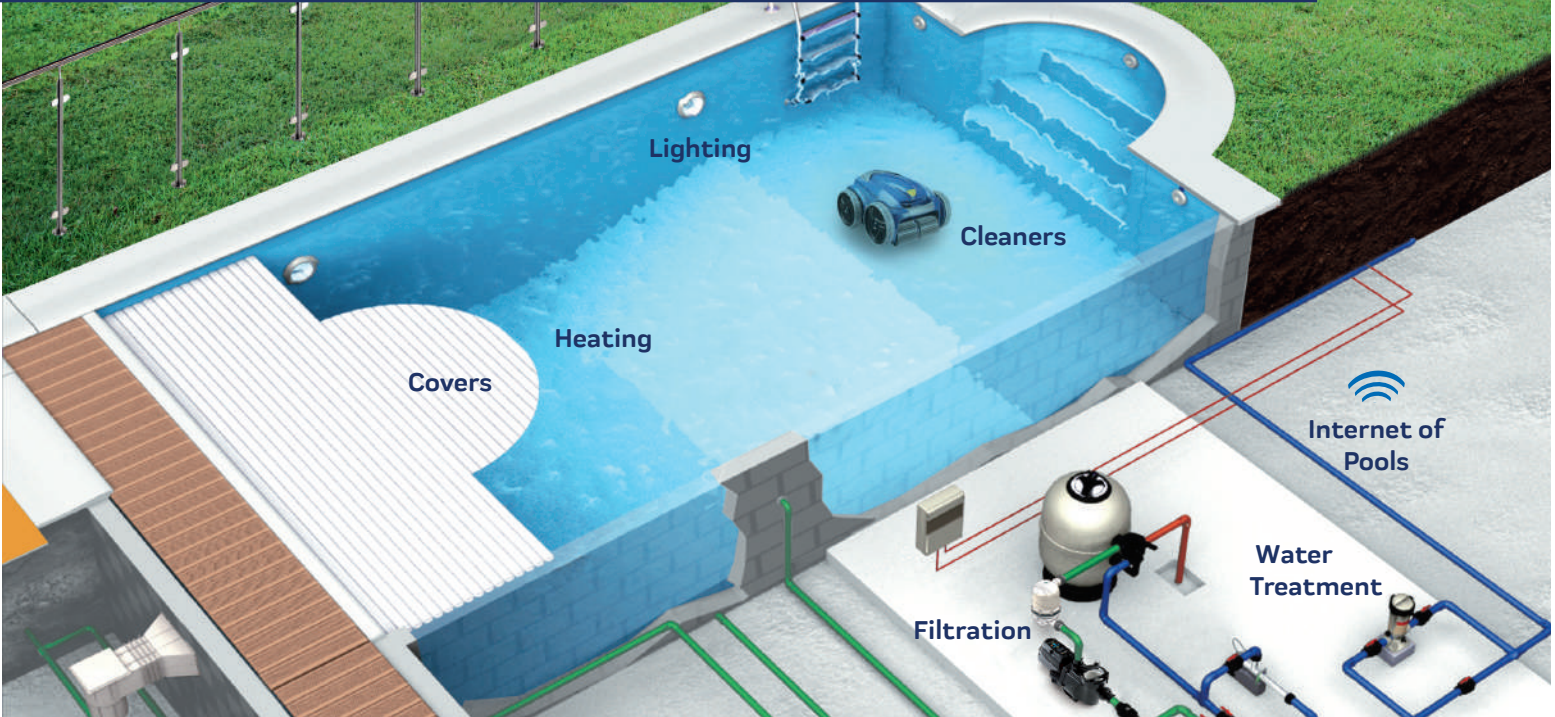

Filtration

The filtration system is at the heart of a pool. You can create a more sustainable pool through reduced energy consumption and water conservation. The technology of our **variable-speed pumps** saves up to 85%⁽¹⁾ of electric consumption. For optimal efficiency, combine it with the **AstralPool Classic Plus multiport valve** which reduces pressure drop by up to 20%⁽²⁾. Our range of **Zodiac® CS cartridge filters** doesn't require any backwash, reducing the consumption of water. If you prefer a traditional filter, our **AstralPool Active Clear Glass** from recycled glass as filter media saves up to 25%⁽³⁾ of water during the filter backwash.

Victoria Plus Silent VS
Filtration Pump

ASTRALPOOL 



Energy efficiency 

Classic Plus
Multiport valve

ASTRALPOOL 



Energy efficiency 

Active Clear Glass
Filtration media

ASTRALPOOL 





Water conservation 

⁽¹⁾ Comparison made vs an Astralpool and Zodiac® single speed pump. ⁽²⁾ Thanks to its sweep elbow. ⁽³⁾ Comparison made vs. sand media.

Heating and covers

The heat pump is the economical and ecological heating solution as it is a thermodynamic system: it takes calories from the air and transfers on average 5 times more energy directly to the water. Our **Inverter heat pumps** allow energy savings from 10% to 20% compared to an ON/OFF heat pump. By automatically adjusting their power based on the pool water temperature, they smartly optimize their energy consumption. A significant portion of our heat pumps sold in EMEA now use the R32 refrigerant gas, which has a 68% lower impact than the R410A refrigerant gas. Finally it is recommended to add a **thermal cover** to the heat pump. The cover helps reduce water evaporation up to 96% and heat losses up to 80%. As a result, the required heat pump power is divided by 2 on average.

Polycarbonate thermal Cover
ASTRALPOOL 

Energy efficiency 

Water conservation 

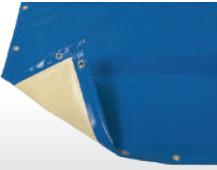



Bubble thermal cover
ASTRALPOOL 

Energy efficiency 

Water conservation 



Pro Elyo Touch Inverter heat pump
ASTRALPOOL 

Energy efficiency 





Water treatment

Thanks to our automatic water treatment solutions, the need to renew pool water can be significantly reduced. With **electrolysis and/or UV solutions**, the use of chemical products for water disinfection can be minimized. Finally, when using the **Magnapool® system**, with crystal clear glass media, water savings during filter backwashes can reach up to 75%⁽⁴⁾.

Neolysis 2
Salt water electrolysis + UV treatment
ASTRALPOOL 

No disinfection chemicals used
Less chlorine

Chemical reduction 



Elite Connect LS
Salt water electrolysis
ASTRALPOOL 

No disinfection chemicals used

Chemical reduction 



⁽⁴⁾ Comparison made with traditional salt water electrolysis using sand filtration media.

Lighting

With a very long lifetime - up to 20 times longer than halogen lighting and a top quality lighting, our LED technology reduces electrical consumption up to 97%⁽⁵⁾ vs halogens. Our range is made of high-quality LEDs and electronic components and manufactured entirely in the EU according to European quality standards.

LumiPlus Flexi
ASTRALPOOL 



Energy efficiency 

LumiPlus FlexiMini
ASTRALPOOL 



Energy efficiency 

⁽⁵⁾ With LumiPlus Flexi lamp. ⁽⁶⁾ scope 1 & 2



Low carbon

Fluidra maintains a strict policy and commitment to optimizing resources through the application of energy-efficiency measures and behaviors. Of the total energy consumed in 2020 in all companies of the Fluidra group, 35% came from indirect renewable energy sources. In particular, Fluidra's electricity supply in Spain and Portugal factories is 100% green energy from renewable sources with guaranteed supply, which contributes to reducing the company's carbon footprint. Fluidra has committed to be carbon neutral⁽⁶⁾ in all its operations by 2027.

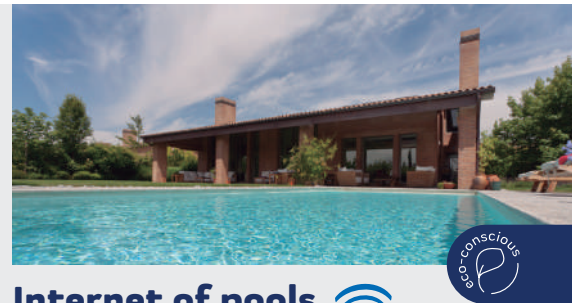

Internet of pools

All products can act together to make it a more efficient ecosystem.

Connected pool assistant

Blue Connect Plus provides all water parameters to users via the BlueRiiot app which also delivers in-app advices for an easier pool maintenance with only the right amount of chemicals used.

Blue Connect Plus
Smart pool water analyzer
blueriiot



Chemical reduction 

GENERAL INFORMATION

Unit conversion table

Length:	m	in	ft	
Metre (m)	1	39.370	3.281	
Inch (in)	0.025	1	0.083	
Foot (ft)	0.305	12	1	
Surface:	m ²	in ²	ft ²	cm ²
Square metre (m ²)	1	1,150.388	10.764	10,000
Square inch (in ²)	0.000645	1	0.0069	6.450
Square foot (ft ²)	0.093	144.036	1	929.03
Square centimetre (cm ²)	0.0001	0.155	0.00107	1
Volume:	m ³	UK gal	US gal	l
Cubic metre (m ³)	1	219.969	264.172	1000
Imperial gallon (UK gal)	0.0045	1	1.201	4.546
US gallon (US gal)	0.0038	0.833	1	3.785
Litre (l)	0.001	0.220	0.264	1
Speed:	m/s	in/s	ft/s	m/h
Metres / second (m / s) v	1	39.370	3.281	3600
Inch / second (in / s)	0.025	1	0.083	91.44
Foot / second (ft / s)	0.305	12	1	1097.28
Metre / hour (m / h)	0.00028	0.011	0.00091	1
Flow rate:	m ³ /m ² .h	US gal/ft ² .min	UK gal/ft ² .min	ft ³ /ft ² .min
(m ³ / m ² .h)	1	0.409	0.341	0.055
(US gal / ft ² .min)	2.445	1	0.833	0.134
(UK gal / ft ² .min)	2.936	1.201	1	0.158
(ft ³ / ft ² .min)	18.322	7.474	6.311	1
Mass:	kg	g	lb	
Kilogram (kg)	1	1000	2.205	
Gram (g)	0.001	1	0.0022	
Pound (lb)	0.454	453.59	1	
Pressure:	Pa	bar	kg/cm ²	psi
Pascal (Pa)	1	0.00001	0.00001	0.00014
Bar (bar)	100000	1	1.019	14.504
Kilogram / Square cent. (kg / cm ²)	98100	0.981	1	14.228
Pound / square inch (psi)	6894.76	0.0689	0.070	1
Energy:	J	kWh	cal	kcal
Joule (J)	1	0.000000277	0.239	0.00024
Kilowatt per hour (kWh)	3600000	1	860421	861.244
Calorie (cal)	4.186	0.00000116	1	0.001
Kilocalorie (kcal)	4186	0.0012	1000	1
Power:	kW	HP	BTU/h	
Kilowatt (kW)	1	1.341	3412.14	
Horsepower (HP)	0.746	1	2544.43	
British Thermal Unit / hour (BTU / h)	0.00029	0.00039	1	
Flow rate:	m ³ /h	US gal/min	UK gal/min	
Cubic metre / hour (m ³ / h)	1	3.667	4.403	
US gallon / minute (US gal / min)	0.273	1	1.201	
UK gallon / minute (UK gal / min)	0.227	0.833	1	
Litres / second (l / s)	3.6	13.198	15.85	
Temperature:	°C	°F	K	
Degrees Celsius (°C)	1	[(9/5)×°C]+32	°C+273.16	
Fahrenheit (F)	(5/9)×(°F-32)	1	n.a	
Kelvin (k)	K-273.16	n.a	1v	

Size of pipe and water flow rate

D mm	DN (Internal diam.) mm	Inches	Flow rate (m ³ /h) depending on the speed of the water	
			Suction (1.2 m/s)	Discharge (2 m/s)
20	15	½"	1	1.6
25	20	¾"	1.6	2.7
32	25	1"	2.7	4.4
40	32	1¼"	4.4	7.3
50	40	1½"	7.5	12.5
63	50	2"	11	18.4
75	65	2½"	15.7	26.1
90	80	3"	22.3	37.1

Due to ongoing changes, some photographs may not match the products exactly.

Printed on paper from sustainable forests. Fluidra contributes to environmental protection.





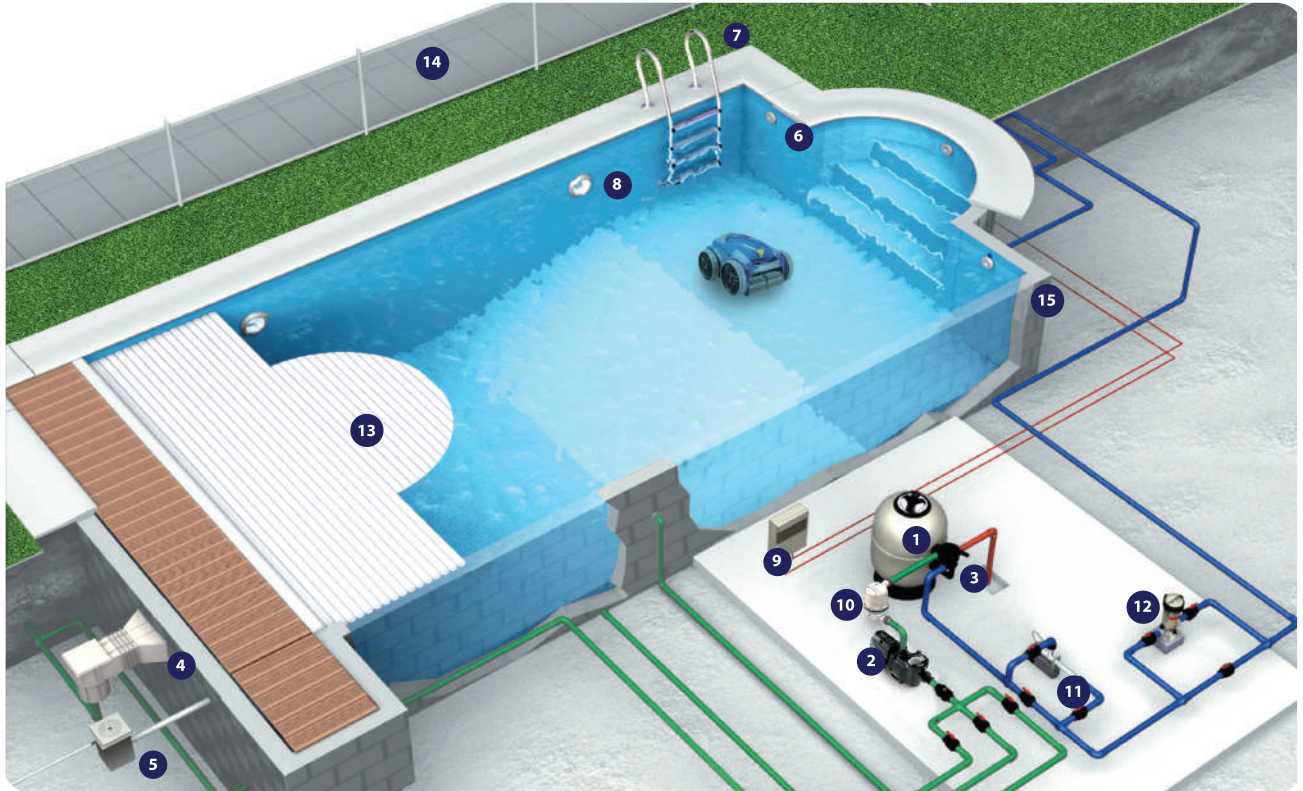



General diagram of installation of swimming pool equipment



- | | | | |
|-------------------|-------------------|----------------------------|-------------------------|
| 1 Filter | 5 Level regulator | 9 Electric control cabinet | 13 Automatic pool cover |
| 2 Pump | 6 Return inlet | 10 Hydrosprin | 14 Safety barriers |
| 3 Multiport valve | 7 Ladder | 11 Heat exchanger | 15 Pool shell |
| 4 Skimmer | 8 Light spot | 12 Chlorine dispenser | |

Filter and pump selection table

							
Pool volume	Daily filtration	Filtration speed	Filter Ø	Plumbing		Pump	Sand
m ³	h	m ³ /h/m ²	mm	mm	inches	HP	kg
30-40	8	50	500	50	1 1/2"	0.5	40
40-50	8	50	550	50	1 1/2"	0.75	60
50-60	8	50	600	50	1 1/2"	0.75	70
60-75	8	50	650	50	1 1/2"	1.0	100
75-90	8	50	750	50	1 1/2"	1.0	130
90-115	8	50	800	50	1 1/2"	1.5	160
115-130	8	50	850	63	2"	1.5	175
130-170	8	50	900	63	2"	2	300
170-200	8	50	900	63	2"	3	330

FLUIDRA PRO ACADEMY

THE **ONLINE**
LEARNING
PLATFORM FOR
FLUIDRA
CUSTOMERS

proacademy.fluidra.com

Fluidra Pro Academy is a learning platform designed for you, with all of the expertise and tools that you need to sell our products with confidence and assurance.

How to become a PRO?

- 1** Log on to proacademy.fluidra.com
- 2** Register
- 3** Start learning



Accessible
Anytime, anywhere



Quick and easy
Greater technical
expertise at your fingertips



Levels
Basic, Intermediate, Advance



Exclusive content
Learn what nobody else knows.
For professionals



The very latest
Be the first to find out about
new market launches



ASTRALPOOL 

ctx[®]
pro

PISCINE
LAGHETTO[®]

> PICTOGRAMS













your way around the catalogue

	2022 new products		Our "Eco-conscious" products
---	-------------------	---	------------------------------

ASTRALPOOL

















	3-year warranty		Best in class		Best value for money		Professional advice and/or installation recommended*
	Fluidra Connect compatible		PoolStation compatible		Recommended for public pools		Made in Europe
	Until end of stocks		Heat pump with full inverter technology		IE motor efficiency index		Complies with Standards EN 16582-1 and EN 16713-2
	Includes R410A gas		Includes R32 gas		Seawater-proof	* Product recommended for sale in physical stores due to the product's specialized and complex nature and/or its installation.	

ctx[®] pro

	Liquid		Gel		Buoy format		Monodosis
	Granulated		Powder		20 g Pill		30 g Pill
	100 g Tablet		250 g Tablet		Cartridge		All types of pools





INTERNET OF POOLS	19	
POOL SURROUND EQUIPMENT	37	
POOL SHELL EQUIPMENT	75	
FILTRATION	147	
PUMPS	183	
WATER TREATMENT PRODUCTS	209	
WATER TREATMENT EQUIPMENT	265	
CLEANING	293	
POOL LIGHTING	307	
POOL LINING MATERIAL	339	
COVERS AND ROLLERS	377	
PVC FITTINGS	417	
POOLS	429	
SPAS AND SAUNAS	481	
DEHUMIDIFICATION	525	
HEATING	529	
COMMERCIAL POOLS & WELLNESS	557	



INTERNET OF POOLS



blueriiot

20	SMART MAINTENANCE: BLUERIIOT CONNECTED POOL ASSISTANTS	31	Basic Plus
25	Blue Check	31	Net'N'Clean
25	Blue Connect GO	32	Complete White
25	Blue Connect Plus	32	Complete RGB
26	SMART POOL: ASTRALPOOL CONNECT & GO CONNECTED POWER CENTERS	33	Sub-assemblies
30	ASTRALPOOL CONNECT & GO PRODUCT RANGE	34	Expansion modules
30	Basic	35	Accessories

SMART
MAINTENANCEConnected
pool
assistants

blueriiot

Pool & Spa assistant

Enjoy again



Blueriiot Pool & Spa Assistant digitalises swimming pools and spas

Blueriiot Pool & Spa Assistant is an application that helps the user to maintain and enjoy his swimming pool or his spa, thanks to the integration of connected products and smart home services.

Blueriiot Pool & Spa Assistant gives the user the chance to enjoy his pool with peace of mind.

In one single App, the user benefits from several features :

- Access to pool data, water quality, and weather at the pool in real time.
- Easy configuration and maintenance of Blueriiot connected products.
- Tailor-made recommendations to obtain a crystal clear water. The right dosis of the right product, at the right time.
- Smart pool integration for infinite possibilities.

Blueriiot Pool & Spa Assistant compatibility & features

SMART MAINTENANCE
Connected pool assistants

BLUE CONNECT



NOTIFICATION WHEN AN ACTION IS REQUIRED



BLUE CHECK



ALL TYPES OF POOLS

Cl/Br/Salt



PROMOTE YOUR SHOP IN THE APP



WATER QUALITY



WEATHER DATA & FORECASTS



CHEMICAL ADVICES



ASTRALPOOL

VOICE ASSISTANT INTEGRATION



amazon alexa Google Assistant

Chemicals compatibility

The users can choose to use Blueriiot Pool & Spa Assistant with a specific product line. He will benefit from precise and adapted advices to this range of products.

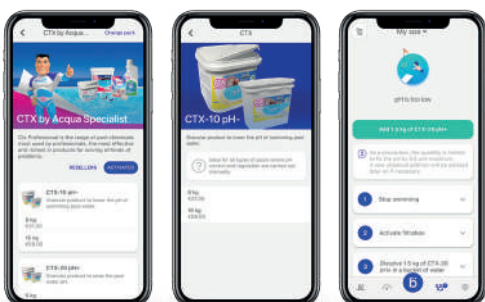

Voice assistant compatibility

Blueriiot Pool & Spa Assistant is compatible with the Amazon Alexa and Google Assistant voice assistants.



Blue Connect, the smart pool analyser

SMART MAINTENANCE

Connected
pool
assistants

Blue Connect is a smart device that analyses the quality of the water automatically. Combines with the free app Blueriiot Pool & Spa Assistant, it informs the user how to balance out the pool in easy, straight forward steps!

The device is equipped with an innovative sensor that measures the main parameters to keep a crystal clear water: pH, water temperature, ORP (disinfectant level) and conductivity.



ALWAYS CONNECTED

BLUE CONNECT IS ALWAYS CONNECTED THANKS TO DIFFERENT TECHNOLOGIES:



SIGFOX

BLUE CONNECT PROVIDES UP TO 20 AUTOMATIC REMOTE MEASUREMENTS PER DAY THANKS TO SIGFOX'S NETWORK DEDICATED TO CONNECTED DEVICES



BLUETOOTH

BLUE CONNECT USER CAN TAKE AN INSTANT MEASURE DIRECTLY WITH BLUETOOTH.



WI-FI

BLUE CONNECT WORKS WITH THE WI-FI NETWORK THANKS TO EXTENDER

PLUG & PLAY

BLUE CONNECT WORKS WITH ALL TYPES OF POOLS AND ITS INSTALLATION TAKES ONLY 3 MINUTES



1. DOWNLOAD THE APP
BLUERIIOT

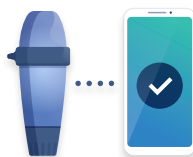

2. ACTIVATE BLUE CONNECT



3. INSTALL IN THE WATER OR IN THE
TECHNICAL ROOM (*FIT 50*)



4. ENJOY

Blue Check, the "smart" test strip

SMART MAINTENANCE

Connected pool assistants

Blue Check is a set of 50 test strips to use with the free application Blueriiot Pool & Spa Assistant that analyses the quality of the water by taking measurements manually. The app gives customised advices to maintain the pool. A simple solution to keep the water clean with peace of mind.



Blue Check measures:

- pH (6.2 - 8.4)
- Free chlorine (0 - 10)
- Bromine (0 - 20)
- Total alkalinity (0 - 240)
- Total hardness (0 - 1000)
- Cyanuric acid (0 - 300)

Blue Check is a complementary solution of Blue Connect, the smart pool analyser (see page 22). Thanks to Blue Check, you can ensure that the pool water is in balance by verifying other parameters such as the alkalinity, the hardness and the cyanuric acid. More info p. 250.

EASY TO USE

1

MAKE THE TEST AND ENTER THE STRIP'S VALUES IN THE APP
BLUERIIOT POOL & SPA ASSISTANT

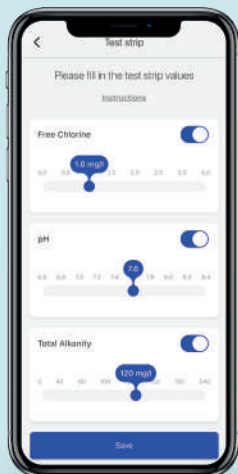

2

ACCESS THE POOL STATUS

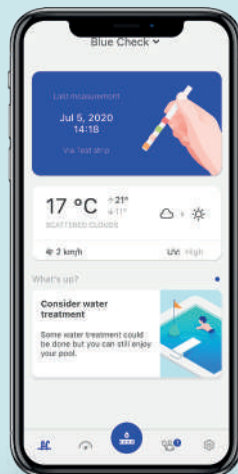

3

RECEIVE CUSTOM RECIPE ON WHICH CHEMICALS TO USE IN WHICH QUANTITY

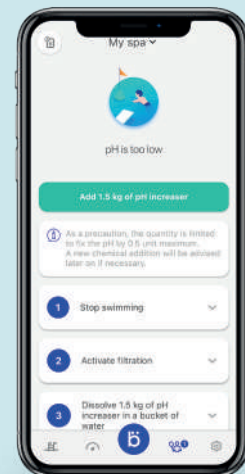

Virtual Pool Care platform

SMART MAINTENANCE

Connected
pool
assistants

Web platform dedicated to pool & spa professionals

www.virtualpoolcare.io is a web platform designed specifically for the pool and spa industry. It offers you the tools you need to organize your business, promote your products, services & shops towards Blueriiot users. Virtual Pool Care is available for computers, tablets or phones.

POOLS

MONITOR YOUR POOL & SPA PARK REMOTELY ON THE PLATFORM *VIIRTUAL POOL CARE*

- ALL YOUR CONNECTED POOLS AT FIRST GLANCE.
- FOLLOW LIVE THE ANALYSES OF YOUR CLIENTS' BLUE CONNECT.
- PERFORM ACCURATE AND PROFESSIONAL DIAGNOSIS.
- AVOID UNNECESSARY TRAVELS.
- ANTICIPATE AND ADVISE YOUR CLIENTS ON POSSIBLE PREVENTIVE ACTIONS.

EASY TO USE

1

CREATE A TOTALLY FREE ACCOUNT ON WWW.VIRTUALPOOLCARE.IO

2

SEND A SHARING REQUEST TO YOUR CUSTOMER USING THE KEY OF THE BLUE CONNECT TO ASK HIS PERMISSION TO SHARE THE BLUE CONNECT'S DATA

3

AS SOON AS HE ACCEPTS, YOU HAVE ACCESS TO HIS POOL'S DATA. YOU CAN MONITOR AS MANY AS POOLS OR SPAS AS YOU WANT.

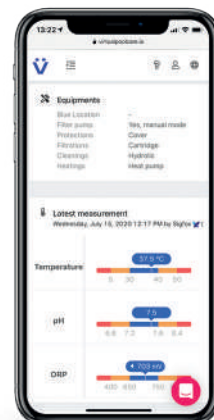

CHEMICAL PACK

BLUERIIOT POOL & SPA ASSISTANT PROMOTES FLUIDRA AND PARTNERS CHEMICAL BRANDS

- INCREASE CUSTOMERS LOYALTY TO THE PRODUCTS YOU SALE.
- INCREASE CUSTOMERS CONFIDENCE WITH TAILOR MADE CHEMICAL RECOMMENDATIONS.
- SUPPORT CUSTOMERS RETENTION.

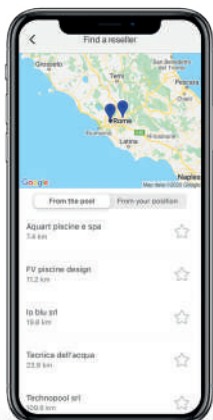
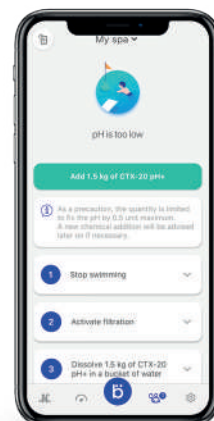

VENDOR LOCATOR

LIST YOUR SHOP(S)* IN THE APP *BLUERIIOT POOL & SPA ASSISTANT*

- PROMOTE YOUR SHOP VERY EASILY TO A VERY TARGETED AUDIENCE.
- GENERATE NEW LEADS GEOGRAPHICALLY.
- YOUR SHOP LISTED AS THE FAVORITE SHOP AND FIRST IN THE LIST.

* ASK YOU FLUIDRA'S SALES REPRESENTATIVE FOR MORE INFORMATION

Blueriiot water testers

SMART MAINTENANCE

Connected
pool
assistants

Blue Connect Range - Selection guide

Blue Connect is available in different packs with different functionalities to meet different needs.

Blue Check	Blue Connect GO	Blue Connect Plus
		

PRODUCT CHARACTERISTICS			
Water tester method	Test strips	Smart water analyzer (white color)	Smart water analyzer (blue color)
Analysis method	5-in-1 strips: free chlorine or bromine, pH, total alkalinity, cyanuric acid and total hardness	3-in-1 sensor: water temperature, pH, ORP/Redox	4-in-1 sensor: water temperature, pH, ORP/Redox, conductivity
Type of pool	Pools and spas	Pools and spas	Pools and spas
Disinfection method	Chlorine, Bromine, Salt	Chlorine, Bromine	Chlorine, Bromine, Salt
ACCESSORIES AND SERVICE			
Fit 50	-	Compatible	Included in the pack
Extender	-	Compatible	Compatible
Virtual Pool Care (Pools acces)	-	-	Included in the pack
CONNECTIVITY			
Bluetooth measurement via the app	-	✓	✓
Remote analysis with Wi-Fi network	-	Upon request (thanks to the Extender accessory)	Automatically (thanks to the Extender accessory)
Up to 20 measurements taken automatically and remotely with Sigfox	-	Subscription required	Included for life
BLUERIIOT POOL & SPA ASSISTANT APP			
Practical guide with chemical advice	✓	✓	✓
Chemical pack of your choice	✓	✓	✓
Value table	✓	✓	✓
Blueriiot Premium	-	Subscription required	Included for life

FLUIDRA CONNECT®

CONNECT & GO

**SMART
POOL**
Connected
hubs

The most comprehensive connected pool solution

1 Pre-wired power center cabinets
for easy installation

2 1 professional app
for easy configuration



3 1 user app to remotely
control the pool



4 Advanced management
with compatible products
(NN Things)

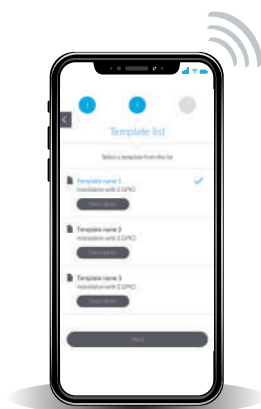

Fluidra Connect app for maximum convenience

- NN PRO for the professionals
- NN for the users



Fluidra Connect: Pool Professional benefits

NN PRO professional APP



www.fluidraconnect.com
web portal

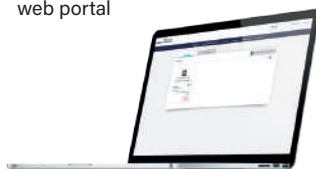

Fluidra Connect: Consumer benefits

NN consumer APP



Differentiation with Connected Pools.

- Better offer and service for the End User.



Fast & Easy installation.

- Drastically reduces the installation time thanks to pre-wired power center cabinets
- Easy on-site configuration using NN PRO app.



Savings.

- Cut back cost on better time and resource management.
- Can save unnecessary trips, petrol costs, toll fees, etc.



Remote maintenance.

- Piece of mind for Maintenance Professionals.
- Preventing and solving problems remotely using Fluidra Connect professional dashboards to see all pools at a glance.



Peace of mind.

- Dedicated user app for a pool always ready to use in the top conditions.
- Healthy water for you and your family.



Savings.

- A connected pool helps to save water, energy and use less chemical products.



Easy control.

- Access and control your pool 24/7 from anywhere, at any time, using the NN app.

FLUIDRA CONNECT®

CONNECT & GO



**SMART
POOL**
Connected
hubs

Maximum convenience & easy installation

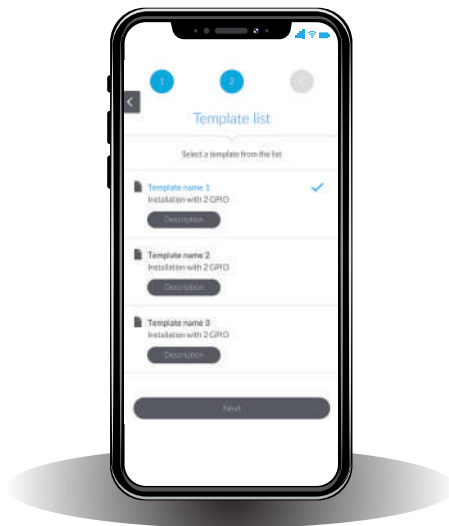

Once Connect & Go power center cabinet is installed and pool equipment wired to it, simply follow 4 easy steps:



- 1 Download the NN PRO app and create your professional user account. 
- 2 Scan Connect Box QR code to register the Connect & Go power center cabinet.
- 3 Scan power center cabinet barcode to get the predefined pool configuration template.
- 4 Launch NN compatible products auto detection using the app to get the pool dashboard. 

- Configuration is complete within a very short time
- Pool owner will also be able to access his pool using the NN consumer app



FLUIDRA CONNECT®

CONNECT & GO

**SMART
POOL**
Connected
hubs

Installation Diagram



**CONNECT & GO
POWER CENTER CABINET**

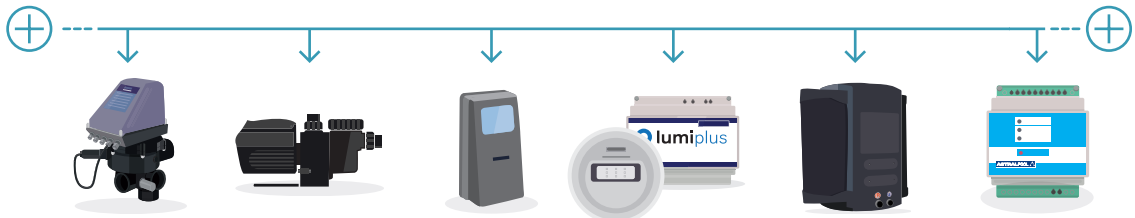

Smart control of "NN Thing" compatible products
(in addition to standard control: bilateral communication,
advanced status and messages, operational mode selection...)

GPIO*
Device with 4 inputs &
4 outputs provided
with Connect & Go
power center cabinet
to manage standard
products

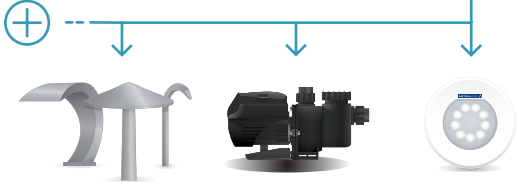

Standard control of any standard product
(on / off / scheduling / status)



Did you know?
Fluidra provides more than 100 products
able to offer a smart control and exchange
with Connect & Go pool automation.
Simply look for the "NN Thing" icon
in the product pages.

* 1 GPIO is installed inside Connect & Go power center cabinets. Additional GPIO can be purchased separately to control more equipment. See code 66671 on page 33.

FLUIDRA CONNECT®

CONNECT & GO

**SMART
POOL**
Connected
hubs

Range map

BASIC



BASIC PLUS



NET'N'CLEAN



COMPLETE WHITE



COMPLETE RGB



PRE-DEFINED TEMPLATES

CONNECT & GO VERSION	Fluidra code	1 pump (+ on/off button)	2 pumps (+ on/off buttons)	White light (+ on/off button)	LumiPlus RGB color light	Light Transformer included	Extra device (+ on/off button for standard chlorinator, booster pump, etc...)
BASIC	70874(C) / 70875(D)	✓		✓			
BASIC PLUS	70554(C) / 70555(D)	✓		✓			✓
NET'N'CLEAN	70556(C) / 70557(D)		✓				✓
COMPLETE WHITE	70697(C) / 70698(D)		✓	✓		✓	✓
COMPLETE RGB	70699(C) / 70700(D)		✓		✓	✓	✓

THE FUTURE
IS HERE

Convenience & easy installation

- + A range of Connect & Go power center cabinets is offered to suit most residential pools configurations.
- + Connect & Go power center cabinets contain all electrical protections and switches to manage pool equipment. Everything is pre-wired to ease installation process so it is the perfect solution for new pools, while also being adapted to retrofit situation (simply replace the whole filtration cabinet with Connect & Go).
- + Once installed, simply follow 4 easy steps:

1. Download the NN PRO app and create your professional user account.
2. Scan Connect Box QR code to register the Connect & Go power center cabinet.
3. Scan power center cabinet barcode to get the predefined pool configuration template.
4. Launch NN compatible products auto detection using the app to get the pool dashboard.

Type	Intensity range	Power Range 1-phase 230V
C	4A - 6.3A	¾ HP - 1 HP
D	6A - 10A	1.5 HP



Did you know ?

Fluidra provides more than 100 products able to offer a smart control and exchange with Connect & Go pool automation. Simply look for the "NN Thing" icon in the product pages.



Basic

DESCRIPTION

Control and power devices for a single-phase pump and control devices for lighting.

- IP-65 protection rating. Two transparent lids with lock and key.
- Products compatible with 220/240 V single-phase (P+N+T) 50 Hz/60Hz input.
- Internet connection required.
- Manual (selector) or automatic lighting control and pump.
- Includes Connect Box and 1 GPIO wiring.
- Enables optional temperature sensor connection (code 69682) with no need for accessories.
- Possibility of connecting a levels box.
- External transformer needed for lighting.
- Expansion modules can be connected for white, RGB and GPIO lighting.



Check out the expansion modules and accessories available for Connect & Go cabinets.

	Code	Standard Pack	Standard weight in kg	Standard volume in m ³
Basic C	70874	1	6.00	0.028
Basic D	70875	1	6.00	0.028

CONNECT & GO POWER CENTER CABINETS

Basic Plus



Check out the expansion modules and accessories available for Connect & Go cabinets.

DESCRIPTION

Control and power devices for a single-phase pump plus a control device for lighting.

- IP-65 protection rating. Two transparent lids with lock and key.
- Products compatible with 220/240 V single-phase (P+N+T) 50 Hz/60Hz input.
- Internet connection required.
- Manual (selector) or automatic control for lighting, pump and auxiliary devices.
- Includes Connect Box and 1 GPIO wiring.
- Enables optional temperature sensor connection (code 69682) with no need for accessories.
- Possibility of connecting a levels box.
- External transformer needed for lighting.
- Expansion modules can be connected for white, RGB and GPIO lighting.

	Code	Standard Pack	Standard weight in kg	Standard volume in m ³
Basic Plus C	70554	1	6.00	0.028
Basic Plus D	70555	1	6.00	0.028

Net'N'Clean



Check out the expansion modules and accessories available for Connect & Go cabinets.

DESCRIPTION

Control and power devices for a single-phase pump plus a control another device.

- IP-65 protection rating. Two transparent lids with lock and key.
- Products compatible with 220/240 V single-phase (P+N+T) 50 Hz/60Hz input.
- Internet connection required.
- Manual (selector) or automatic control for pump, an auxiliary pump and an auxiliary device.
- Includes Connect Box and 1 GPIO wiring.
- Enables optional temperature sensor connection (code 69682) with no need for accessories.
- Possibility of connecting a levels box.
- External transformer needed for lighting.
- Expansion modules can be connected for white, RGB and GPIO lighting.

	Code	Standard Pack	Standard weight in kg	Standard volume in m ³
Net'N'Clean C	70556	1	6.00	0.028
Net'N'Clean D	70557	1	6.00	0.028

CONNECT & GO POWER CENTER CABINETS

Complete White



FLUIDRA
CONNECT
INTERNET OF POOLS

Check out the expansion
modules and accessories
available for Connect &
Go cabinets.

DESCRIPTION

Control and power devices for two single-phase pump plus a control and power for white lighting.

- IP-65 protection rating. Three transparent lids with lock and key.
- Products compatible with 220/240 V single-phase (P+N+T) 50 Hz/60Hz input.
- Internet connection required.
- Manual (selector) or automatic control for pump, an auxiliary pump, an auxiliary device and lighting.
- Includes Connect Box and 1 GPIO wiring.
- Enables optional temperature sensor connection (code 69682) with no need for accessories.
- Possibility of connecting a levels box.
- A 100 VA transformer is included for lighting.
- Expansion modules can be connected for RGB and GPIO lighting.

	Code	Standard Pack	Standard weight in kg	Standard volume in m ³
Complete White C	70697	1	10.0	0.043
Complete White D	70698	1	10.0	0.043

Complete RGB



FLUIDRA
CONNECT
INTERNET OF POOLS

Check out the expansion
modules and accessories
available for Connect &
Go cabinets.

DESCRIPTION

Control and power devices for two single-phase pump plus a control and power for RGB lighting.

- IP-65 protection rating. Three transparent lids with lock and key.
- Products compatible with 220/240 V single-phase (P+N+T) 50 Hz/60Hz input.
- Internet connection required.
- Manual (selector) or automatic control for pump, an auxiliary pump and an auxiliary device.
- Includes Connect Box and 1 GPIO wiring.
- Enables optional temperature sensor connection (code 69682) with no need for accessories.
- Possibility of connecting a levels box.
- A 100 VA transformer is included for lighting.
- Expansion modules can be connected for white and GPIO lighting.

	Code	Standard Pack	Standard weight in kg	Standard volume in m ³
Complete RGB C	70699	1	10.0	0.043
Complete RGB D	70700	1	10.0	0.043



CONNECT & GO ACCESSORIES

- + While providing a convenient and easy to install solution with Connect & Go pre-wired power center cabinets, it is possible to create tailor-made Fluidra Connect automation for custom applications.
- + It can be either Fluidra Connect main components to create a custom installation or expansion modules to add features to a Connect & Go power center cabinet.

Custom installation

+ The following components are needed as a baseline (to be integrated in a specific power center cabinet - not provided):

- Connect Box which is the "brain" of Fluidra Connect automation.
- One or several GPIO control device(s) that will manage pool equipment.

Expansion modules (see next page)

+ 6 expansion modules are offered to bring additional features to Connect & Go power center cabinets:

- 3 modules to add 2 filter pumps control (available for 1, 2 & 3 HP pumps).
- 2 modules to add lighting management (available in white or RGB color with 100 VA transformer).
- 1 module to get an additional GPIO for pool equipment management.

THE FUTURE
IS HERE



Connect Box



DESCRIPTION

Connect Box is the brains behind a Fluidra Connect pool installation. Fluidra Connect does not work without Connect Box, which must have a cable or Wi-Fi Internet connection (from a home router, 3G network, etc.).

	Code	Standard Pack	Standard weight in kg	Standard volume in m ³
Connect Box	66671	1	0.42	0.0010

GPIO



DESCRIPTION

Control device with 4 digital inputs and 4 digital outputs.

Using the GPIO, incompatible products, such as a white spotlight or filtration pump, can be switched on or off and their timers set.

It also displays the status of some devices, such as a pool cover.

	Code	Standard Pack	Standard weight in kg	Standard volume in m ³
GPIO	62368	1	0.18	0.0003



When the products to be controlled are not "NN Things", they can be managed using a GPIO device.

CONNECT & GO EXPANSION MODULES

Expansion modules

2 auxiliary pumps



FLUIDRA
CONNECT
INTERNET OF POOLS

DESCRIPTION

Those expansion modules allow to add ON-OFF-AUTO control of 2 additional pumps.
Available in 3 versions for 1, 2 or 3 HP pumps (single phase).

	Code	Standard Pack	Standard weight in kg	Standard volume in m ³
Expansion module - 2 pumps 1 HP	72731	1	3.00	0.028
Expansion module - 2 pumps 2 HP	72732	1	3.00	0.028
Expansion module - 2 pumps 3 HP	72733	1	3.00	0.028

Expansion modules

White & RGB lighting



FLUIDRA
CONNECT
INTERNET OF POOLS

DESCRIPTION

Those expansion modules allow to add Lighting supply and control.
Provided with a 100 VA transformer.
Available in 2 versions: white light and RGB color light (NN compatible)

	Code	Standard Pack	Standard weight in kg	Standard volume in m ³
Expansion module - white light	70695	1	1.50	0.009
Expansion module - RGB color light	70696	1	1.50	0.009

Expansion module - GPIO



FLUIDRA
CONNECT
INTERNET OF POOLS

DESCRIPTION

This expansion module allows to add a GPIO device that brings 4 digital inputs and 4 digital outputs in addition to existing GPIO in Connect & Go cabinets.

Any standard product can be managed with ON, OFF and schedule controls or device status (such as pool cover for example).

	Code	Standard Pack	Standard weight in kg	Standard volume in m ³
Expansion module - GPIO	70770	1	3.00	0.020

Accessories

	Code	Standard Pack	Standard weight in kg	Standard volume in m ³
230 VAC opto-isolator	66395	1	-	-
24 VAC opto-isolator	66396	1	-	-
Switch - 5 ports	66390*	1	-	-
Power Line Communications - 2 ports	66391*	1	-	-
Indoor Wi-Fi access point	66392*	1	-	-
Outdoor router	66393*	1	-	-
Portable router	66394*	1	-	-
3G router (requires SIM card)	67297*	1	-	-
3G router for DIN rail (requires SIM card)	67298*	1	-	-
SEM1 single-phase meter with transformer	68441	1	-	-
SEM3 single-phase meter with 3 transformers	68442	1	-	-
Bridge Modbus TCP/RTU	68168	1	-	-
Modbus temperature sensor kit	69682	1	-	-

* Available while stock lasts.



66395 - 66396



66390



66391



66392



66393



66394



67297



68441-68442



68168



POOL SURROUND EQUIPMENT



38	POOL ACCESS	53	SHOWERS
38	Elegance ladders	53	Chrome showers
38	Komfi ladders	55	Pluvium showers
39	Wall model ladders	56	Iguazu showers
40	Standard model ladders	57	Solar showers
41	Mixed model ladders	58	Knob valves
42	Asymmetrical and easy access ladders	60	Showers with timers
44	Exit grab rails and lower end	61	Accessories
46	Accessories, anchoring fixtures and grips	62	Shower trays
48	DIVING BOARDS AND TRAMPOLINES	63	ASTRALPOOL BIKE
49	PLATFORMS	64	ORNAMENTAL WATER FEATURES - CANNONS AND WATERFALLS
50	SLIDES	69	GRILLES FOR OVERFLOW

POOL ACCESS

Elegance ladders



Complies with Standard EN 16582-1:2015

DESCRIPTION

These sleek, stylish ladders with handrails have been designed to make it easy to get into a pool. Made of AISI 316L stainless steel with two anchoring points, the first step is double the standard size in a non-slip material for the greater safety and convenience of swimmers. Comes with 3 or 4 steps. To connect ground earth cable use Equipotential Anchor items 73318 or 73319.

	Code	Standard Pack	Standard weight in kg	Standard volume in m ³
Elegance ladders				
2 steps + 1 safety step	45782	1	14	0.089
3 steps + 1 safety step	45783	1	15	0.089

TECHNICAL FEATURES

Reference	Steps	A	B
45782	2 + 1 safety	960	2430
45783	3 + 1 safety	1220	2690

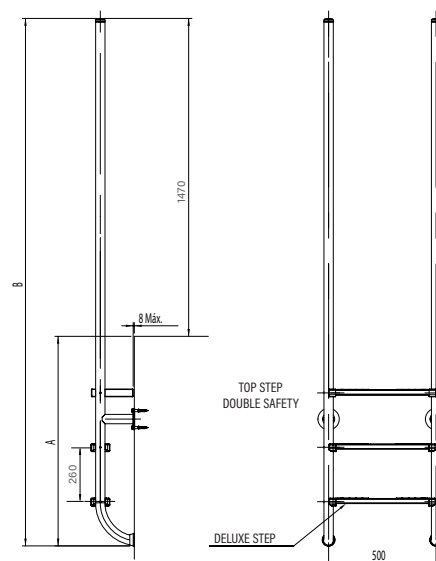

POOL ACCESS

Komfi ladders



Complies with Standard EN 16582-1:2015

DESCRIPTION

Standard Ladder grey step

Ladder with handrails manufactured in Ø43 and polished AISI-316L stainless steel tube.

Polypropylene steps. Its plastic steps ensure a comfortable tread when the user steps on. It also avoids the possibility of slipping.

Material: Stainless Steel AISI 316L polished handrail + polypropylene steps

Dimensions: based on Standard ladders for Residential use.

	Code	Standard Pack	Standard weight in kg	Standard volume in m ³
2 steps	73147	1	9,8	0.066
3 steps	73148	1	13	0.076
4 steps	73149	1	14	0.086
5 steps	73150	1	15	0.097

*** 1 additional year warranty. For more information see the warranty certificate in the manual.**

Wall model ladders



- In-ground pool ladder.
- Stainless steel Ø 43 mm pipe handrail.
- Stainless steel steps.
- Special non-slip design ensures safety.
- Supplied with anchoring fixtures for connection to an equipotential outlet.
- Trimmed faceplate.

TECHNICAL FEATURES

Steps	A	B	C	D	E	F
2	318	620	260	700	148	500
3	318	620	260	960	148	500
4	318	620	260	1220	148	500
5	318	620	260	1480	148	500

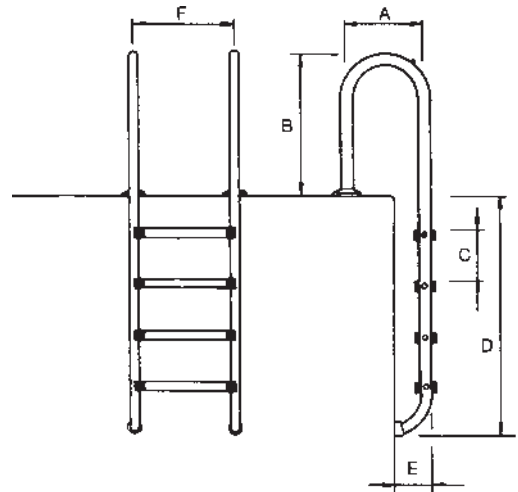

Complies with Standard
EN 16582-1:2015



Wall model ladder with Luxe model steps



DESCRIPTION

Rails & steps in AISI-316L.



	Code	Standard Pack	Standard weight in kg	Standard volume in m ³
2 steps ladder	05480	1	9.0	0.05
3 steps ladder	05481	1	10.5	0.06
4 steps ladder	05482	1	12.4	0.06
5 steps ladder	05483	1	13.7	0.07



Wall model ladder with Standard model steps



DESCRIPTION

Rails & steps in AISI-304L.

	Code	Standard Pack	Standard weight in kg	Standard volume in m ³
2 steps ladder	05492	1	9.0	0.05
3 steps ladder	05493	1	12.7	0.06
4 steps ladder	05494	1	14.8	0.06
5 steps ladder	05495	1	13.6	0.07

*** 1 additional year warranty. For more information see the warranty certificate in the manual.**

POOL ACCESS

Standard model ladders



- In-ground pool ladder. Stainless steel Ø 43 mm pipe handrail.
- Stainless steel steps. Special non-slip design ensures safety.
- Supplied with anchoring fixtures for connection to an equipotential outlet.
- Trimmed faceplate.



Complies with Standard EN 16582-1:2015

Optional: American measurements without anchor point and optional plastic step.

TECHNICAL FEATURES

Steps	A	B	C	D	E	F
2	618	620	260	700	148	500
3	618	620	260	960	148	500
4	618	620	260	1220	148	500
5	618	620	260	1480	148	500

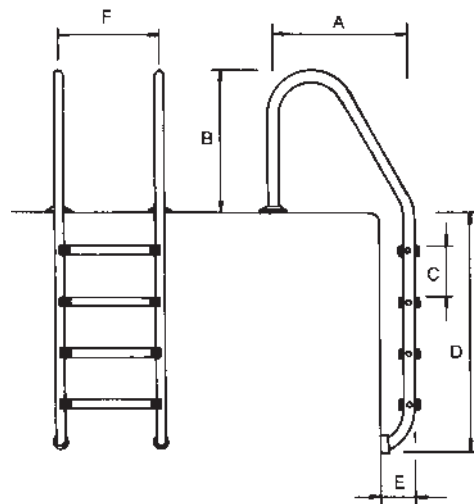

Standard handrail ladder with Luxe model step



DESCRIPTION

Rails & steps in AISI-316L.



	Code	Standard Pack	Standard weight in kg	Standard volume in m ³
2 steps ladder	05476	1	9.8	0.07
3 steps ladder	05477	1	11.5	0.08
4 steps ladder	05478	1	14.0	0.08
5 steps ladder	05479	1	15.0	0.10



Standard handrail ladder with Standard model step



DESCRIPTION

Rails & steps in AISI-304L.

	Code	Standard Pack	Standard weight in kg	Standard volume in m ³
2 steps ladder	05488	1	9.6	0.07
3 steps ladder	05489	1	12.0	0.08
4 steps ladder	05490	1	15.0	0.09
5 steps ladder	05491	1	15.0	0.09

* 1 additional year warranty. For more information see the warranty certificate in the manual.

Mixed model ladders



- In-ground pool ladder.
- Stainless steel Ø 43 mm pipe handrail.
- Stainless steel steps. Special non-slip design ensures safety.
- Supplied with anchoring fixtures for connection to an equipotential outlet.
- Trimmed faceplate.



Complies with Standard
EN 16582-1:2015

TECHNICAL FEATURES

Steps	A	B	C	D	E	F	G
2	318	620	260	700	148	500	491
3	318	620	260	960	148	500	491
4	318	620	260	1220	148	500	491
5	318	620	260	1480	148	500	491

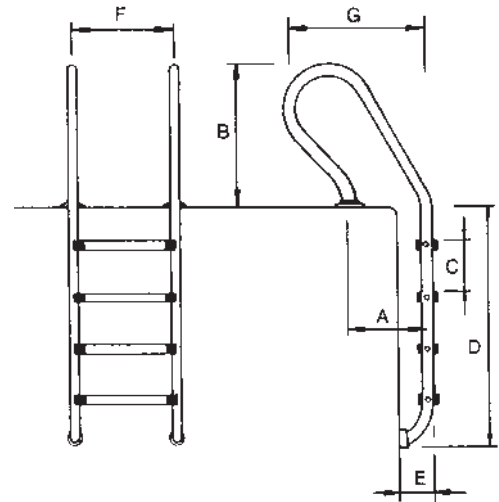

Mixed handrail ladder with Luxe model step



DESCRIPTION

Rails & steps in AISI-316L.



	Code	Standard Pack	Standard weight in kg	Standard volume in m ³
2 steps ladder	05484	1	9.7	0.07
3 steps ladder	05485	1	11.5	0.08
4 steps ladder	05486	1	12.6	0.09
5 steps ladder	05487	1	14.8	0.09



Mixed handrail ladder with Standard model step



DESCRIPTION

Rails & steps in AISI-304L.

	Code	Standard Pack	Standard weight in kg	Standard volume in m ³
2 steps ladder	05496	1	9.7	0.07
3 steps ladder	05497	1	11.4	0.08
4 steps ladder	05498	1	15.3	0.09
5 steps ladder	05499	1	14.8	0.10

*** 1 additional year warranty. For more information see the warranty certificate in the manual.**

Asymmetrical and easy access ladders

Standard asymmetrical model



Complies with Standards
EN 13451-1
EN 13451-2



DESCRIPTION

Standard model ladder for embedded pools. Handrails in polished Stainless Steel (Ø 43 mm) pipe. Stainless steel steps with non-slip surface. Its careful design helps to reduce the danger of slips or cuts. Complete with anchoring fixtures and earthing connection. Rails & steps in AISI-316L.

	Code	Standard Pack	Standard weight in kg	Standard volume in m ³
1 "Luxe" step + 1 double safety step	19938	1	13.0	0.07
2 "Luxe" steps + 1 double safety step	19939	1	13.9	0.08
3 "Luxe" steps + 1 double safety step	19940	1	15.8	0.10
4 "Luxe" steps + 1 double safety step	19941	1	17.0	0.10

TECHNICAL FEATURES

Code	Steps	A	B
19938	2	1450	700
19939	3	1710	960
19940	4	1970	1220
19941	5	2230	1480

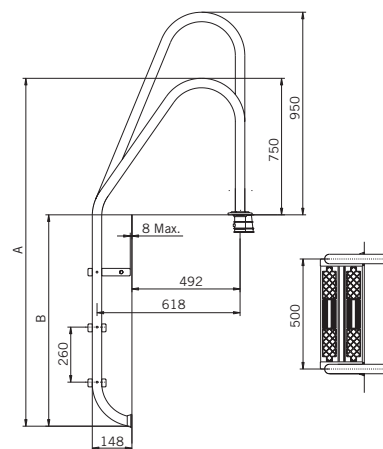

Complies with Standards
EN 13451-1
EN 13451-2



Mixed asymmetrical model



DESCRIPTION

Stairs with Mixed model handrails, for embedded pools, made of polished Stainless Steel (Ø 43 mm) pipe. Its careful design helps to reduce the danger of slips or cuts. Complete with anchoring fixtures and earthing connection. LUXE handrails and steps in AISI-316L.

	Code	Standard Pack	Standard weight in kg	Standard volume in m ³
2 "Luxe" steps + 1 double safety step	19943	1	14.0	0.08
3 "Luxe" steps + 1 double safety step	19944	1	15.6	0.09
4 "Luxe" steps + 1 double safety step	19945	1	17.5	0.10

TECHNICAL FEATURES

Code	Steps	A	B
19943	3	1710	960
19944	4	1970	1220
19945	5	2230	1480

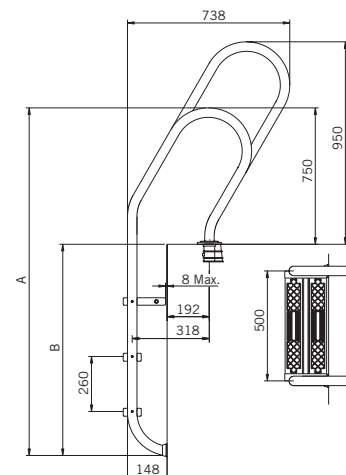

Asymmetrical and easy access ladders

Easy access model



DESCRIPTION

Ladder width of 500 mm. Handrails in polished stainless steel (Ø 43 mm) pipe. With anchoring fixtures and earthing connection. Polished finish. With anchoring fixtures for earth connection. Rails and non-slip steps in polished AISI-316L.

	Code	Standard Pack	Standard weight in kg	Standard volume in m ³
3-step ladder	07782	1	21.6	0.145
4-step ladder	11979	1	25.9	0.202

TECHNICAL FEATURES

Code	Steps	A	B	C	D	E	F
07782	3	1835	750	260	243	490	500
11979	4	2085	750	260	243	490	500

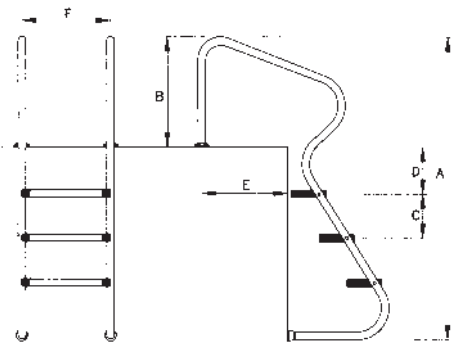

Above-ground pool safety ladder with platform



DESCRIPTION

Ladder manufactured in AISI-304L stainless steel Ø43 pipe with a bright satin finish and plastic treads. White steps and plastic platform. Non-slip steps and platform. Safe pool access. Ladder maximum load: 150 kg.

	Code	Standard Pack	Standard weight in kg	Standard volume in m ³
For above-ground pool height 1 m	67656	1	-	-
1.20 or 1.35 m	67657	1	-	-
1,50 m	67658	1	-	-



Complies with Standard EN 16582-1:2015

For above-ground pool height

TECHNICAL FEATURES

Code	Steps	A	B	C	D	E	F	G	H	I	J	K
67656	3	1856	1204	400	317	1000	400	317	1433	344	506	797
67657	4	2094	1442	350	285	1350	350	285	1644	344	506	808
67658	5	2378	1727	350	285	1500	350	285	1899	344	506	805

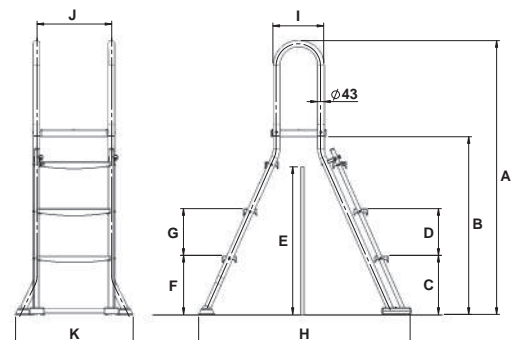

Ladders and grab rails made to measure. Any types of ladders, grab rails and handrails can be made to order out of AISI-304L and AISI-316L stainless steel adapted to your needs.

POOL ACCESS

Exit grab rails and lower end



800 x 800 mm model



DESCRIPTION

Set of 2 tubular handrails in polished S.S. AISI-316L Ø 43 mm pipe. Exit grab rails with fixing plates are supplied as a pair including fixing plates, gaskets, screws and wall plugs.

	Code	Standard Pack	Standard weight in kg	Standard volume in m ³
Attachment by means of fixing plate	05541	1	9.27	0.10
Attachment for embedding	05540	1	8.40	0.10



470 x 800 mm model



DESCRIPTION

Set of 2 tubular handrails in polished S.S. AISI-316L Ø 43 mm pipe. Exit grab rails with fixing plates are supplied as a pair including fixing plates, gaskets, screws and wall plugs.

	Code	Standard Pack	Standard weight in kg	Standard volume in m ³
Attachment by means of fixing plate	05542	1	6.97	0.08



470 x 800 mm model with rectangular base plate



DESCRIPTION

Set of 2 tubular handrails in polished S.S. AISI-316L Ø 43 mm pipe. The exit grab rails with base plates are supplied with screws and wall plugs.

	Code	Standard Pack	Standard weight in kg	Standard volume in m ³
Attachment by means of fixing plate	05543	1	7.6	0.08



Crossover model with rectangular base plate



DESCRIPTION

Set of 2 tubular handrails in polished S.S. AISI-316L Ø 43 mm pipe. The exit grab rails with base plates are supplied with wall plugs and screws.

	Code	Standard Pack	Standard weight in kg	Standard volume in m ³
Attachment by means of fixing plate	05544	1	8.46	0.18

Exit grab rails and lower end

Parallel model



DESCRIPTION

Set of 2 x AISI-316L bright satin stainless steel Ø 43 mm pipe handrails. For fastening with anchoring fixtures code 00143 (not included in supply, see page 46).

	Code	Standard Pack	Standard weight in kg	Standard volume in m ³
Parallel model	00110	1	10.0	0.11

Asymmetrical model



DESCRIPTION

Set of 2 tubular handrails in polished S.S. AISI-316L Ø 43 mm pipe. For fixing with anchoring fixture code 00143 (not included, see page 46).

	Code	Standard Pack	Standard weight in kg	Standard volume in m ³
Asymmetrical model	00111	1	10.1	0.14

Split ladder - Bottom half



Complies with Standard EN 16582-1:2015

DESCRIPTION

Rails and steps in polished AISI-316L stainless steel (Ø 43 mm). Attachment with fixing plates, gaskets, screws and wall plugs. To connect ground earth cable use Equipotential Anchor items 73318 or 73319.

	Code	Standard Pack	Standard weight in kg	Standard volume in m ³
2 "Luxe" steps	01456	1	5.0	0.04
3 "Luxe" steps	01457	1	6.3	0.04
4 "Luxe" steps	01458	1	7.7	0.05
5 "Luxe" steps	01459	1	9.2	0.07

Grab rail fixed out of the water



Complies with Standard EN 13451-1 EN 13451-2

DESCRIPTION

In polished AISI-316L stainless steel (Ø 43 mm).

	Code	Standard Pack	Standard weight in kg	Standard volume in m ³
For embedding	07780	1	6.7	0.118
With base plates (gaskets, wall plugs and screws)	07781	1	6.7	0.118

* 1 additional year warranty. For more information see the warranty certificate in the manual.

POOL ACCESS

Accessories, anchoring fixtures and grips

Double non-slip safety step



DESCRIPTION

AISI-316L stainless steel with bright satin finish. For all in-ground pool ladder models.

	Code	Standard Pack	Standard weight in kg	Standard volume in m ³
Safety step	70662	1	2.05	0.003

Anchoring sockets



DESCRIPTION

In plastic, with connection to an equipotential circuit.

	Code	Standard Pack	Standard weight in kg	Standard volume in m ³
For Ø 43 mm pipe.	00042	50	7.0	0.03
For Ø 48 mm pipe.	07661	-	-	-

Articulated anchoring sockets



00043

08727



DESCRIPTION

In polished Stainless Steel (AISI-304L) for a ladder with a Ø 43 mm pipe.

	Code	Standard Pack	Standard weight in kg	Standard volume in m ³
Articulated anchoring socket without base plate	00043	1	0.93	0.002
with base plate	08727	1	1.0	0.002

Removable anchoring socket with base plate



DESCRIPTION

In polished stainless steel (AISI-316L) for a Ø 43 mm pipe with gaskets, wall plugs and screws.

	Code	Standard Pack	Standard weight in kg	Standard volume in m ³
Set of 2 units	07331	1	1.00	0.003

Anchor with locking bolts



DESCRIPTION

Made of polished AISI-316L stainless steel. For a Ø 43 mm pipe.

	Code	Standard Pack	Standard weight in kg	Standard volume in m ³
Anchoring sockets	00143	2	1.2	0.003

Accessories, anchoring fixtures and grips



Ladder foot pad



DESCRIPTION

Made of plastic, the angle can be adjusted by rotating the eye ball socket. Recommended for liner pools.

	Code	Standard Pack	Standard weight in kg	Standard volume in m ³
For Ø 43 mm pipe.	00045	50	12.6	0.03
For Ø 28 mm pipes.	00046	50	14.0	0.03

Stainless Steel Handrails



DESCRIPTION

Polished Ø 43 mm AISI-316L stainless steel pipes. With fixing plates (including gaskets, screws and wall plugs).

	Code	Standard Pack	Standard weight in kg	Standard volume in m ³
Length 0.5 m	00051	2	2.8	0.02
Length 1 m	00052	2	4.3	0.04
Length 2 m	00053	2	7.9	0.09
Length 2.5 m	00054	2	9.5	0.11

Tee bar



DESCRIPTION

Polished Ø 43 mm AISI-316L stainless steel pipes.

	Code	Standard Pack	Standard weight in kg	Standard volume in m ³
With fixing plates (including gaskets, screws and wall plugs).	00056	1	2.09	0.01

Equipotential anchor



DESCRIPTION

The aim of this accessory for ladders is to solve the problem of not having the possibility to connect ground earth cable to ladders that do not have an anchoring on the pool beach like: Elegance and split ladders - items 45782, 45783, 01456, 01457, 01458, 01459, 08090, 08091 and 08092.

It is mandatory by norms to connect metallic ladders to ground earth in order to have proper electrical connections. Moreover, it is highly recommended to avoid corrosion.

Equipotential anchor for ladders, manufactured in AISI-304L stainless steel and commercialized for concrete and liner pools. The anchors are composed of a recessed base on the ground, washer, screws and the equipotential bonding.

Each ladder needs to 2 units.

	Code	Standard Pack	Standard weight in kg	Standard volume in m ³
Concrete pools	73318	1	0.45	0.002
Liner pools	73319	1	0.50	0.002

Dynamic flexible springboard



DESCRIPTION

Wide springboard made of polyester resin and fibreglass. Resistant to UV exposure and adverse weather conditions. Non-slip surface covering the entire board. Supplied with anchoring fixtures.

	Code	Standard Pack	Standard weight in kg	Standard volume in m ³
Length 1.61 m. Width 0.46 m	21392	1	22.0	0.335

Dynamic 1200 Diving Board



DESCRIPTION

Wide springboard made of polyester resin and fibreglass. Resistant to UV exposure and adverse weather conditions. Non-slip surface covering the entire board. Supplied with anchoring fixtures.

	Code	Standard Pack	Standard weight in kg	Standard volume in m ³
Length 1.20 m. Width 0.40 m	20090	1	20.0	0.325

Dynamic Diving Board



DESCRIPTION

Wide springboard made of polyester resin and fibreglass, with non-slip surface. Grab rails and supports made of stainless steel with matt finish. Supplied with anchoring fixtures.

	Code	Standard Pack	Standard weight in kg	Standard volume in m ³
Length 2 m, Width 0.60 m	23199	1	50.0	1.585
Length 2.30 m, Width 0.60 m	23200	1	52.0	1.585

Dolphin Model



DESCRIPTION

Flexible Polyester and fibreglass springboard in light blue. Supplied with anchoring fixtures.

	Code	Standard Pack	Standard weight in kg	Standard volume in m ³
Length 1.6 m. Height 0.35 m	00076	1	22.0	0.138

Ballesta Model

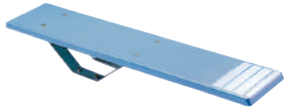

DESCRIPTION

Light blue Polyester and fibreglass springboard. Springboard bracket made of galvanized Steel. Supplied with anchoring fixtures.

	Code	Standard Pack	Standard weight in kg	Standard volume in m ³
Length 1.8 m, Height 0.25 m, Width 0.4 m	00077	1	27.0	0.084
Length 1.4 m, Height 0.25 m, Width 0.4 m	00078	1	25.0	0.072

Elevated Model



DESCRIPTION

Base laminated in ivory-coloured Polyester and fibreglass, with light blue board. With 2 stainless steel handrails. Non-slip step and board. Supplied with anchoring fixtures.

	Code	Standard Pack	Standard weight in kg	Standard volume in m ³
Length 2 m Height 0.55 m Width 0.4 m	00068	1	38.0	0.850
Length 2.5 m Height 0.75 m Width 0.46 m	00069	1	68.0	1.380

PLATFORMS

Platform

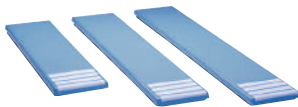

DESCRIPTION

Light blue polyester and fibreglass boards with non-slip surface. Anchoring fixtures are not supplied.



	Code	Standard Pack	Standard weight in kg	Standard volume in m ³
Width 0.40 m				
Length 1.4 m	00060	1	13.0	0.036
Length 1.8 m	00061	1	16.0	0.046
Length 2.0 m	00062	1	18.0	0.050
Length 2.3 m	00063	1	22.0	0.060
Width 0.46 m				
Length 2.5 m	00064	1	31.0	0.080
Length 3.2 m	00065	1	46.0	0.100

Diving board brackets



DESCRIPTION

Made of polished AISI-304L stainless steel, with platform fixing bolts.

	Code	Standard Pack	Standard weight in kg	Standard volume in m ³
For boards up to 2.30 m in length	14586	1	8.0	0.040
For boards from 2.5 to 3.2 m in length	72594	1	8.4	0.102

SLIDES

Pranaslide Model



DESCRIPTION

Light blue polyester and fibreglass steps and slide. Grab rails made of white painted Aluminium. Fitted with a water supply connection to ease sliding. Supplied with anchoring fixtures.

	Code	Standard Pack	Standard weight in kg	Standard volume in m ³
Height 1.50 m	00085	1	62.0	1.214
Height 1.80 m	00086	1	70.0	1.368



Curved model



DESCRIPTION

Light blue polyester and fibreglass steps and slide. Grab rails made of white painted Aluminium. Fitted with a water supply connection to ease sliding. Supplied with anchoring fixtures

	Code	Standard Pack	Standard weight in kg	Standard volume in m ³
Right curve, height 1.78 m	00088	1	83.0	2.913
Left curve, height 1.78 m	00089	1	83.0	2.913

Straight model



DESCRIPTION

Light blue polyester and fibreglass slide. Plastic steps. Polished stainless steel handrails. Fitted with a water supply connection to ease sliding. Supplied with anchoring fixtures.

	Code	Standard Pack	Standard weight in kg	Standard volume in m ³
Height 1.30 m	00081	1	31.0	0.550
Height 1.80 m	00082	1	38.0	0.850
Height 2.00 m	00083	1	44.0	0.750

SLIDES

Slides



DESCRIPTION

Slide made of polyester, reinforced with fibreglass. Plastic steps. Stainless steel handrails. Fitted with a water supply connection to ease sliding. Supplied with anchoring fixtures. Available in white, blue and ivory.

	Code	Standard Pack	Standard weight in kg	Standard volume in m ³
Straight	18543 MT07	1	-	6.48
Left curve	18545 MT07	1	-	8.30

SLIDES

Typhoon Model



Available colours:



DESCRIPTION

Rotomolded slides with "easy grab" handrails and an enclosed non-slip ladder to ensure safe use. They are compatible with Salt Chlorination systems as indicated by the "Salt Pool Approved" label. Fitted with a water supply connection to ease sliding. Height 2.10 metres. Colour available: Sandstone.

	Code	Standard Pack	Standard weight in kg	Standard volume in m ³
Typhoon Model	52253	1	61	-

Cyclone Model



Available colours:

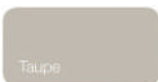

DESCRIPTION

Rotomolded slides with "easy grab" handrails and an enclosed non-slip ladder to ensure safe use. They are compatible with Salt Chlorination systems as indicated by the "Salt Pool Approved" label. Fitted with a water supply connection to ease sliding. Height 2.10 metres. Colour available: Sandstone.

	Code	Standard Pack	Standard weight in kg	Standard volume in m ³
Cyclone Model	52254	1	115	-

COMFORT & ELEGANCE FOR YOUR GARDEN

SOLAR AND NON-SOLAR CHROME SHOWERS

With an elegant, streamlined design, the AstralPool Solar and Non-Solar Chrome showers range stands out for its modern vintage style, in a wide range of colors and finishes.

You can choose the one that best fits in with your pool surroundings.

**30 l
tank**



Wide range of colors and finishes both models



Solar
Chrome Shower

Non-Solar
Chrome Shower



SHOWERS

Chrome showers

Solar Chrome Shower 30 L Tank



DESCRIPTION

With an elegant, streamlined design, the AstralPool Chrome Solar Shower stands out for its modern vintage style, in a wide range of colors and finishes so that you can choose the one that best fits in with your pool surroundings. Enjoy a relaxing experience before and after every swim thanks to its large 30 l tank to obtain hot water without consuming energy. This green solution for the daily use of your pool contributes to looking after the environment, as well as your health and that of others.

TECHNICAL SPECIFICATIONS:

- A 30 l hot water tank - The leading environmentally friendly system (sunlight heats the water) in the market.
- AISI-304-L Stainless Steel tube and Aluminum framework.
- Wide range of metallic finishes and colors.
- Anti-limescale shower head and rain effect.
- Hot and cold water mixer tap.
- Foot washer tap.
- Ease of maintenance: drainage for emptying the shower in winter to prevent damage and wear.
- Back inlet compatible with hose connection.

	Code	Standard Pack	Standard weight in kg	Standard volume in m ³
Metallic				
Shower Chrome solar Anthracite S.S.	74052	1	13.5	0.25
Shower Chrome solar silver	74052CL12	1	13.5	0.25
Shower Chrome solar Anthracite copper	74053	1	13.5	0.25
Colour range				
Shower Chrome solar blue	74052CL153	1	13.5	0.25
Shower Chrome solar red	74052CL154	1	13.5	0.25
Shower Chrome solar green	74052CL155	1	13.5	0.25
Shower Chrome solar orange	74052CL156	1	13.5	0.25

PRODUCT DETAILS - EXAMPLE OF ITEM 74053



SHOWERHEAD



MIXER TAP



FOOT WASH



74052



74053



74052CL12



74052CL153



74052CL154



74052CL155



74052CL156

SHOWERS

Chrome showers

Non Solar Chrome Shower



DESCRIPTION

Featuring the same elegant, streamlined look of its solar counterpart, the AstralPool Non-Solar Chrome Shower has a wide range of finishes that will allow you to choose the best option for your garden.

It has a shower head with an anti-limescale system and a rain effect so that you can enjoy a relaxing experience before and after every swim.

TECHNICAL SPECIFICATIONS:

- AISI-304L stainless steel tube and Aluminum framework.
- Wide range of colors.
- Anti-limescale shower head and rain effect.
- Foot washer tap.
- Easy installation: inlet underneath or back/lateral (compatible with hose connection).

	Code	Standard Pack	Standard weight in kg	Standard volume in m ³
Metallic				
Shower Chrome no solar anthracite S.S.	74054	1	9	0.11
Shower Chrome no solar silver	74054CL12	1	9	0.11
Shower Chrome no solar anthracite copper	74055	1	9	0.11
Colour range				
Shower Chrome no solar blue	74054CL153	1	9	0.11
Shower Chrome no solar red	74054CL154	1	9	0.11
Shower Chrome no solar green	74054CL155	1	9	0.11
Shower Chrome no solar orange	74054CL156	1	9	0.11

PRODUCT DETAILS - EXAMPLE OF ITEM 74055



SHOWERHEAD



MIXER TAP



FOOT WASH



74054



74055



74054CL12



74054CL153



74054CL154



74054CL155



74054CL156

Pluvium showers

Pluvium shower



DESCRIPTION

Shower made of tropical wood combined with glossy AISI-316L stainless steel. Mixer valve for hot and cold water control. Adjustable shower head with anti-limescale system. Its minimalist and compact design provides an elegant and modern image for the pool environment and its high quality materials give it a long service life and greater resistance to weathering and corrosion.

Height of the shower head from the ground: 2.04 m.

	Code	Standard Pack	Standard weight in kg	Standard volume in m ³
Pluvium Shower with shower tray	43583	1	38	0.169
Pluvium Shower without shower tray	43432	1	27	0.136



SHOWERHEAD

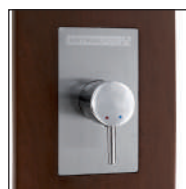

MIXER TAP

Pluvium solar shower



DESCRIPTION

Solar shower made of tropical wood combined with glossy AISI-316L stainless steel. It includes a 30 L aluminium tank. Mixer valve for hot and cold water control. Adjustable shower head with anti-limescale system. Its minimalist and compact design provides an elegant and modern image for the pool environment and its high quality materials give it a long service life and greater resistance to weathering and corrosion. Height of the shower head from the ground: 2.04 m.

	Code	Standard Pack	Standard weight in kg	Standard volume in m ³
Pluvium Solar Shower without shower tray	43435	1	37	0.225

Shower tray for Pluvium shower



DESCRIPTION

Shower tray for the Pluvium shower made of a combination of wood and glossy AISI-316L stainless steel. Its minimalist and compact design provides an elegant and modern image for the pool environment.

	Code	Standard Pack	Standard weight in kg	Standard volume in m ³
Shower tray for Pluvium shower	43434	1	11	0.028

SHOWERS

Iguazu showers

Iguazu Shower



DESCRIPTION

Matt AISI-316L stainless steel shower for hot and cold water with a white acrylic front panel. Adjustable chromed brass anti-limescale shower-head and 2 mist spray jets controlled by a 2-way control valve. The flow rate and the water temperature are regulated by a mixer valve.

	Code	Standard Pack	Standard weight in kg	Standard volume in m ³
Iguazu Shower	53874	1	27	0.163



SHOWERHEAD



MIXER TAP



BODY JETS



Iguazu Solar Shower



DESCRIPTION

Matt AISI-316L stainless steel solar shower with a white acrylic front panel. Adjustable chromed brass anti-limescale shower-head and 2 mist spray jets controlled by a 2-way control valve. With a cold water inlet, it enables the water to be heated by means of a 30 litre aluminium accumulator tank, taking advantage of the sun's energy.

	Code	Standard Pack	Standard weight in kg	Standard volume in m ³
Iguazu Solar Shower	56933	1	32	0.163



SHOWERHEAD



MIXER TAP



BODY JETS



Solar showers

- + user comfort
- + energy saving
- + easy to install

Niagara Solar Shower



DESCRIPTION

Shower made of polished AISI-304L stainless steel. With a single cold water inlet, it enables the water to be heated by means of a 30 L aluminium accumulator tank, taking advantage of the sun's energy. It has a mixer valve and a square adjustable anti-limescale shower head.

	Code	Standard Pack	Standard weight in kg	Standard volume in m ³
Niagara Solar Shower	53873	1	25	0.26

Angel Solar Shower



DESCRIPTION

Grey aluminium shower. With a cold water inlet, it enables the water to be heated by means of a 30 litre aluminium accumulator tank, taking advantage of the sun's energy. It has a mixer valve and an anti-limescale shower head.

	Code	Standard Pack	Standard weight in kg	Standard volume in m ³
Angel Solar Shower	56932	1	13	0.152



SHOWERHEAD

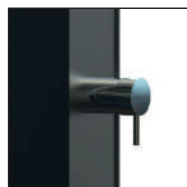

MIXER TAP

SHOWERS

Knob valves

Niagara Shower



DESCRIPTION

Shower made of polished AISI-304L stainless steel with a square adjustable shower head and a flow-regulating valve.

	Code	Standard Pack	Standard weight in kg	Standard volume in m ³
Niagara Shower	53872	1	22	0.125

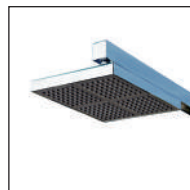

SHOWERHEAD



KNOB



RECOMMENDED

Stainless steel polish/cleaner

See P. 246

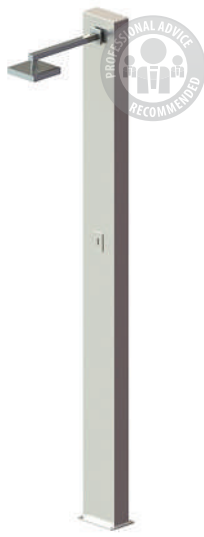

Niagara touchless shower



DESCRIPTION

The Niagara touchless shower incorporates a proximity sensor that works with battery for turning on the shower without contact. Its minimalist design and the high quality of its materials provide you with an elegant and modern image.

TECHNICAL FEATURES:

- Made of AISI-304L polished stainless steel
- Water inlet connection 1/2" BSP INT
- Ground anchoring with screws
- Touchless system with sensor detection angle 15 degrees (conical)
- 6V DC Power supply (4xAA 1.5V). Batteries not included.
- Sensor protection class IP67
- Life test 500.000 cycles
- Working pressure 1-4 bar
- Max. temperature water 75°C

	Code	Standard Pack	Standard weight in kg	Standard volume in m ³
Niagara touchless shower	74102	1	23	0.125

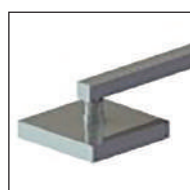
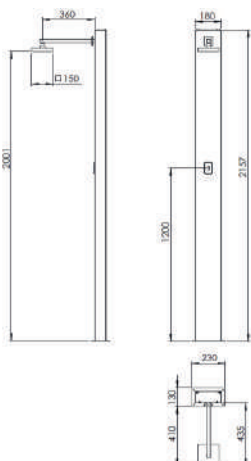

SHOWERHEAD



SENSOR

Knob valves



Angel shower with footwash



DESCRIPTION

AISI-304L polished stainless steel (Ø 43 mm) shower with 1 chrome anti-limescale showerhead and 1 flow opening valve. Includes footwash tap. With 00107 anchoring fixture incorporated (see page 61).

	Code	Standard Pack	Standard weight in kg	Standard volume in m ³
Angel footwash	52718	1	5.6	0.43



SHOWERHEAD



KNOB



FOOTWASH TAP



Angel



DESCRIPTION

AISI-304L polished stainless steel (Ø 43 mm) shower with 1 chrome anti-limescale showerhead and 1 flow opening valve. With 00107 anchoring fixture incorporated (see page 61).

	Code	Standard Pack	Standard weight in kg	Standard volume in m ³
Angel Shower	52717	1	5.6	0.43



SHOWERHEAD

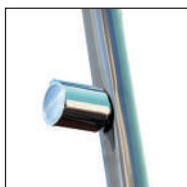

KNOB



Angel Shower with 2 shower heads



DESCRIPTION

AISI-304L polished stainless steel (Ø 63 mm) shower with 2 chrome anti-limescale showerheads and 2 flow opening valves. With 27333 anchoring fixture incorporated (see page 61).

	Code	Standard Pack	Standard weight in kg	Standard volume in m ³
Angel Shower with 2 shower heads	59775	1	9.58	0.054

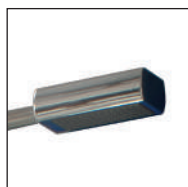

SHOWERHEAD



KNOB

Showers with timers

- AISI-304L polished stainless steel shower, specially designed for high footfall facilities (public or semi-public pools).
- AstralPool showers for public facilities are characterised by their highly resistant materials, considered vandal-proof, and the water savings made thanks to their built-in flow limiters.
- Showerhead height from floor: 2 m.
- Fastened to floor with screws, with anchoring fixture incorporated.

Shower with timer and 1 shower head



DESCRIPTION

Not designed for installation on a shower tray.

	Code	Standard Pack	Standard weight in kg	Standard volume in m ³
Shower with timer and 1 shower head	59776	1	7.2	0.044

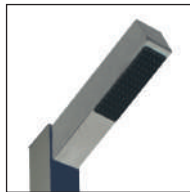

SHOWERHEAD



TIMER SWITCH

Shower with timer, 1 shower head and footwash



	Code	Standard Pack	Standard weight in kg	Standard volume in m ³
Shower with timer, 1 shower head and footwash	59777	1	7.5	0.044



SHOWERHEAD



TIMER SWITCHES

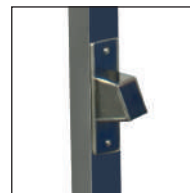

FOOTWASH TAP

SHOWERS

Showers with timers



Shower with timer and 2 shower heads



	Code	Standard Pack	Standard weight in kg	Standard volume in m ³
Shower with timer and 2 shower heads	59778	1	7.5	0.044



SHOWERHEADS



TIMER SWITCHES



The new range of timer showers has replaced the showers with code numbers 00095, 00097, 08728, 15841, 19947.

SHOWERS

Accessories

Shower anchoring fixtures



The new range of timer showers has replaced the showers with code numbers 00095, 00097, 08728, 15841, 19947.

DESCRIPTION

Made of plastic, with a locking system for shower disassembly and bonded connection.

	Code	Standard Pack	Standard weight in kg	Standard volume in m ³
Shower anchoring Ø 43 mm For models: 52717 and 52718	00107	1	0.48	0.003
Shower anchoring Ø 63 mm For model: 59775	27333	1	1.0	0.003

Shower trays

Relax model shower tray



Also available with D.63 anchoring (20067) and without anchoring (20073).

DESCRIPTION

Dimensions 80 cm x 90 cm. Large stainless steel shower tray positioned away from the standing area. Non-slip surface. Made of polyester + fibreglass. Gelcoat Finish.

	Code	Standard Pack	Standard weight in kg	Standard volume in m ³
With Ø 43 mm anchoring fixture for Angel showers 52717 and 52718 (page 59).	20066	1	9.0	0.16

Classic model shower tray

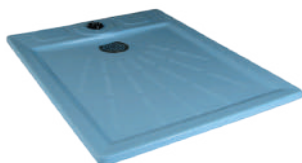

Also available with D.63 anchoring (19724) and without anchoring (19725).

DESCRIPTION

Dimensions 100 cm x 80 cm. Large stainless steel shower tray. Non-slip surface. Made of polyester + fibreglass. Gelcoat Finish.

	Code	Standard Pack	Standard weight in kg	Standard volume in m ³
With Ø 43 mm anchoring fixture for Angel showers 52717 and 52718 (page 59)	19723	1	10.0	0.16

Shower tray



Available with D.63 anchoring (code 00104).

DESCRIPTION

Dimensions 80 cm x 80 cm, with adjustable main drain. Ø 130 mm grille, Ø 50 mm connection. Made of polyester + fibreglass.

	Code	Standard Pack	Standard weight in kg	Standard volume in m ³
With Ø 43 mm anchoring fixture for Angel showers 52717 and 52718 (page 59).	00103	1	11.0	0.16

ASTRALPOOL BIKE

AstralPool Bike

ASTRALPOOL 



DESCRIPTION

Aquabike made of square and rectangular polished AISI-316L stainless steel pipe. Ideal for gyms, wellness centres, spas, medical facilities, hotels and private pools.

- Adjustable height of saddle and handlebar.
- For use in public and residential pools from 1 to 1.5 metres in depth.
- Ergonomic.
- Pedals made of PUR.
- Easy to move about.

	Code	Standard Pack	Standard weight in kg	Standard volume in m ³
AstralPool Bike	67333	1	20	0.12

Pluvium water features and ornaments



NOTE: The water features do NOT include anchoring, a pump, control panel or suction system.

DESCRIPTION

The water features in the AstralPool Signature range add a touch of elegance and design to any pool, not to mention their main purpose: increasing swimmers' feeling of wellbeing. We are proud to present the PLUVIUM cannon and waterfall. They combine wood and satin finish AISI 316L stainless steel. These products match others AstralPool Signature Pluvium shower range. 3-year warranty.

	Code	Standard Pack	Standard weight in kg	Standard volume in m ³
Pluvium cannon, 7 m ³ /h, 5 mca.	45868	1	11	0.089
Pluvium waterfall, 12 m ³ /h, 2 mca.	45869	1	31	0.284

The following fastening systems are recommended:

	Code	Standard Pack	Standard weight in kg	Standard volume in m ³
Pluvium cannon anchoring	45872	1	2	0.005
Pluvium waterfall anchoring	45873	1	3.5	0.015

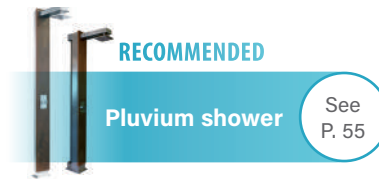

A-350 and A-500 residential water curtains



NOTE: The water features do not include a pump, control box or suction pipes.

DESCRIPTION

- Range of ornamental fountains to enhance pool design.
- Made of AISI-304L and AISI-316L stainless steel.
- Polished finish.
- Fastened to the ground with screws and anchor studs.
- 1½" ext. R. connection.

	Code	Standard Pack	Standard weight in kg	Standard volume in m ³
Residential water curtain				
A-350 AISI-316L	65104	1	10	-
A-500 AISI-316L	65105	1	13	-
A-350 AISI-304L	65106	1	10	-
A-500 AISI-304L	65107	1	13	-

NOTE: The water features do not include a pump, control box or suction pipes.

- Range of cascades for residential pools made of AISI-316L stainless steel.
- The range is made up of three cascades in an outstanding modern design.
- Polished + matt finish.
- All models come with anchoring. A ½ HP pump is recommended.



Classic water curtain



	Code	Standard Pack	Standard weight in kg	Standard volume in m ³
Classic water curtain	57095	1	28	0.38



Straight water curtain



	Code	Standard Pack	Standard weight in kg	Standard volume in m ³
Straight water curtain	57096	1	36	0.25



One water curtain



	Code	Standard Pack	Standard weight in kg	Standard volume in m ³
One water curtain	57097	1	36	0.25



RECOMMENDED

Victoria Plus Silent pump

See
P. 202

Residential water curtain



NOTE: The water features do not include a pump, control box or suction pipes.

DESCRIPTION

Residential water curtain in polished stainless steel. Fastened to the ground with screws and anchor studs.

	Code	Standard Pack	Standard weight in kg	Standard volume in m ³
AISI-316L stainless steel				
A-350, 12 m ³ /h, 2 mca	52244	1	10	0.12
A-500, 18 m ³ /h, 2 mca	52245	1	15	0.24

TECHNICAL FEATURES

Code	Suction concrete	Variable speed	Control box	*Optional Push button + Switch
52244	00302 x 2	65560	25719	04047 + 04050
52245	00302 x 2	65562	25719	04047 + 04050

* See page 613.

** Optional: components for turning the waterfall on from the pool.

Residential water cannon



NOTE: The water features do not include a pump, control box or suction pipes.

DESCRIPTION

Residential water cannon in polished stainless steel. Fastened to the ground with screws and anchor studs.

	Code	Standard Pack	Standard weight in kg	Standard volume in m ³
AISI-316L stainless steel				
Round opening. 5 m ³ /h, 2 mca	52242	1	3	0.12
Flat opening. 15 m ³ /h, 2 mca	52243	1	5	0.13
AISI-304L stainless steel				
Round opening. 5 m ³ /h, 2 mca	52238	1	3	0.12
Flat opening. 15 m ³ /h, 2 mca	52239	1	5	0.13

TECHNICAL FEATURES

Code	Suction concrete	Pump	Control box	*Optional Push button + Switch
52242	00302	65557	25718	04047 + 04050
52243	00302 x 2	65566	25719	04047 + 04050
52238	00302	65557	25718	04047 + 04050
52239	00302 x 2	65560	25719	04047 + 04050

*Optional: components for turning the cannon on from the pool.



Ornamental waterfalls



DESCRIPTION

In AISI-316L stainless steel.

	Code	Standard Pack	Standard weight in kg	Standard volume in m ³
Width (W) 300 mm, 1½" connection (B)	05577	1	6.9	0.06
Width (W) 600 mm, 2" connection (B)	05578	1	11.9	0.09

TECHNICAL FEATURES

Code water feature	Face plate	Anchoring sockets		Suction		Pump	Control box		
		Concrete	Liner	Concrete	Liner		Manual push button	Pneumatic push button	
								Concrete	Liner
05577	-	-	-	19987 x 1	20091 x 1	38770	19988	07669	07868
05578	-	-	-	19987 x 2	20091 x 2	38776	19989	17154	17155

Note: The pneumatic push button includes: control box, wall conduits and push button.

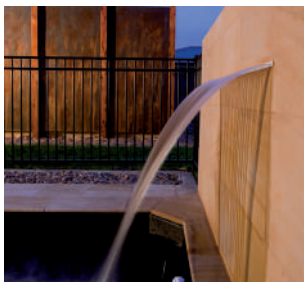

SilkFlow waterfalls



DESCRIPTION

Waterfall made of corrosion resistant ABS. Can be fed through the return circuit of the pool filter or through a specific pump.

	Code	Standard Pack	Standard weight in kg	Standard volume in m ³
300 mm waterfall	45205	1	1.19	0.012
600 mm waterfall	45206	1	2.36	0.021
900 mm waterfall	45207	1	3.45	0.003
1200 mm waterfall	45208	1	4.62	0.004

TECHNICAL FEATURES

Code	Required water flow l/min	Standard pump size HP	A Length of waterfall	B Width of waterfall over the pool surface, at the recommended rate of l/min/m	C Recommended height for the waterfall	D Distance of the water at the recommended rate of l/min/m
45205	50	0,5	300 mm	200 mm	300 mm	300 mm
45206	100	0,5	600 mm	500 mm	600 mm	300 mm
45207	150	0,75	900 mm	800 mm	900 mm	300 mm
45208	200	0,75	1200 mm	1100 mm	900 mm	300 mm

GENERAL NOTE FOR ALL MODELS

Made of PP stabilized against UV rays. The whole range comes in white. Ask your dealer about other colours.

Made up of tiles in modules for straight and curved sections (outer radius of 1 or 2 m), they click into place (male-female fitting), which gives certain leeway in assembling them, as well as absorbing their potential expansion due to the temperature changes to which they are exposed.

For all models of grating, a channel 5 mm wider than the grating must be built so that it easily fits into place and any potential expansion is prevented.

Channel width	Grating width
200.....	195
250.....	245
300.....	295
350.....	345

The height (h) of the grating varies depending on the model.

- Longitudinal model h = 24 mm
- Transversal model h = 22 mm and h = 35 mm

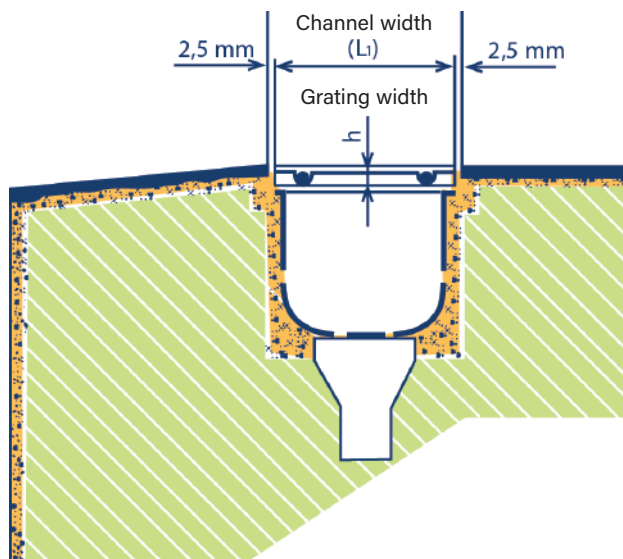

LONGITUDINAL MODEL

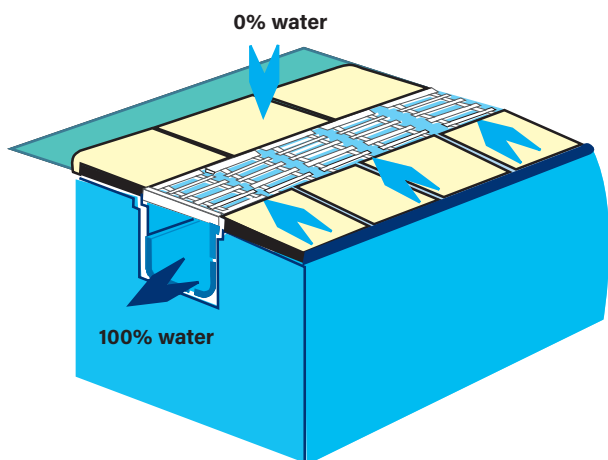

The longitudinal design of this model ensures that any excess water from the pool is not allowed to overflow onto the pool deck, thus maintaining it practically dry.

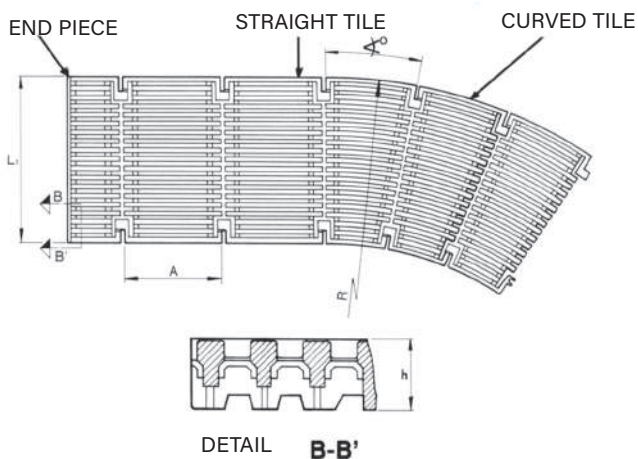

	Model	L	L1	h	A	∠ r.1m.	∠ r.2m.
STRAIGHT TILE	05581	200	195	24	206	-	-
	05582	250	245	24	206	-	-
	05583	300	295	24	206	-	-
	05584	350	345	24	206	-	-
END PIECE	06420	200	195	24	-	-	-
	06421	250	245	24	-	-	-
	06422	300	295	24	-	-	-
	06423	350	345	24	-	-	-
CURVED TILE	08001	200	195	24	-	x	
	08002	300	295	24	-	x	
	07565	250	245	24	-	x	
	07566	350	345	24	-	x	
	05585	200	195	24	-		x
	05586	250	245	24	-		x

Other grating colours can be made to order. For further information, ask your AstralPool dealer.

GRILLES FOR OVERFLOW



Longitudinal grating tile



DESCRIPTION

Made of PP stabilized against UV rays. Grating fastened together using male-female hooks (5 units = 1,024 meters). The flexible properties of the grating means a radius of up to 5 m can be covered.

	Code	Standard Pack	Standard weight in kg	Standard volume in m ³
Height 24 mm, width 195 mm	05581	45	16.2	0.080
Height 24 mm, width 245 mm	05582	29	13.4	0.080
Height 24 mm, width 291 mm	05583	28	15.6	0.080
Height 24 mm, width 345 mm	05584	19	13.2	0.080



Curved grating tile



DESCRIPTION

Made of PP stabilized against UV rays. Grating fastened together using male-female hooks.

	Code	Standard Pack	Standard weight in kg	Standard volume in m ³
Height L L1 Radius				
24 mm 200 mm 195 mm 1 m	08001	60	17.2	0.079
24 mm 300 mm 295 mm 1 m	08002	32	14.6	0.079
24 mm 250 mm 245 mm 1 m	07565	42	17.2	0.079
24 mm 350 mm 345 mm 1 m	07566	24	13.4	0.079
24 mm 200 mm 195 mm 2 m	05585	48	17.2	0.079
24 mm 250 mm 245 mm 2 m	05586	30	14.2	0.079

End piece kit for parallel grating



DESCRIPTION

Made of AISI-304 stainless steel plate, with end piece and longitudinal grating made of PP stabilized against UV rays. Made so that the grating in the end piece can be cut to fit in place.

	Code	Standard Pack	Standard weight in kg	Standard volume in m ³
Height 24 mm, width 195 mm	16064	15	5.11	0.002
Height 24 mm, width 245 mm	16065	12	5.17	0.002
Height 24 mm, width 291 mm	16066	8	4.21	0.002
Height 24 mm, width 345 mm	16067	8	5.00	0.002

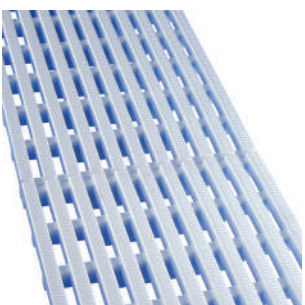

Perimeter grating



DESCRIPTION

Range of overflow grating for swimming pools. Made of homopolymer polypropylene, with additives for UV protection. Available in 500 mm long modules with male-female hooks for easy and fast assembly.

	Code	Standard Pack	Standard weight in kg	Standard volume in m ³
0.5 m longitudinal grating Height 22 mm Width 195 mm	28664	20	19.9	0.080

GRILLES FOR OVERFLOW

Modular transversal grating

for curves

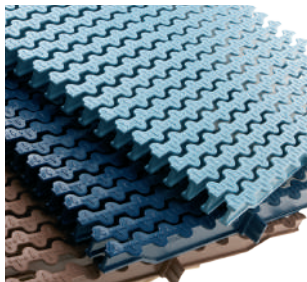
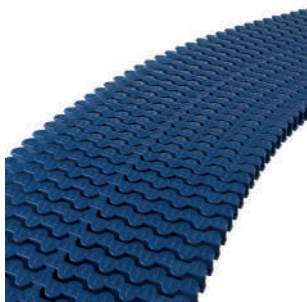

DESCRIPTION

Made of PP stabilized against UV rays. Assembled by fitting the modules together. Available in 5 colours. Other grating colours can be made to order. For further information, please contact your AstralPool dealer.

	Code	Standard Pack	Standard weight in kg	Standard volume in m ³
Modular grating for curves				
Height 22 mm, width 195 mm	34190	470	14.1	0.08
Height 22 mm, width 245 mm	34191	320	12.4	0.08
Height 22 mm, width 295 mm	34192	300	15.0	0.08
Height 22 mm, width 335 mm	34193	250	15.0	0.08
Reversible modular grating for curves				
Height 35 mm, width 195 mm	34194	450	16.0	0.08
Height 35 mm, width 245 mm	34195	300	13.7	0.08
Height 35 mm, width 295 mm	34196	290	17.3	0.08
Height 35 mm, width 335 mm	34197	250	17.4	0.08

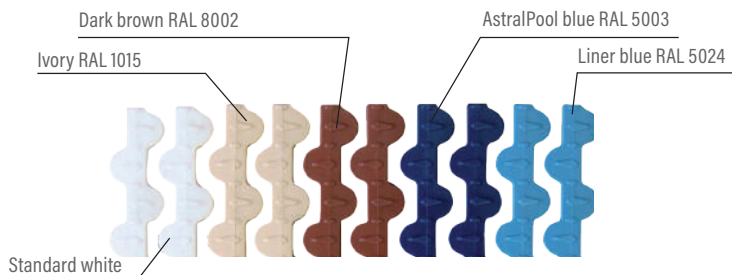

Colour	Code
White	-
RAL 1015	CL90
RAL 8002	CL109
RAL 5003	CL60
RAL 5024	CL 108

Note: Colours in the pictures are not exactly the same as in real product.

Transversal grating for curves



DESCRIPTION

Modular transversal grating for curves. Made of PP stabilized against UV rays. Assembled by fitting the modules together. Class 3 slip resistance (Rd>45) pursuant to UNE-ENV 12633: 2003.

	Code	Standard Pack	Standard weight in kg	Standard volume in m ³
Modular grating for curves				
Height 22 mm, width 195 mm	52535	470	14.1	0.08
Height 22 mm, width 245 mm	52536	320	12.4	0.08
Height 22 mm, width 295 mm	52537	300	15.0	0.08
Height 22 mm, width 335 mm	52538	250	15.0	0.08
Reversible modular grating for curves				
Height 35 mm, width 195 mm	52539	450	16.0	0.08
Height 35 mm, width 245 mm	52540	300	13.7	0.08
Height 35 mm, width 295 mm	52541	290	17.3	0.08
Height 35 mm, width 335 mm	52542	250	17.4	0.08



Other grating colours can be made to order. For further information, ask your AstralPool dealer.

Other grating colours can be made to order. For further information, ask your AstralPool dealer.

GRILLES FOR OVERFLOW

Modular transversal grating

for curves

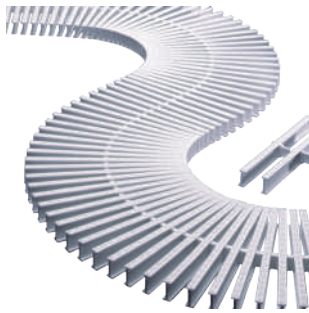

DESCRIPTION

Made of PP stabilized against UV rays. Assembled by fitting the modules together.

	Code	Standard Pack	Standard weight in kg	Standard volume in m ³
Modular grating for curves				
Height 22 mm, width 195 mm	11107	470	15.8	0.080
Height 22 mm, width 245 mm	11108	320	13.6	0.080
Height 22 mm, width 295 mm	19202	300	18.0	0.080
Height 22 mm, width 335 mm	19203	250	17.0	0.080
Reversible modular grating for curves				
Height 35 mm, width 195 mm	00220	450	16.5	0.080
Height 35 mm, width 245 mm	00221	300	14.3	0.080
Height 35 mm, width 295 mm	00222	290	19.3	0.080
Height 35 mm, width 335 mm	00223	250	18.1	0.080

Modular grating for curves

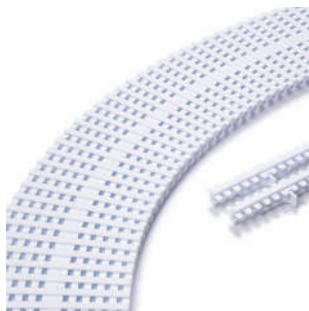

DESCRIPTION

Made of PP stabilized against UV rays. Assembled by fitting the modules together. Non-slip surface. Other colours available on request. For further information, please contact your AstralPool dealer. Compliant with standard EN-13451-1 (8 mm). Class 3 slip resistance (Rd>45) pursuant to UNE-ENV 12633: 2003.

	Code	Standard Pack	Standard weight in kg	Standard volume in m ³
Modular grating for curves				
Height 22 mm, width 195 mm	28656	470	20.84	0.082
Height 22 mm, width 245 mm	28657	320	18.80	0.082
Height 22 mm, width 295 mm	28658*	300	18.80	0.082
Height 22 mm, width 335 mm	28659*	250	20.84	0.082
Reversible modular grating for curves				
Height 35 mm, width 195 mm	28660	450	26.90	0.082
Height 35 mm, width 245 mm	28661	300	24.70	0.082
Height 35 mm, width 295 mm	28662*	290	26.61	0.082
Height 35 mm, width 335 mm	28663*	250	22.25	0.082

* In testing process.

Transversal grating

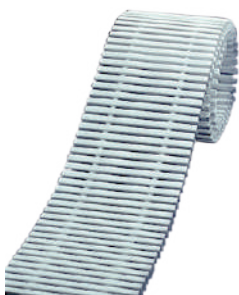

DESCRIPTION

Made of PP stabilized against UV rays. Fastened together by a pass-through cable (49 units per metre).

	Code	Standard Pack	Standard weight in kg	Standard volume in m ³
Height 22 mm, width 195 mm	00212	340	11.9	0.039
Height 22 mm, width 245 mm	00213	305	13.2	0.039



Other grating colours can be made to order. For further information, ask your AstralPool dealer.



GRILLES FOR OVERFLOW

Stainless steel plastic coated cable



DESCRIPTION

Ø 2.5 mm for fastening modules together.

	Code	Standard Pack	Standard weight in kg	Standard volume in m ³
Stainless steel plastic coated cable	00214	1000 m	21.0	0.036

AISI-316L stainless steel plastic coated cable



DESCRIPTION

Ø 2.5 mm for fastening modules together.

	Code	Standard Pack	Standard weight in kg	Standard volume in m ³
AISI-316L stainless steel plastic coated cable	00215	1000 m	21.0	0.036

Cable locking pins



DESCRIPTION

Made of brass.

	Code	Standard Pack	Standard weight in kg	Standard volume in m ³
Cable locking pins	00216	100	1.5	0.001

Transversal grating tile



DESCRIPTION

Made of PP stabilized against UV rays. Tiles fitted together using a snap fastening system (5 units = 0.975 m).

	Code	Standard Pack	Standard weight in kg	Standard volume in m ³
Height 22 mm, width 245 mm	00217	52	22.8	0.080
Height 22 mm, width 295 mm	00218	45	23.1	0.080
Height 22 mm, width 335 mm	00219	38	22.0	0.080

Grating support profile



DESCRIPTION

Suitable for grating heights of 22, 24 and 35 mm. Made of weather resistant plastic. Supplied in 2 m strips.

Inside measurements: 24 mm x 37 mm.

Available in other colours. For further information, ask your dealer.

	Code	Standard Pack	Standard weight in kg	Standard volume in m ³
Grating support profile	00224	25	13.2	0.033

GRILLES FOR OVERFLOW

90° corner tiles for overflow channels



Other grating colours can be made to order. For further information, ask your AstralPool dealer.

DESCRIPTION

Made of white, injection moulded copolymer polypropylene.

	Code	Standard Pack	Standard weight in kg	Standard volume in m ³
Height 22 mm				
Channel width 195 mm	22379	4	2.8	0.006
Channel width 245 mm	22380	4	3.6	0.009
Channel width 295 mm	22381	4	4.8	0.012
Channel width 335 mm	22382	4	5.7	0.016
Height 35 mm				
Channel width 195 mm	22383	4	3.2	0.009
Channel width 245 mm	22384	4	4.1	0.014
Channel width 295 mm	22385	4	5.3	0.012
Channel width 335 mm	22386	4	6.2	0.023



Stainless steel longitudinal grating



DESCRIPTION

Longitudinal grating made of stainless steel. A channel 5 mm wider than the grating must be dug so that it is easy to fit.

It is made up of straight sections of AISI-316L stainless steel, 500 mm in length. Straight sections can be made to measure in order to fit the length of any pool.

There are 4 different models depending on the grating used. Height 35 mm.

	Code	Standard Pack	Standard weight in kg	Standard volume in m ³
Stainless steel longitudinal grating				
195 mm	32415	-	-	-
245 m	32416	-	-	-
295 mm	32417	-	-	-
345 mm	32418	-	-	-

Stainless steel reinforced grating

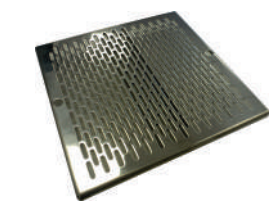

70956

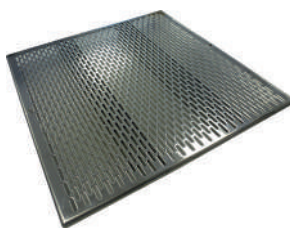

70957

DESCRIPTION

AISI-316L stainless steel grating, compliant with standard EN: 1345-1:2000. Resistant to salt water. Intended for use in both residential and public pools.

	Code	Standard Pack	Standard weight in kg	Standard volume in m ³
Reinforced 252 x 252 mm grating	70956	1	-	-
Reinforced 410 x 410 mm grating	70957	1	-	-





POOL SHELL EQUIPMENT



79	POOL SHELL MATERIAL COLOR RANGE	110	Winter accessories
80	Skimmers 25 L	111	LINER AND PREFABRICATED POOL
80	SKIMMER UNIK	111	15 L Skimmers
81	25 L Skimmers	114	17.5 L Skimmers
82	CONCRETE POOL	119	Skimmer accessories
82	15 L Skimmers	120	17.5 L Stainless Steel Skimmers
83	17.5 L Skimmers	120	Stainless Steel Skimmer accessories
87	Skimmer accessories	121	Main drains
89	Stainless Steel 17.5 L Skimmers	127	Main drains accessories
92	Stainless Steel Skimmer accessories	128	Level regulators
93	Level regulators	129	Inlets
94	Main Drains	137	Stainless Steel Inlets
100	Main Drains accessories	139	Stainless Steel Embellishers for ABS
100	Main drain grilles	140	Wall bushings
103	Inlets	141	Floating skimmer
108	Stainless Steel Inlets	142	Interchangeable accessories
110	Wall bushings	143	INSTALLATION DIAGRAMS

SKIMMER UNIK DESIGNED PERFECTLY. INTEGRATED EVENLY.



FULLY INTEGRATED.

Skimmer Unik blends harmoniously into the surroundings of the pool thanks to its fully integrated top cover. Thanks to its lower height of water level from pool floor -5.5 cm- Skimmer Unik offers an infinite pool effect.



QUIET OPERATION.

Skimmer Unik brings improved silent operation thanks to its exclusive curved floater solution.

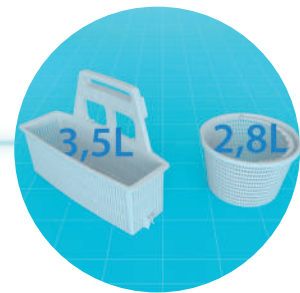

EASY MAINTENANCE.

Skimmer Unik eases the maintenance thanks to its larger basket capacity (3.5L)* and its easy retrieval without touching the water.

*Versus AstralPool traditional skimmer basket.

FILTERING SKIMMER

THE EASY TO INSTALL 2-IN-1 SOLUTION

Easy and fast installation : The installation of this integrated solution (skimmer + cartridge) means that the installer will save a lot of time when building a pool and it significantly reduces labor costs.

Two-in-one skimmer and filter solution :

1. The skimmer drains the water and retains any debris.
2. The water is then filtered by the integrated cartridge of 15 microns that delivers unbeatable filtration quality. Once the water is clean, it is sucked by the pump and sent back to the pool. See our pump recommendations at the bottom of this page.

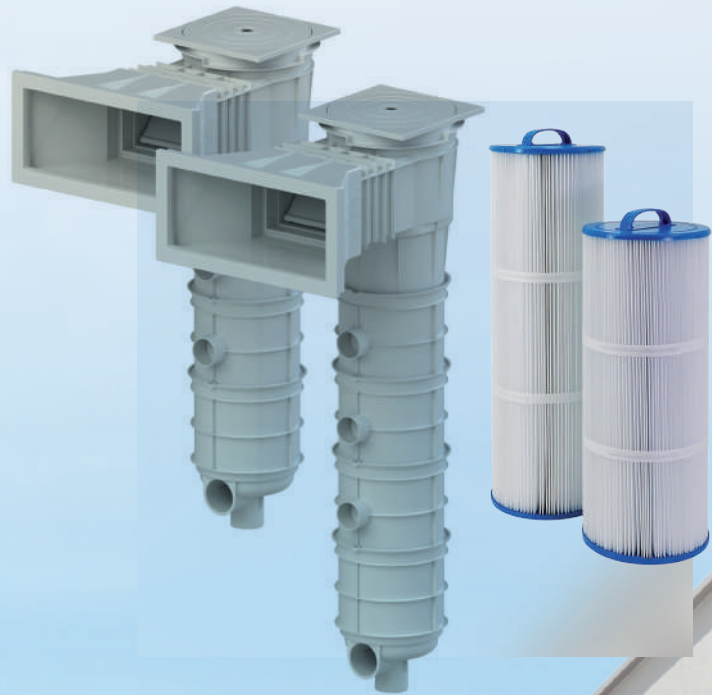

SKIMMER & CARTRIDGE

1. EASYCOLOR SHEATH

→ The color change is proposed with an inlet sheath, both the embellisher and the floater. This sheath could be installed without changing the skimmer mouth what is very practical to renew or upgrade pools.

2. OPTIMUM FILTRATION & EASY TO REPLACE

→ **Optimum filtration quality : 15 microns.**
In addition, the skimmer's cartridges are easy to change.

3. SAFE AND INTEGRATED

→ Possibility to have side suction nozzle inlets, as well as an upper mouth, in order to avoid blockages and ensure that the pump always sucks filtered water.

4. WHICH SKIMMER TO CHOOSE?

CARTRIDGE	16 m ³					
	20 m ³					
Pool volume	30 m ³	40 m ³	50 m ³	60 m ³	70 m ³	80 m ³
ASTRALPOOL PUMP RECOMMENDED	Ref. 25465 Sena 1HP (11.5 m ³ /h @ 10 m.H ₂ O)					
				Ref. 25467 Sena 1.25 HP (14 m ³ /h @ 10 m.H ₂ O)		

STAINLESS STEEL POOL FITTINGS

A FULL RANGE FOR CONSTRUCTION

Using stainless steel in AISI 316-L pools has many advantages in comparison with traditional materials.

- ✓ Better resistance to high and low temperatures, no deformation.
- ✓ Better looking quality finishes.
- ✓ Doesn't age due to exposure to sunlight.
- ✓ Easy to clean.
- ✓ Stainless Steel is environmentally friendly and 100% recyclable.



This is why AstralPool, a world leader in the manufacture and supply of pool materials, is launching a line of embedding products in high quality stainless steel (AISI 316-L), ideal for the construction, refurbishment and upgrade of your pool.



LumiPlus FlexiNiche

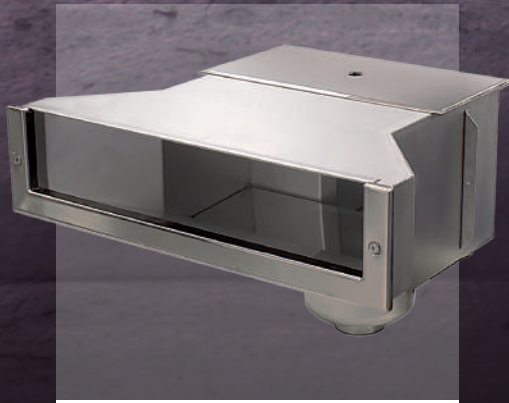

**High Water Level
Skimmer**



**Embellishers to ABS
pool fits**

Color range



Summary of the standard pool fits that exist in color version: Beige, Light Grey, Anthracite grey

Family		Descriptions	Concrete pool	Colors	Page	Liner and Prefabricated pool	Colors	Page	
Skimmer	15L	Skimmer 15L STD - opening	00249CLXXX		82				
		Skimmer 15L - with wide mouth opening	00251CLXXX		82	34413CLXXX		112	
	17.5L	Skimmer Norm - with inserts					56176CLXXX		115
		Skimmer Norm - without inserts	58707CLXXX		83	56299CLXXX		115	
		Skimmer 17.5L - with standard mouth opening, square cover					11309CLXXX		116
		Skimmer 17.5L - with standard mouth opening, 6° for polyester pool, round cover					68108CLXXX		116
		Skimmer 17.5L - with standard opening					11310CLXXX		117
		Skimmer 17.5L with wide mouth opening					11311CLXXX		117
		Skimmer 17.5L with wide mouth opening for parker model					11317CLXXX		117
	25L	Skimmer Unik		Several codes		81	Several codes		81
Main drain		Norm main drain	56378CLXXX		95	56380CLXXX		122	
		Norm main drain - Antivortex grating	56379CLXXX		95	56382CLXXX		122	
		Norm main drain - without inserts				56381CLXXX		122	
		Norm main drain - ithout inserts Antivortex grating				56383CLXXX		122	
		Round main drain 2" outlet				00271CLXXX		124	
		Round main drain 2" outlet - without inserts	01467CLXXX		95	06474CLXXX		124	
	Nozzles	Impulsion	Multiflow return inlet	00295CLXXX		104	00330CLXXX		129
Multiflow return inlet			00298CLXXX		104	00334CLXXX		130	
Multiflow return inlet						17383CLXXX		130	
Norm return inlet						56499CLXXX		129	
Norm return inlet						56500CLXXX		129	
Suction Pool Floor		Suction nozzle	00300CLXXX		106	17382CLXXX		134	
		Suction nozzle 2"				00332CLXXX		133	
		Suction nozzle 2"				00336CLXXX		134	
Pool Floor		Pool floor return inlet	00303CLXXX		105	00340CLXXX		132	
		Pool floor return inlet with swivel joint	22353CLXXX		105			105	
Lateral nozzle	Lateral nozzle polyester pool				74121CLXXX		134		
Hydromassage kits		Length wall conduit 190 mm	32113CLXXX		107	31443CLXXX ⁽¹⁾		107	
		length wall conduit 280 / 275 mm	32370CLXXX		107	32371CLXXX ⁽¹⁾		107	
		Length wall conduit 190 mm				32114CLXXX ⁽²⁾ 32115CLXXX ⁽³⁾		134	
		Length wall conduit 275 mm				32384CLXXX ⁽²⁾ 32385CLXXX ⁽³⁾		134	
	Net & clean	Nozzles				65234CLXXX*		361	
Lighting	LumiPlus Flexi	Decorative ring FlexiNiche	71209CLXXX				416		
		Decorative ring FlexiSlim	71210CLXXX				416		
		Decorative ring FlexiRapid	71211CLXXX				416		
	LumiPlus FlexiMini	Decorative ring for Niches	74392CLXXX				419		
		Decorative ring for Nozzles L	74393CLXXX				419		
		Decorative ring for Nozzles S	74394CLXXX				419		
		Decorative ring for Pipes	74395CLXXX				419		

* Only for concrete and prefabricated pools.

- (1) Concrete with liner
- (2) pref. with polyester
- (3) pref. with liner

Skimmers 25 L



Répond aux normes
EN 16582-1
EN 16713-2



Skimmer Unik

DESIGNED PERFECTLY. INTEGRATED EVENLY

- + Fully integrated.
- + Quiet operation.
- + Easy maintenance.

SELECTION TABLE

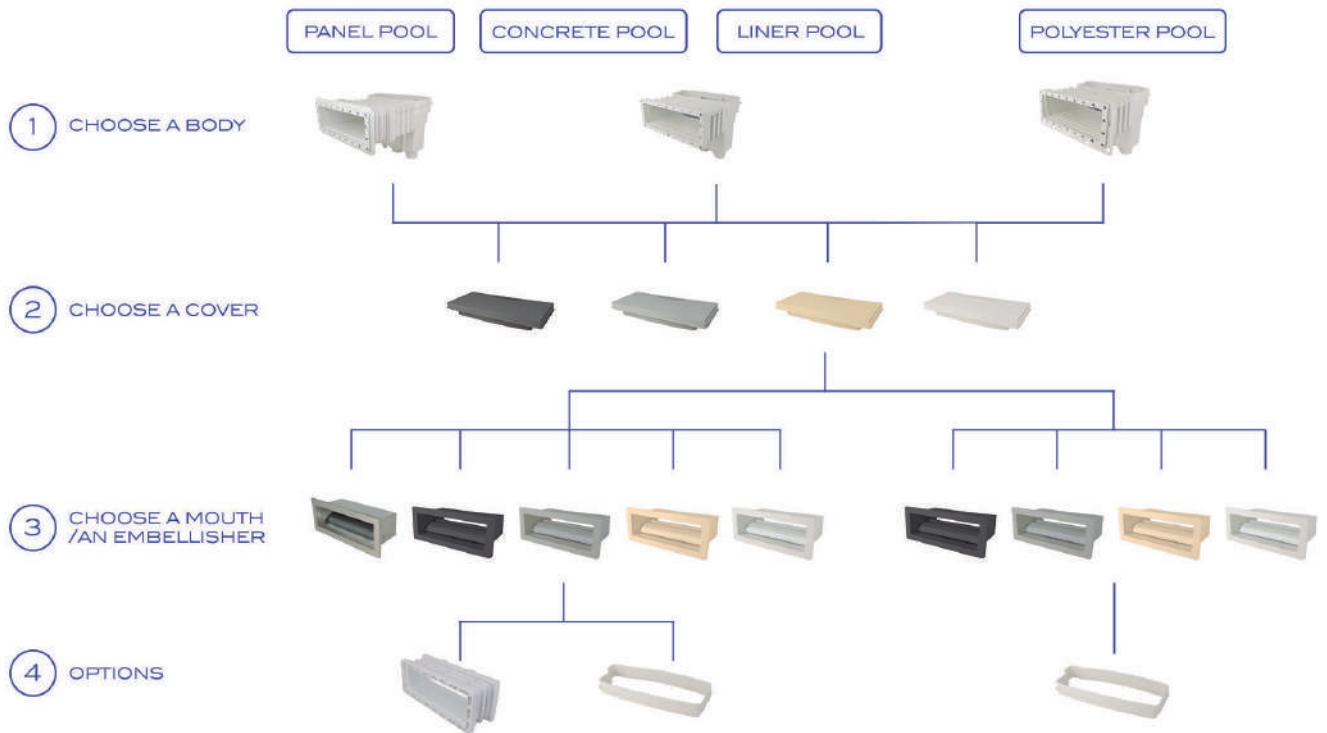

INSTALLATION

How to install skimmer mouth?



How to integrate cover in the pool surround material?



How to assemble skimmer UNIK?



How to glue panels version?



DIMENSIONS OF THE KITS

74457 - 74458 - 74459 - 74460

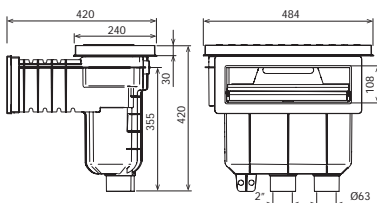

74461 - 74462

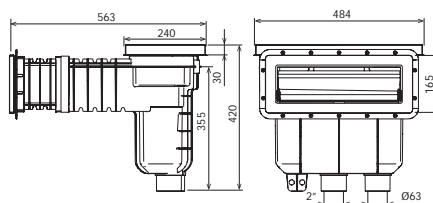

74463 - 74464

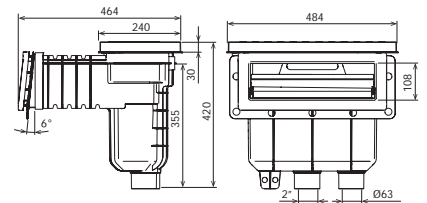

25 L Skimmers

Skimmer Unik

components to install a Skimmer Unik



Complies with Standards
EN 16582-1
EN 16713-2

The skimmer Unik is a solution that allows maximum flexibility in terms of colors of the visible parts.
Choose amongst the components according to your requirements.

1	Skimmer body - ABS white color		Code
	Skimmer body CONCRETE POOL WITHOUT INSERTS		74830
	Skimmer body CONCRETE POOL WITH INSERTS		74831
	Skimmer body LINER POOL WITHOUT INSERTS*		74832
	Skimmer body LINER POOL WITH INSERTS*		74833
	Skimmer body PANEL POOL WITHOUT INSERTS		74834
	Skimmer body PANEL POOL WITH INSERTS		74835
	Skimmer body POLYESTER POOL 6° WITHOUT INSERTS		74836
	Skimmer body POLYESTER POOL 6° WITH INSERTS		74837

* Delivered with 2 sets of screws DIN 7982 A4 5.5x25 and 32

2	Skimmer covers - ABS		Code
	Skimmer cover WHITE		74838
	Skimmer cover BEIGE		74838CL090
	Skimmer cover GREY		74838CL129
	Skimmer cover ANTHRACITE		74838CL144

3	Skimmer mouth / embellisher		Code
	3.1 - FOR CONCRETE LINER AND PANEL POOLS		
	Standard ABS WHITE		74839
	Standard ABS BEIGE		74839CL090
	Standard ABS GREY		74839CL129
	Standard ABS ANTHRACITE		74839CL144
	Standard STAINLESS STEEL A316-L		74806
	3.2 - FOR POLYESTER POOLS		
	6° Mouth - WHITE		74840
	6° Mouth - BEIGE		74840CL090
	6° Mouth - GREY		74840CL129
6° Mouth - ANTHRACITE		74840CL144	

Kit Skimmer UNIK ABS color white: Body + Cover + Embellisher		Code
	Skimmer UNIK CONCRETE POOL WITHOUT INSERTS	74457
	Skimmer UNIK CONCRETE POOL WITH INSERTS	74458
	Skimmer UNIK LINER POOL WITHOUT INSERTS	74459
	Skimmer UNIK LINER POOL WITH INSERTS	74460
	Skimmer UNIK PANEL POOL WITHOUT INSERTS	74461
	Skimmer UNIK PANEL POOL WITH INSERTS	74462
	Skimmer UNIK POLYESTER POOL 6° WITHOUT INSERTS	74463
	Skimmer UNIK POLYESTER POOL 6° WITH INSERTS	74464

Skimmer Options - valid for the skimmers parts sold separately or the full sets		Code
	EXTENDED Mouth Standard WITHOUT INSERTS	74841
	EXTENDED Mouth Standard WITH INSERTS	74842
	EXTENDED Mouth POLYESTER POOL 6° WITHOUT INSERTS	74843
	EXTENDED Mouth POLYESTER POOL 6° WITH INSERTS	74844
	COVER EXTENSION RING	74845

Concrete pool - 15 L Skimmers

- All of the components that are exposed in this range of skimmers come with a UV treatment. Made of ABS, they come with a weir flap and a flow regulator check valve. Bottom suction nozzle connection: 1½" inner thread, 2" outer thread.
- Simultaneous connection to the main drain: Ø 50 mm inner wall. Overflow connection: Ø 40 mm. Leaf trap. Recommended flow rate: 5 m²/h.
- It is recommended that one skimmer be installed for every 25 m² of water surface area.



Complies with Standards
EN 16582-1
EN 16713-2

Skimmer with standard mouth opening



	Code	Standard Pack	Standard weight in kg	Standard volume in m ³
With round lid - White	00249	1	2.95	0.059
With round lid - Beige	00249CL090	1	2.95	0.059
With round lid - Light grey	00249CL129	1	2.95	0.059
With round lid - Anthracite grey	00249CL144	1	2.95	0.059
With square lid	00250	1	3.15	0.059

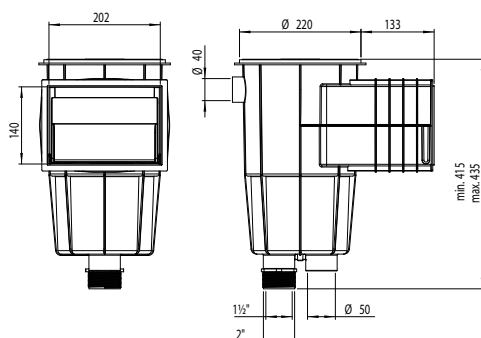

Skimmer with wide mouth opening



Complies with Standards
EN 16582-1
EN 16713-2

	Code	Standard Pack	Standard weight in kg	Standard volume in m ³
With round lid - White	00251	1	4.47	0.12
With round lid - Beige	00251CL090	1	4.47	0.12
With round lid - Light grey	00251CL129	1	4.47	0.12
With round lid - Anthracite grey	00251CL144	1	4.47	0.12
With square lid	00252	1	3.00	0.12

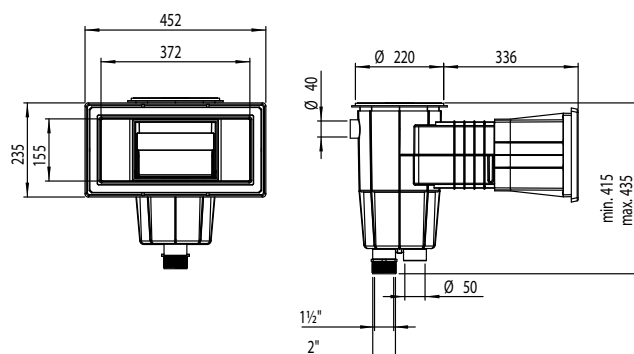

Concrete pool - 17.5 L Skimmers

- All of the components that are exposed in this range of skimmers come with a UV treatment. Made of ABS, they come with a weir flap and a flow regulator check valve. Bottom suction nozzle connection: 1½" inner thread.
- Simultaneous connection to the main drain: 2" inner thread. Overflow connection: Ø 32 mm. Round cover with spring clip fastening system.
- The height of the cover can be adjusted and turned through an extended throat, so that it sits perfectly flush with the coping stone.
- Leaf trap secured to base by means of a bayonet mount. In-built weir flap housing. Recommended flow rate: 7.5 m³/h.
- It is recommended that one skimmer be installed for every 25 m² of water surface area.

NORM skimmer



58707



58707CL090



58707CL129



58707CL144



Complies with Standards
EN 16582-1
EN 16713-2

DESCRIPTION

17L skimmer range suitable for installation in public and private pools. Manufactured in ABS with UV treatment, it comes with a weir flap, flow regulator, lid height adjustment and basket. The water inlet is 495 x 80 mm. Recommended flow rate of 7.5 m³/h. Install one skimmer every 25 m² of water line surface area. Connections under 1½" and 2", water overflow connection of Ø 40 mm.

	Code	Standard Pack	Standard weight in kg	Standard volume in m³
NORM 17,5L skimmer				
White	58707	1	5.61	0.182
Beige	58707CL090	1	5.61	0.182
Light grey	58707CL129	1	5.61	0.182
Anthracite grey	58707CL144	1	5.61	0.182

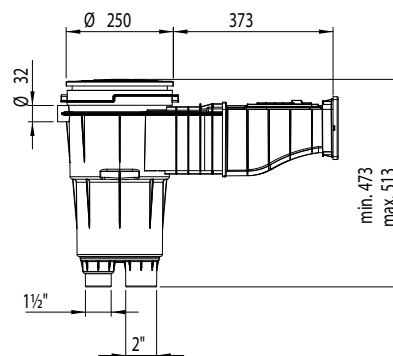
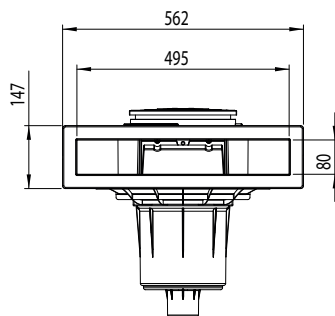

Concrete pool - 17.5 L Skimmers

Skimmer with standard mouth opening



Complies with Standards
EN 16582-1
EN 16713-2

	Code	Standard Pack	Standard weight in kg	Standard volume in m ³
With square lid	11306	1	4.20	0.062

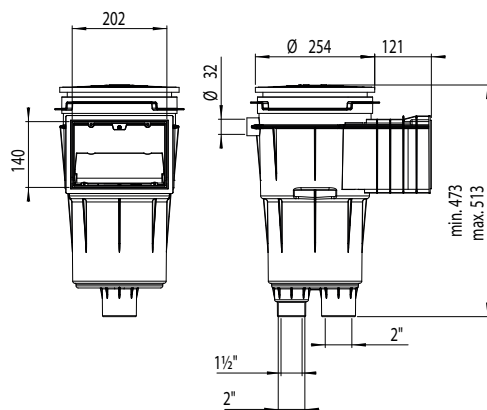

Filtering Skimmer



73158

73161

DESCRIPTION

17.5 L skimmer with cartridge system integrated. Made of ABS with UV treatment. Incorporate gate, regulator lid height, skimmer basket and 2 cartridge filters. Upper access water connection Ø 32 mm, bottom connections of Ø 63 mm and lateral of Ø 50 mm. Lateral connections are for connecting suction nozzles.

The color change is proposed with an inlet sheath, both the embellisher and the floater. This sheath could be installed without changing the skimmer mouth what is very practical to renew or upgrade pools.

	Code	Standard Pack	Standard weight in kg	Standard volume in m ³
Filtering skimmer - white				
Filtering skimmer with 2 cartridges 16 m ³	73158	1	12	0.32
Filtering skimmer with 2 cartridges 20 m ³	73161	1	13	0.32
EASYCOLOR - Inlet sheath*				
Light grey - inlet sheath	73166CL129	1	1.22	0.02
Anthracite - inlet sheath	73166CL144	1	1.22	0.02
Beige - inlet sheath	73166CL090	1	1.22	0.02
Cartridge				
Cartridge* 16 m ³ /h - 15 microns	73164	1	1.64	0.02
Cartridge* 20 m ³ /h - 15 microns	73165	1	2.24	0.026



73166CL129



73166CL144



73166CL090

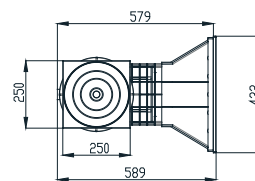
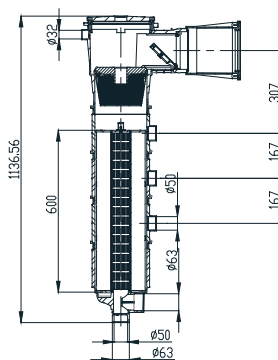
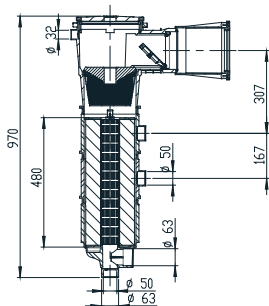

Complies with Standards
EN 16713-1



Complies with Standards
EN 16582-1
EN 16713-2

*2-year limited warranty - please refer to the instruction manual

Concrete pool - 17.5 L Skimmers

Skimmer with standard opening and face plate



	Code	Standard Pack	Standard weight in kg	Standard volume in m ³
With square lid	11302	1	5.20	0.062

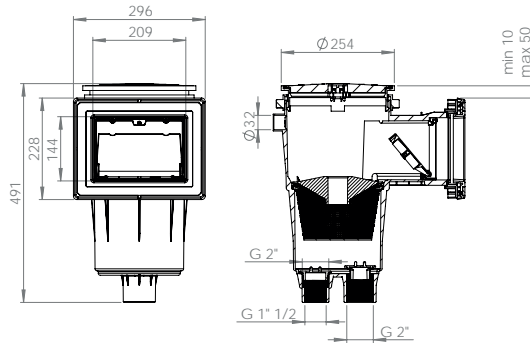

Skimmer with standard opening and extended throat



	Code	Standard Pack	Standard weight in kg	Standard volume in m ³
With square lid	11307	1	5.90	0.077

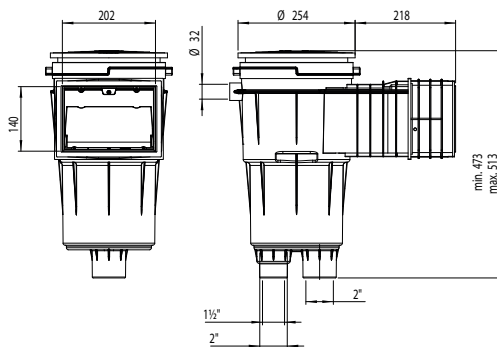

Skimmer with standard opening, extended throat and face plate



	Code	Standard Pack	Standard weight in kg	Standard volume in m ³
With square lid	11303	1	5.75	0.060

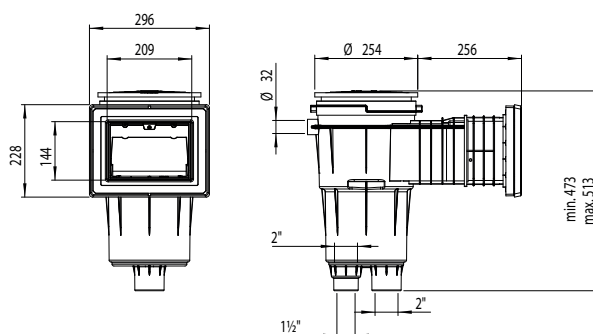

Concrete pool - 17.5 L Skimmers



Skimmer with wide mouth opening



Complies with Standards
EN 16582-1
EN 16713-2

	Code	Standard Pack	Standard weight in kg	Standard volume in m ³
With square lid	11304	1	6.24	0.135

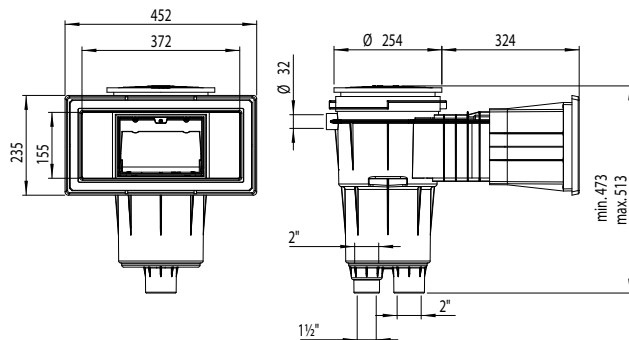

Complies with Standards
EN 16582-1
EN 16713-2

Skimmer with extended throat and wide opening



	Code	Standard Pack	Standard weight in kg	Standard volume in m ³
With square lid	11305	1	6.90	0.161

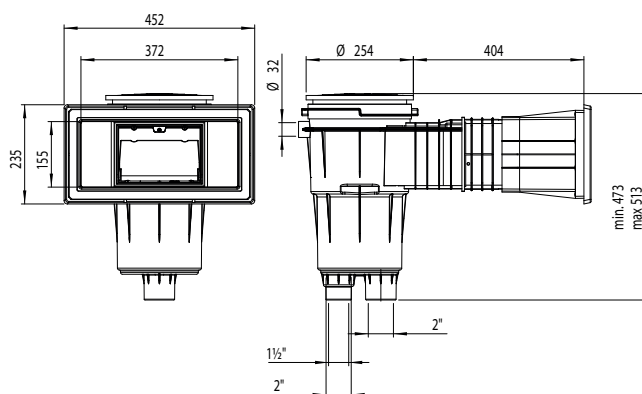

Concrete pool - Skimmer accessories

Covers for 15 l skimmers

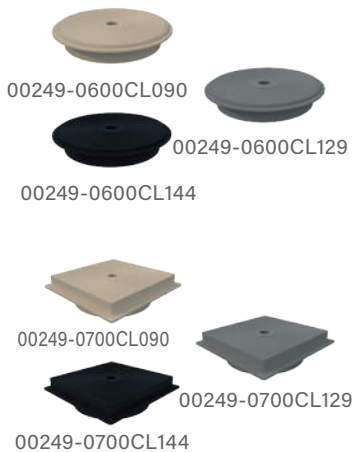

	Code	Standard Pack	Standard weight in kg	Standard volume in m ³
Round cover, round face plate				
Beige	00249-0600CL090	23	7.9	0.069
Light grey	00249-0600CL129	23	7.9	0.069
Anthracite grey	00249-0600CL144	23	7.9	0.069
Round cover, square face plate				
Beige	00249-0700CL090*	13	6.9	0.069
Light grey	00249-0700CL129*	13	6.9	0.069
Anthracite grey	00249-0700CL144*	13	6.9	0.069

* Compatibles with level regulator 15862 for a color customization of the level regulator.

Covers for 17.5 l skimmers



	Code	Standard Pack	Standard weight in kg	Standard volume in m ³
Round cover, round face plate				
Beige	05280-0600CL090	15	8	0.069
Light grey	05280-0600CL129	15	8	0.069
Anthracite grey	05280-0600CL144	15	8	0.069
Round cover, square face plate				
Beige	05280-0700CL090	15	8	0.069
Light grey	05280-0700CL129	15	8	0.069
Anthracite grey	05280-0700CL144	15	8	0.069

EASYCOLOR - Inlet Sheath

for wide mouth skimmers



DESCRIPTION

The EASYCOLOR inlet sheath kit allows to change the color of the skimmers wide mouth items 00251, 00252, 11304 and 11305, both the embellisher and the floater. This sheath could be installed without change the skimmer mouth what is very practical to renew or upgrade pools. This kit includes inlet sheath, floater, flanges and embellisher.

	Code	Standard Pack	Standard weight in kg	Standard volume in m ³
Beige - inlet sheath	74035CL090	1	1.22	0.022
Light grey - inlet sheath	74035CL129	1	1.22	0.022
Anthracite grey - inlet sheath	74035CL144	1	1.22	0.022

Concrete pool - Skimmer accessories



15 l skimmer cover extension ring



DESCRIPTION

Additional extension ring to increase the distance between the 15 l skimmer and the lid. Additional distance of 25 mm. Made of ABS. The height can be increased by overlaying various connections. It can also be slightly tipped to be level with the ground.

	Code	Standard Pack	Standard weight in kg	Standard volume in m ³
	19919	17	4.08	0.069



17.5 l skimmer cover extension ring



DESCRIPTION

Additional ring for better adjusting and levelling the 17.5 l skimmer lid to the deck level. Additional distance of 20 mm. Made of white ABS. The height can be increased by overlaying various connections. It can also be slightly tipped to be level with the ground.

	Code	Standard Pack	Standard weight in kg	Standard volume in m ³
	18153	17	4.70	0.06



Floating weir assembly in ABS



DESCRIPTION

Complete with strainer basket in white ABS.

	Code	Standard Pack	Standard weight in kg	Standard volume in m ³
For 15 l skimmers	00253	12	20.5	0.207
For 17.5 l skimmers	05703	12	20.5	0.207



Prefilters for skimmer basket



DESCRIPTION

Hygienic disposable prefilters for any type of skimmer (with baskets up to Ø 24 cm). They retain the waste that builds up in the skimmer basket. This protects the pump and the filter therefore performs better.

	Code	Standard Pack	Standard weight in kg	Standard volume in m ³
12 units per box	042745	12	0.40	0.006

Concrete pool - S.S. 17.5 L Skimmers

SLIM: High water level skimmer



DESCRIPTION

High water level skimmer allows high water level in the pool (+/- 4 cm) giving an infinite pool effect. The water line is located very close to the top of the pool. Entirely made of AISI-316L. All models are equipped with Ø50 mm overflow and have a housing to mount a water level regulator - item 73453 - not included. Also compatible with the most standard water levels of the market. With connection for equipotential connection. It also includes flanges for prefabricated pools. Recommended flow 7.5 m³/h. Basket capacity 1.2 L.

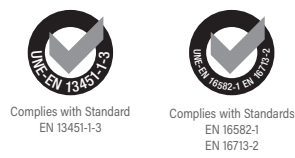

Complies with Standard EN 13451-1-3

Complies with Standards EN 16582-1 EN 16713-2



	Code	Standard Pack	Standard weight in kg	Standard volume in m ³
Mouth width 500 mm	73501	1	14.80	0.136
Mouth width 650 mm	73502	1	15.20	0.169

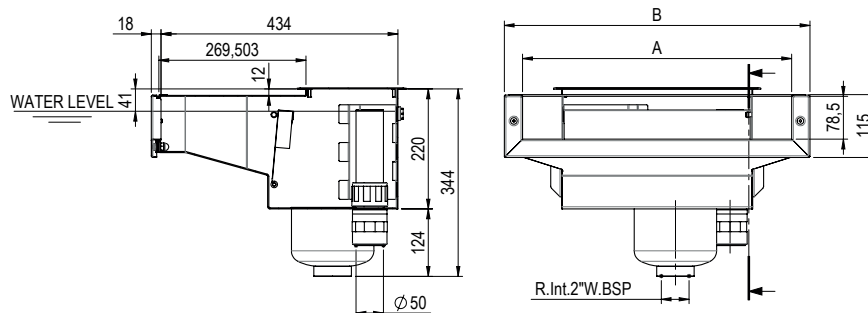

SLIM: S.S. Skimmer A-500 & A-650

Large mouth

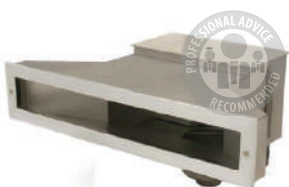

DESCRIPTION

In AISI-316L stainless steel. With Ø50mm overflow, basket and lid in stainless steel, both included. It has accommodation to mount the level regulator valve 73453 (see page 93). With connection for equipotential connection. Flow recommended 7.5 m³ / h. Items 56313 and 56316 includes flanges for prefabricated pools. Also exist with 6° inclination: items 72744 and 72743 see page 120. Water level +/- 8 cm. Basket capacity 1.2L.

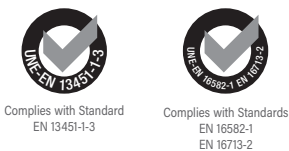

Complies with Standard EN 13451-1-3

Complies with Standards EN 16582-1 EN 16713-2



	Code	Standard Pack	Standard weight in kg	Standard volume in m ³
Mouth width 500 mm	56313	1	14.84	0.136
Mouth width 650 mm	56316	1	14.84	0.136

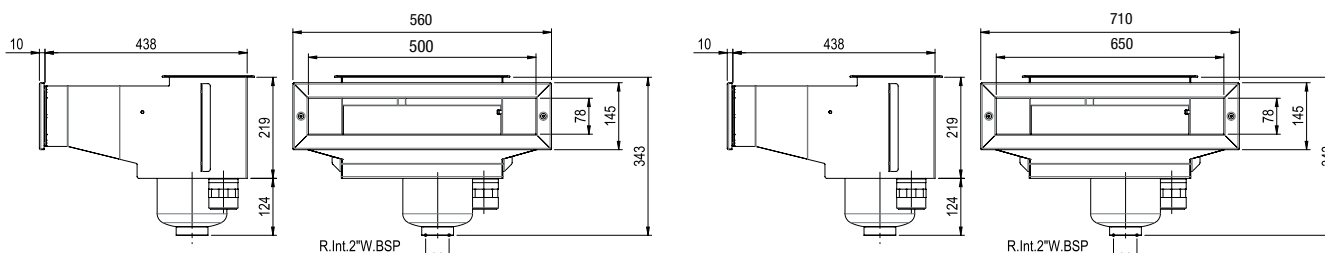

Concrete pool - S.S. 17.5 L Skimmers



Full A-100 Skimmer S.S.



DESCRIPTION

In AISI-316L stainless steel. With Ø 50mm overflow. Stainless Steel basket and lid included. Basket capacity 1.2 L. Comes with housing for assembling the 00256 level regulator valve (see page 93). With connection for an equipotential outlet. Recommended flow rate: 7.5 m³/h. Does not include trim code 00255. For liner, prefabricated and panel pools use coupling kit 07525 not included.



Complies with Standards
EN 16582-1
EN 16713-2

	Code	Standard Pack	Standard weight in kg	Standard volume in m ³
Suction connection, 2" thread	00254	1	8.4	0.04

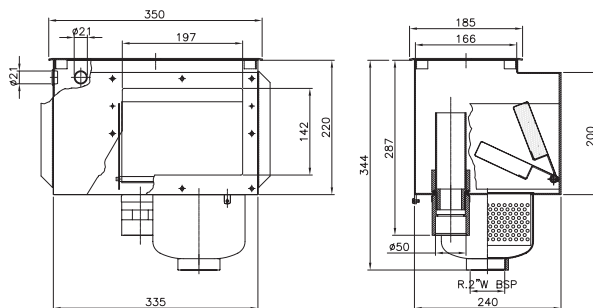

Decorative face plate



DESCRIPTION

For skimmer 00254. Made of AISI-316L stainless steel.



Complies with Standards
EN 16582-1
EN 16713-2

	Code	Standard Pack	Standard weight in kg	Standard volume in m ³
	00255	1	0.62	0.003

A-201 skimmer body



DESCRIPTION

In AISI-316L stainless steel. With Ø 50mm overflow. Skimmer housing without telescopic lid. Comes with housing for assembling the 00256 level regulator valve (see page 93). With connection for an equipotential outlet. Basket can be removed from front. Does not include trim code 07251. Ø 63 mm suction connection. For liner, prefabricated and panel pools use coupling kit 07525 not included.



Complies with Standards
EN 16582-1
EN 16713-2

	Code	Standard Pack	Standard weight in kg	Standard volume in m ³
	07520	1	6.51	0.04

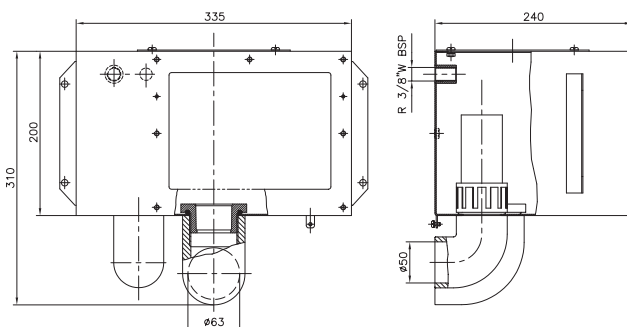

Concrete pool - S.S. 17.5 L Skimmers

A-202 skimmer body

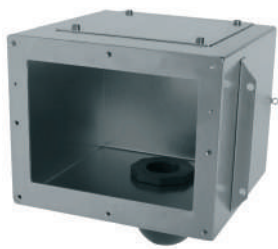

DESCRIPTION

In AISI-316L stainless steel. With Ø 50 mm overflow. Skimmer housing without telescopic lid. With earth connection. Basket can be removed from front. Does not include trim code 07251. For liner, prefabricated and panel pools use coupling kit 07525 not included.

	Code	Standard Pack	Standard weight in kg	Standard volume in m ³
Ø 63 mm suction connection	07610	1	5.25	0.04

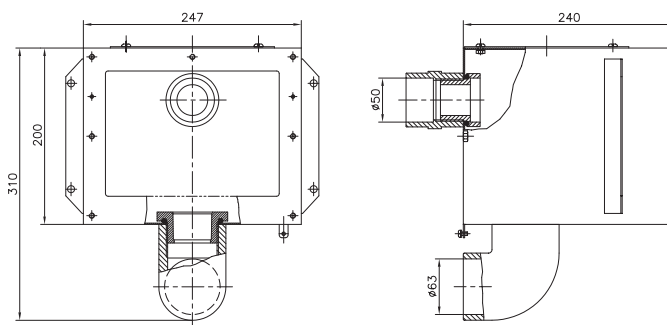

Complies with Standards
EN 16582-1
EN 16713-2



Basket for A-201 and A-202 skimmers



DESCRIPTION

Basket in AISI-316L stainless steel. Includes face plate for direct removal through skimmer opening. Basket capacity 4.6L.

	Code	Standard Pack	Standard weight in kg	Standard volume in m ³
	07521	1	2.19	0.02



Complies with Standards
EN 16582-1
EN 16713-2



A-400 skimmer body



DESCRIPTION

In AISI-316L stainless steel. With Ø 50mm overflow. Skimmer housing without telescopic lid. Comes with housing for assembling the 00256 level regulator valve (see page 93). With connection for an equipotential outlet. For liner, prefabricated and panel pools use coupling kit 07526 not included.

	Code	Standard Pack	Standard weight in kg	Standard volume in m ³
Ø 63 mm suction connection	07523	1	8.0	0.06

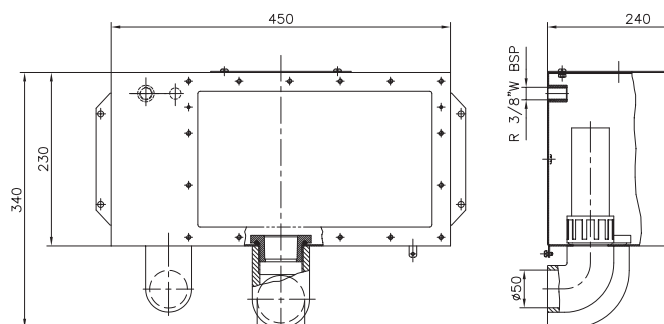

Complies with Standards
EN 16582-1
EN 16713-2

Concrete pool - S.S. 17.5 L Skimmers



Basket for A-400 skimmer



DESCRIPTION

Direct removal through skimmer throat. Wide model. In AISI-316L stainless steel. Basket capacity 11L.



Complies with Standards
EN 16582-1
EN 16713-2

Code	Standard Pack	Standard weight in kg	Standard volume in m ³
07522	1	3.5	0.04

Concrete pool - S.S. Skimmer accessories



Telescopic lid



DESCRIPTION

In AISI-316L stainless steel. For models A-201, A-202 and A-400. 180 x 180 mm lid. Adjustable height from 60 to 110 mm.



Complies with Standard
EN 13451-1-3



Complies with Standards
EN 16582-1
EN 16713-2

Code	Standard Pack	Standard weight in kg	Standard volume in m ³
07524	1	1.63	0.01

Concrete pool - Level regulators

Water level regulator valve



DESCRIPTION

Can be fitted to all stainless steel skimmers, except for model A-202, 56313-56316-72743-72744-73501-73502. Adjustable opening. 3/8" connection.

Code	Standard Pack	Standard weight in kg	Standard volume in m ³
00256	1	0.21	0.002



Universal level regulator



DESCRIPTION

Made of ABS. May be connected from the bottom or side, as required. Semi-die cut outlets to the pool so that the most suitable connection can be made. Adjustable lid height and level. For all types of skimmers. Cover color can be changed using the 15L skimmers covers: 00249-0700CL090, 00249-0700CL129, 00249-0700CL144 from page 87.

Code	Standard Pack	Standard weight in kg	Standard volume in m ³
15862	1	2.0	0.016



Level regulating valve



DESCRIPTION

Level regulator valve compatible with the stainless steel skimmers of SLIM range. Compatible with items: 56313, 56316, 72743, 72744, 73501 73502. With 3/8" side connection and adjustable floater.

Code	Standard Pack	Standard weight in kg	Standard volume in m ³
73453	1	0.9	0.008

Concrete pool - Main drains

Pool main drains information

How affects EN 16713-02 : 2016 main drains in residential pools

	NEW POOL	POOL RENOVATION
--	----------	-----------------

Suction rate: insure a maximum of 0.5 m/s

	ANTI-VORTEX COVER	NON ANTI-VORTEX COVER	WITH MAIN DRAIN BODY CHANGE	UNCHANGED MAIN DRAIN BODY
RISK OF ENTRAPMENT How to prevent it?	Number of main drains per pool: 1	Number of main drains per pool: 2 balanced main drains, distanced at minimum 1 meter. And if any of the 2 main drain is blocked the remaining one should be able to absorb 100% of the installation flow.	Applies new pool rules	Install an anti-vortex grille on pre-installed main drain

CAVITY DIMENSION Main drain should respect a certain cavity dimensions according to a mathematical rule.

OTHERS Other requisites are considered to define that a main drain in compliant with EN, like design. e.g. the design of the grill to avoid human body parts or hair entrapment.

Only with the fulfillment of all requisites of the standard, a Compliance Certification can be delivered!

*Anti-vortex plate is a special component installed in the suction line to control the turbulence in a flowing fluid. These plates allows to control the velocity of the fluid thus preventing cavitation in the fluid.

Concrete pool - Main drains

- All main drains in the range are supplied with UV protection.
- To prevent the risk of suction, install the main drains according to local regulations.
- Recommended use: Maximum suction rate of 0.5 m/s.

NORM main drain



DESCRIPTION

Range of main drains suitable for public and private swimming pools. Supplied with flat or antivortex grilles. Manufactured in ABS with UV treatment, fitted with a 2" side outlet and a 1½" bottom outlet connection, bottom outlet covered by semi-die cut tab.



	Code	Standard Pack	Standard weight in kg	Standard volume in m³
Flat grating - White	56378	4	10.60	0.069
Flat grating - Beige	56378CL090	4	10.60	0.069
Flat grating - Light Grey	56378CL129	4	10.60	0.069
Flat grating - Anthracite Grey	56378CL144	4	10.60	0.069
Antivortex grating - White	56379	4	10.60	0.069
Antivortex grating - Beige	56379CL090	4	10.60	0.069
Antivortex grating - Light Grey	56379CL129	4	10.60	0.069
Antivortex grating - Anthracite Grey	56379CL144	4	10.60	0.069

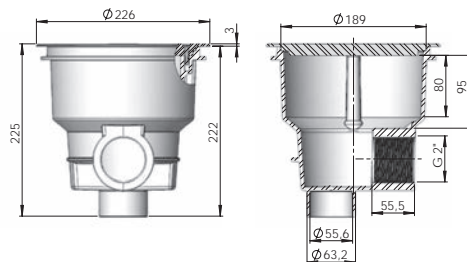

Also available in other colours



Complies with Standards
EN 16582-1
EN 16713-2



Round Ø 270 mm main drain with ABS grating



DESCRIPTION

Bottom 1½" and side 2" outlets. Fully manufactured in white ABS. Side outlet for plug to test watertightness. Bottom outlet with plug and possibility of fitting a hydrostatic valve code 00277 (see page 100) and drainage tube code 21581, (see page 100). Ø 250mm suction grille. Max. flow rate: 13 m³/h.



Complies with Standards
EN 16582-1

	Code	Standard Pack	Standard weight in kg	Standard volume in m³
Standard thread	01466	4	5.0	0.045

Round main drains 2" outlet



DESCRIPTION

Body and grill in ABS. Grill fitted using screws. Max. flow rate: 13 m³/h.



	Code	Standard Pack	Standard weight in kg	Standard volume in m³
Standard thread - White	01467	4	2.8	0.028
Standard thread - Beige	01467CL090	4	2.8	0.028
Standard thread - Light Grey	01467CL129	4	2.8	0.028
Standard thread - Anthracite Grey	01467CL144	4	2.8	0.028



Complies with Standards
EN 16582-1

Concrete pool - Main drains

Round Ø 200 mm main drain

with antivortex grille



Complies with Standards
EN 16582-1

DESCRIPTION

Manufactured in white ABS material. 2" side outlet and 1½" bottom outlet. Bottom outlet covered by semi-die cut socket, which can be opened as required. Possibility of fitting drainage tube code 21581 (see page 100). Max. flow rate: 13 m³/h.

	Code	Standard Pack	Standard weight in kg	Standard volume in m³
Standard thread	27837	4	2.807	0.033

Round Ø 200 mm main drain

with flat grille



Complies with Standards
EN 16582-1

DESCRIPTION

Made of white ABS. 2" side outlet and 1½" bottom outlet. Bottom outlet covered by semi-die cut socket, which can be opened as required. Max. flow rate: 13 m³/h.

	Code	Standard Pack	Standard weight in kg	Standard volume in m³
Standard thread	27839	4	2.807	0.033

Main drain

with square ABS grille (210 mm x 210 mm)



Complies with Standards
EN 16582-1

DESCRIPTION

2" side outlet. Body and grille in white ABS. Grille fitted using screws. Max. flow rate: 13 m³/h.

	Code	Standard Pack	Standard weight in kg	Standard volume in m³
	00258	4	4.0	0.044

Main drain grille

for pool standard compliance



74097

74097CL090



74097CL129

74097CL144



Complies with Standards
EN 16582-1



Complies with Apt.4.4.1 b.2
of EN 16713-2:2017

DESCRIPTION

Grille to replace the grilles on already installed main drains in private pools, to meet pool regulations. Made of PP plastic. Compatible with main drains 01467, 27837, 27839.

	Code	Standard Pack	Standard weight in kg	Standard volume in m³
Grille				
White	74097	6	3	0.033
Beige	74097CL090	6	3	0.033
Light grey	74097CL129	6	3	0.033
Anthracite grey	74097CL144	6	3	0.033

Concrete pool - Main drains

Round main drain

in stainless steel. 2" outlet



00268



26196



Complies with Standards
UNE-EN 16582-1
UNE-EN-16713-2

DESCRIPTION

2" side outlet. Made of stainless steel. AISI-316L. Grille fitted using screws. Maximum flow rate: 13 m³/h.

	Code	Standard Pack	Standard weight in kg	Standard volume in m ³
2" side outlet"	00268	1	2.56	0.02
2" side outlet and 1/2" bottom outlet connection	26196	1	2.80	0.02

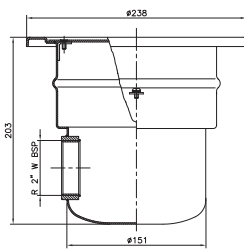

Grille for S.S. main drains

for pool standard compliance



Complies with Standards
UNE-EN 16582-1
UNE-EN-16713-2

DESCRIPTION

Grille to replace the grilles on already installed main drains in private pools, to meet pool regulations. Made of SS AISI-316L. Compatible with main drains 00268, 26196.

	Code	Standard Pack	Standard weight in kg	Standard volume in m ³
Antivortex main drain grille	74807	1	-	-

Main drain with square cover

in stainless steel. Outlet 1 1/2"



Complies with Standards
EN 16582-1
EN-16713-2

DESCRIPTION

Bottom outlet 1 1/2". Manufactured in stainless steel. AISI-316L Antivortex lid. Can be used in concrete and prefabricated pools with an 00276 adapter. Maximum flow rate: 6 m³/h.

	Code	Standard Pack	Standard weight in kg	Standard volume in m ³
Bottom 1 1/2" outlet	08463	1	1.14	0.01

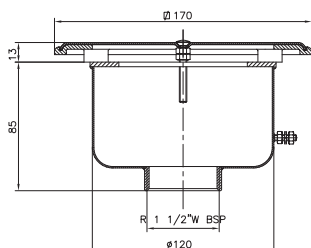

Concrete pool - Main drains

Main drain with square cover

in stainless steel. 2" outlet



DESCRIPTION

2" side outlet. Manufactured in stainless steel. AISI-316L. Antivortex lid. Can be used in concrete and prefabricated pools with a 00276 adapter (see page 125). Maximum flow rate: 6 m³/h.

	Code	Standard Pack	Standard weight in kg	Standard volume in m ³
	00269	1	1.14	0.01



NORM main drain

in polyester and fibreglass - 330 mm x 330 mm



DESCRIPTION

Range of main drains manufactured in polyester resin and fibreglass. Grille in stainless steel AISI-316L. Optional hydrostatic valve. Minimum depth of installation: 1.5 m. Maximum recommended flow rate down drain: 103 m³/h (0.5 m/s).

	Code	Standard Pack	Standard weight in kg	Standard volume in m ³	
Grille in stainless steel AISI-316L.					
Outlet connection					
Flow rate					
to be glued					
Ø 75 mm	15 m ³ /h	20282N	1	8	0.08
Ø 90 mm	23 m ³ /h	20283N	1	9	0.08
Ø 110 mm	27 m ³ /h	20284N	1	10	0.08



Complies with Standard EN 13451-1/3 2012
Complies with Standards EN 16713-02 2016

Main drain

in polyester and fibreglass - 330 mm x 330 mm



DESCRIPTION

With a gelcoat finish. With optional hydrostatic valve. Maximum recommended flow rate in accordance with standard EN 13451-1.

	Code	Standard Pack	Standard weight in kg	Standard volume in m ³	
Grille in stainless steel AISI-316L. Holes < 8 mm					
Outlet connection					
Flow rate					
to be glued					
Ø 75 mm	16 m ³ /h	20282	1	5	0.047
Ø 90 mm	22 m ³ /h	20283	1	5	0.047
Ø 110 mm	33 m ³ /h	20284	1	5	0.047
Grille in ABS plastic with protection against UV rays.					
Outlet connection					
Flow rate					
to be glued					
Ø 75 mm	16 m ³ /h	22359	1	4.5	0.034
Ø 90 mm	22 m ³ /h	22360	1	4.5	0.034
Ø 110 mm	33 m ³ /h	22361	1	4.5	0.034
Ø 125 mm	43 m ³ /h	22362	1	4.5	0.034



Optional standard American size and antivortex in standard American size

Concrete pool - Main drains

NORM main drain

in polyester and fibreglass - 507 mm x 507 mm



DESCRIPTION

Range of drains manufactured in polyester resin and fibreglass. Grille in AISI-316L stainless steel. Optional hydrostatic valve. Minimum depth of installation: 1.5 m. Maximum recommended flow rate down drain: 103 m³/h (0.5 m/s).



Complies with Standard
EN 13451-1/3 2012



Complies with Standards
EN 16713-02 2016

Optional standard American
size

Code	Standard Pack	Standard weight in kg	Standard volume in m ³
------	---------------	-----------------------	-----------------------------------

Grille in stainless steel AISI-316L.

Outlet connection Flow rate
to be glued

Outlet connection	Flow rate	Code	Standard Pack	Standard weight in kg	Standard volume in m ³
Ø 110 mm	42 m ³ /h	20285N	1	16	0.23
Ø 125 mm	51 m ³ /h	20286N	1	17	0.23
Ø 140 mm	66 m ³ /h	20287N	1	18	0.23
Ø 160 mm	95 m ³ /h	20288N	1	19	0.23
Ø 200 mm	103 m ³ /h	20289N	1	20	0.23

Main drain

in polyester and fibreglass - 507 mm x 507 mm



DESCRIPTION

With a gelcoat finish. With optional hydrostatic valve. Maximum recommended flow rate in accordance with standard EN 13451-1.

Code	Standard Pack	Standard weight in kg	Standard volume in m ³
------	---------------	-----------------------	-----------------------------------

Grille in AISI-316L stainless steel. Holes < 8 mm

Outlet connection Flow rate
to be glued

Outlet connection	Flow rate	Code	Standard Pack	Standard weight in kg	Standard volume in m ³
Ø 110 mm	33 m ³ /h	20285	1	11.5	0.132
Ø 125 mm	43 m ³ /h	20286	1	11.5	0.132
Ø 140 mm	54 m ³ /h	20287	1	11.5	0.132
Ø 160 mm	70 m ³ /h	20288	1	11.5	0.132
Ø 200 mm	100 m ³ /h	20289	1	11.5	0.132

Grille in ABS plastic with protection against UV rays.

Outlet connection Flow rate
to be glued

Outlet connection	Flow rate	Code	Standard Pack	Standard weight in kg	Standard volume in m ³
Ø 110 mm	33 m ³ /h	28709	1	11.5	0.132
Ø 125 mm	43 m ³ /h	28710	1	11.5	0.132
Ø 140 mm	54 m ³ /h	28711	1	11.5	0.132
Ø 160 mm	70 m ³ /h	28712	1	11.5	0.132
Ø 200 mm	100 m ³ /h	28713	1	11.5	0.132

Concrete pool - Main drain accessories

Hydrostatic valve



DESCRIPTION

To alleviate the pressure that can build up under the pool shell due to groundwater, it is recommended that a hydrostatic valve and a drainage pipe be fitted to the main drain. Hydrostatic valve to be fitted to the 2" bottom outlet on main drains. Made of white ABS, with stainless steel screw and spring, 1½" male thread.

Code	Standard Pack	Standard weight in kg	Standard volume in m ³
00277	50	2.63	0.01

Drainage pipe



DESCRIPTION

Drainage pipe with 1½" BSP thread connection for main drains with code numbers 01466, 27837 and 27839. Made of ABS.

Code	Standard Pack	Standard weight in kg	Standard volume in m ³
21581	24	3.54	0.021

Concrete pool - Main drain grilles

Flush-fit antivortex cover



DESCRIPTION

Special flush-fit design that enables pool cleaners to go over it without blocking it up. Smooth slopes.

The 415 mm x 415 mm cover (25344) can be fitted to the following main drains:

With stainless steel grille:	With plastic grille:
-20282	-22359
-20283	-22360
-20284	-22361
	-22362

The 570 mm x 570 mm cover (28556) can be fitted to the following main drains:

With stainless steel grille:	With plastic grille:
-20285	-28709
-20286	-28710
-20287	-28711
-20288	-28712

Code	Standard Pack	Standard weight in kg	Standard volume in m ³
25344	1	2.25	0.012
28556	1	4.00	0.032

415 mm x 415 mm, Height: 70 mm
570 mm x 570 mm, Height: 60 mm



Complies with Standard EN 13451-1-3



Complies with Standards EN 16713-02 2016

Concrete pool - Main drain grilles

Ø 200 drain grille in ABS



Complies with Standards
EN 16582-1

DESCRIPTION

Ring support and grille in white ABS. Supplied with grille fixing screws. This grille is for suction chamber done on site.

Code	Standard Pack	Standard weight in kg	Standard volume in m ³
00280	10	3.0	0.031

Ø 200 drain grille in stainless steel



Complies with Standard
EN 13451-1-3



Complies with Standards
EN 16582-1
EN 16713-2

DESCRIPTION

Support ring in white plastic, grille in AISI-316L stainless steel. Supplied with grille fixing screws. Maximum recommended flow rate: 13 m³/h.

Code	Standard Pack	Standard weight in kg	Standard volume in m ³
00279	10	6.0	0.02

Ø 300 drain grille in stainless steel



DESCRIPTION

Support ring in aluminium, grille in AISI-316L stainless steel. Supplied with grille fixing screws. Maximum recommended flow rate: 27 m³/h.

Code	Standard Pack	Standard weight in kg	Standard volume in m ³
00282	4	5.8	0.02

Drain grille in stainless steel



DESCRIPTION

Designed for concrete pools. Support frame and grille in polished stainless steel. Supplied with fixing screws. Other sizes can be made to order.

Code	Standard Pack	Standard weight in kg	Standard volume in m ³
AISI-304L			
Size (mm) Max. recommended flow rate			
00284	1	1.2	0.01
00285	1	2.2	0.01
00286	1	4.0	0.03
00287	1	4.5	0.04
AISI-316L			
Size (mm) Max. recommended flow rate			
30764	1	1.2	0.01
30765	1	2.2	0.01
30766	1	4.0	0.03
30767	1	4.5	0.04

Concrete pool - Main drain grilles

Range of drain grilles

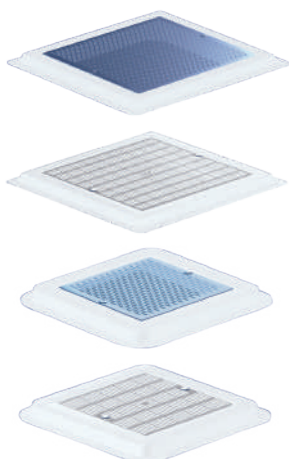

DESCRIPTION

Available in stainless steel and plastic. Frames manufactured in polyester resin and fibreglass with a gelcoat finish. Possibility of fitting antivortex lids with code numbers 25344 and 28556 (see page 100).

	Code	Standard Pack	Standard weight in kg	Standard volume in m ³
Stainless Steel drain grille				
490 mm x 490 mm	28560	1	5.0	0.029
345 mm x 345 mm	28562	1	3.0	0.029
Plastic drain grille				
490 mm x 490 mm	28561	1	4.7	0.029
345 mm x 345 mm	28563	1	2.9	0.029



Drain grille for private pools



DESCRIPTION

Range of drain grilles for use in private and public pools. Optional grilles in plastic or stainless steel. Frames made of plastic. Excellent finish.

	Code	Standard Pack	Standard weight in kg	Standard volume in m ³
Plastic grille 410 x 410 mm	34333	1	-	0.0540
Plastic grille 252 x 252 mm	34331	1	-	0.0129
Stainless Steel grille 410 x 410 mm	34334	1	-	0.0540
Stainless Steel grille 252 x 252 mm	34332	1	-	0.0129

Concrete pool - Inlets

Multiflow system

- The inlet's eyeball is supplied pre-marked with a number of diameters (14-20 and 25). With the help of a punch (also supplied with the inlet) one of the diameters can be cut out at the time of installation.
- Max. recommended flow rate for a max. flow of 4 m/s:
 $\varnothing 14 \text{ mm} = 2.2 \text{ m}^3/\text{h}$, $\varnothing 20 \text{ mm} = 4.5 \text{ m}^3/\text{h}$, $\varnothing 25 \text{ mm} = 7 \text{ m}^3/\text{h}$



NORM return inlets



DESCRIPTION

Range of inlets suitable for installation in public and private pools. Manufactured in white ABS with UV treatment.



	Code	Standard Pack	Standard weight in kg	Standard volume in m ³
NORM return inlet for concrete pools	56498	24	4.5	0.020

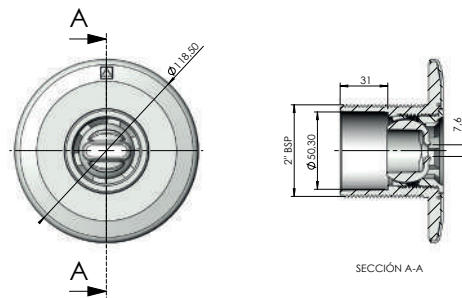

Multiflow return inlet to be glued



DESCRIPTION

To be glued to a $\varnothing 50 \text{ mm}$ PN 10 pipe. Made of white ABS.



	Code	Standard Pack	Standard weight in kg	Standard volume in m ³
Standard inlet	24413	40	4.0	0.020

Concrete pool - Inlets

Threaded Multiflow return inlet



DESCRIPTION

Outer 2" thread and Ø 50 mm inner wall to be glued. Made of ABS. Recommended for installation with wall conduits: codes 15658 and 15659.

	Code	Standard Pack	Standard weight in kg	Standard volume in m ³
White	00295	24	4.35	0.020
Beige	00295CL090	24	4.35	0.020
Light Grey	00295CL129	24	4.35	0.020
Anthracite Grey	00295CL144	24	4.35	0.020



Complies with Standards
EN 16582-1
EN 16713-2



DESCRIPTION

To be glued to Ø 63 mm PN 6 outer wall and Ø 50 mm inner wall. Made of ABS. Recommended for installation with wall conduits: code numbers 15661 and 15660.

	Code	Standard Pack	Standard weight in kg	Standard volume in m ³
White	00298	24	4.24	0.020
Beige	00298CL090	24	4.24	0.020
Light Grey	00298CL129	24	4.24	0.020
Anthracite Grey	00298CL144	24	4.24	0.020



Complies with Standards
EN 16582-1
EN 16713-2

Return inlet/suction nozzle

for high flow rates



DESCRIPTION

Return inlet for large flow rates that can also be used as a suction nozzle. Maximum return flow rate of 30m³/h for a maximum flow rate speed of 4 m/s. Maximum suction flow rate of 5 m³/h for a maximum flow rate speed of 0.5 m/s. PVC body. Connection for Ø 75 or Ø 90mm pipe. Inlets can be installed into bushing 43590 (see page 133). Grille can be adjusted in any direction.

	Code	Standard Pack	Standard weight in kg	Standard volume in m ³
	41520	16	4.20	0.021



Complies with Standards
EN 16582-1
EN 16713-2

Inlet with Ø 20 mm ball to be glued



DESCRIPTION

Manufactured in white ABS. To be glued to a Ø 50 mm PN 10 pipe.

	Code	Standard Pack	Standard weight in kg	Standard volume in m ³
Standard inlet	33501	50	2.9	0.020



Complies with Standards
EN 16582-1
EN 16713-2

Concrete pool - Inlets

Return nozzle



Complies with Standards
EN 16582-1
EN 16713-2

DESCRIPTION

In weatherproof, UV-resistant ABS. 3 adjustable positions. (100%, 65%, 35%). Maximum recommended flow rate compliant with standard EN 13451-1: 13.5 m³/h. Connection: outer Ø 63 mm wall.

	Code	Standard Pack	Standard weight in kg	Standard volume in m ³
	15863	24	3.4	0.020

Pool floor return inlet



00303



00303CL090



00303CL129



00303CL144



Complies with Standards
EN 16582-1
EN 16713-2

DESCRIPTION

All-in-one return inlet and suction nozzle. Adjustable flow rate. Made of ABS plastic and screws in stainless steel. Maximum recommended flow rate compliant with standard EN 13451-1: 12 m³/h.

	Code	Standard Pack	Standard weight in kg	Standard volume in m ³
Outer 2" thread, int. Ø 50 mm				
White	00303	24	5.0	0.020
Beige	00303CL090	24	5.0	0.020
Light Grey	00303CL129	24	5.0	0.020
Anthracite Grey	00303CL144	24	5.0	0.020
To glue onto Ø 63 mm PN 6, inner Ø 50 mm	20140	20	4.4	0.021

3" adjustable pool floor return inlet



DESCRIPTION

Made of white ABS plastic. Suction. Flow rate adjusted by turning the grille. Suction surface area: 0.015 m². Outer Ø 295 mm wall. Flow rate (0.4 m/s) 20 m³/h. Max. recommended flow rate compliant with standard EN 13451-1: 26 m³/h (0.5 m/s.).

	Code	Standard Pack	Standard weight in kg	Standard volume in m ³
Grille in AISI-304 stainless steel	08317	2	2.65	0.047
Grille in white ABS	11796	2	2.65	0.047

Pool floor return inlet with swivel joint



22353



22353CL090



22353CL129



22353CL144



Complies with Standards
EN 16582-1
EN 16713-2

DESCRIPTION

Swivel body in PVC. Cover in ABS. Adjuster screw in POM. Maximum flow rate of 10 m³/h. Fits to Ø 75 mm piping and wall conduit with code number 21248.

	Code	Standard Pack	Standard weight in kg	Standard volume in m ³
White	22353	24	4.1	0.022
Beige	22353CL090	24	4.1	0.022
Light Grey	22353CL129	24	4.1	0.022
Anthracite Grey	22353CL144	24	4.1	0.022

Concrete pool - Inlets



Wall conduit for pool floor return

inlet with swivel joint (Net'n'Clean reduction piping)



DESCRIPTION

Diameter of the piping adjusted to glue in inlet 22353. Connection to piping for Ø 50 mm inner wall and Ø 63 mm outer wall.

Code	Standard Pack	Standard weight in kg	Standard volume in m ³
21248	12	7.3	0.032

Suction nozzle



DESCRIPTION

To be glued to Ø 63 mm and Ø 50 mm piping. Maximum pressure: 6 bar. Made of ABS. 1½" thread. Recommended for installation with wall conduits: code numbers 15661 and 15660.

Code	Standard Pack	Standard weight in kg	Standard volume in m ³
00300	24	3.62	0.020
00300CL090	24	3.62	0.020
00300CL129	24	3.62	0.020
00300CL144	24	3.62	0.020



Complies with Standards
EN 16582-1
EN 16713-2



Suction nozzle



DESCRIPTION

Outer 2" thread, Ø 50 mm inner wall. Maximum pressure: 6 bar. Made of white ABS with 1½" threaded plug. Recommended for installation with wall conduits (codes 15658 and 15659).



Complies with Standards
EN 16582-1
EN 16713-2

Code	Standard Pack	Standard weight in kg	Standard volume in m ³
00301	24	3.8	0.020



Suction nozzle



DESCRIPTION

To be glued to a Ø 50 PN 10 pipe. Made of white ABS with 1½" threaded plug. For end connector 07958 and push fit connector 01393. Recommended for installation with wall conduits (codes 15658 and 15659).



Complies with Standards
EN 16582-1
EN 16713-2

Code	Standard Pack	Standard weight in kg	Standard volume in m ³
24415	50	3.72	0.02

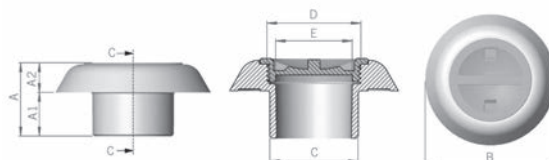

Concrete pool - Inlets



Suction inlet



DESCRIPTION

To be glued to a Ø 63 mm pipe. Body and grille in ABS plastic, screws in stainless steel. Application on wall. Its characteristics make this nozzle particularly suitable for overflow channels. Maximum flow rate: 4.5 m³/h.

	Code	Standard Pack	Standard weight in kg	Standard volume in m ³
	00302	12	3.1	0.016

Hydromassage kit



DESCRIPTION

Made up of a return inlet and wall conduit fitted with an air inlet and a venturi. Two wall conduit lengths available. Ø 50 mm water connection pipe and Ø 20 mm air suction pipe.



	Code	Standard Pack	Standard weight in kg	Standard volume in m ³
Hydromassage kit for concrete pools:				
Length of wall conduit 190 mm				
White	32113	12	3.5	0.021
Beige	32113CL090	12	3.5	0.021
Light Grey	32113CL129	12	3.5	0.021
Anthracite Grey	32113CL144	12	3.5	0.021
Length of wall conduit 280 mm				
White	32370	12	3.6	0.021
Beige	32370CL090	12	3.6	0.021
Light Grey	32370CL129	12	3.6	0.021
Anthracite Grey	32370CL144	12	3.6	0.021
Hydromassage kit for concrete pools with a liner:				
Length of wall conduit 190 mm				
White	31443	12	3.5	0.021
Beige	31443CL090	12	3.5	0.021
Light Grey	31443CL129	12	3.5	0.021
Anthracite Grey	31443CL144	12	3.5	0.021
Length of wall conduit 275 mm				
White	32371	8	3.5	0.021
Beige	32371CL090	8	3.5	0.021
Light Grey	32371CL129	8	3.5	0.021
Anthracite Grey	32371CL144	8	3.5	0.021

Concrete pool - Stainless Steel Inlets

Return inlet with Ø 20 mm ball



Complies with Standards
EN 16582-1
EN 16713-2

DESCRIPTION

1½" external thread. Manufactured in AISI-316L stainless steel. Maximum recommended flow of 4.5 m³/hour according to EN 16582-1 and EN 16713-2 standards if installed at a maximum of 500 mm below pool water level. Ø 20mm ball.

	Code	Standard Pack	Standard weight in kg	Standard volume in m³
Length 35 mm	32994	1	0.3	0.001
Length 50 mm	16325	1	0.3	0.001
Length 70 mm	16326	1	0.5	0.001

Return inlet with Ø 25 mm ball



Complies with Standard
EN 13451-1-3



Complies with Standards
EN 16582-1
EN 16713-2

DESCRIPTION

1½" external thread. Manufactured in AISI-316L stainless steel. Maximum recommended flow according to EN 13451-3 standard: 7 m³/h. Ø 25 mm ball.

	Code	Standard Pack	Standard weight in kg	Standard volume in m³
Length 35 mm	69874	1	0.3	0.001
Length 50 mm	69875	1	0.3	0.001
Length 70 mm	69876	1	0.5	0.001

Adjustable pool floor return inlet



Complies with Standard
EN 13451-1-3



Complies with Standards
EN 16582-1
EN 16713-2

DESCRIPTION

2" external thread. Made of AISI-316L stainless steel. Can be fitted in concrete and prefabricated pools. The water flow can be adjusted by loosening or tightening the central screw. Max. recommended flow rate complaint with standard EN 13451-3: 14 m³/h.

	Code	Standard Pack	Standard weight in kg	Standard volume in m³
	15839	1	0.9	0.002

Suction nozzle



Complies with Standard
EN 13451-1-3



Complies with Standards
EN 16582-1
EN 16713-2

DESCRIPTION

1½" external thread. Manufactured in AISI-316L stainless steel. Push-fit connection 05684 required (see page 362).

	Code	Standard Pack	Standard weight in kg	Standard volume in m³
Length 50 mm	16328	1	0.2	0.001
Length with cover: 50 mm	21644	1	0.3	0.001

Concrete pool - Stainless Steel Inlets

Adjustable return inlet

DESCRIPTION

Manufactured in chrome-plated brass. Grille in AISI-304L stainless steel.



Complies with Standard
EN 13451-1-3



Complies with Standards
EN 16582-1
EN 16713-2

	Code	Standard Pack	Standard weight in kg	Standard volume in m ³
Max. flow rate: 21 m ³ /h 2" inner thread	00312	12	7.0	0.013
Max. flow rate: 40 m ³ /h 3" inner thread	00313	6	10.0	0.014

Suction nozzle with sliding cover

DESCRIPTION

Manufactured in chrome-plated brass. Faceplate in AISI-304L stainless steel. Pressure connection, 2" internal thread. Sleeve 01392 is needed (see page 362) couples to hose.



Complies with Standard
EN 13451-1-3



Complies with Standards
EN 16582-1
EN 16713-2

	Code	Standard Pack	Standard weight in kg	Standard volume in m ³
	00315	12	8.0	0.008

Suction nozzle with threaded cover

DESCRIPTION

Made of chrome plated brass. Screws into 2" inner thread (01395 coupling is required for hose).



Complies with Standard
EN 13451-1-3



Complies with Standards
EN 16582-1
EN 16713-2

	Code	Standard Pack	Standard weight in kg	Standard volume in m ³
	00317	12	10.0	0.012

Concrete pool - Wall bushings

Wall conduits in ABS



DESCRIPTION

Range of 300 mm long conduits for Ø 2" inlets and Multiflow that can be cut to different lengths, depending on the thickness of the pool wall. Made of ABS. The ribs of the end plates have holes for fitting the wall conduit to the pool structure, which makes assembly straightforward.

	Code	Standard Pack	Standard weight in kg	Standard volume in m ³
Wall conduit in ABS with 2" rear male thread and Ø 50 mm smooth inner wall				
2" front female thread nozzles	15658	15	4.3	0.040
Smooth Ø 59.3 mm front connection for nozzles to be glued to Ø 63 mm piping, 6-bar piping and MINI projector (33684)	15661	15	4.2	0.040
Wall conduit in ABS with smooth Ø 63 mm rear connection and smooth Ø 50 mm inner wall				
2" front female thread nozzles	15659	15	4.2	0.040
Smooth Ø 59.3 mm front connection for nozzles to be glued to Ø 63 mm piping, 6-bar piping and MINI projector (33684)	15660	15	5.6	0.040

Wall conduits in PVC



	Code	Standard Pack	Standard weight in kg	Standard volume in m ³
Wall conduit in Grey PVC. 150 mm long				
2" outer thread + Ø 50 mm inner, 2" inner thread	00322	40	8.2	0.040
Wall conduit in Grey PVC. 300 mm long				
2" female and male thread connection	00323	20	8.9	0.040
2" rear male thread pipe connection or smooth inner wall for MINI projector (33684)	00324	20	8.5	0.040
2" outer thread + Ø 50 mm inner, 1½" inner thread	00325	20	8.4	0.040
2" outer thread + Ø 50 mm inner wall, Ø 50 mm inner wall specially for nozzles 00289, 07957, 00304, 00305 and 00306	00326	20	8.4	0.040

Wall conduits in Stainless Steel



	Code	Standard Pack	Standard weight in kg	Standard volume in m ³
Wall conduit in AISI-304L S.S. Both ends with 1½" inner thread. With earth connection				
Length 240 mm	00327	1	0.7	0.003
Length 340 mm	00328	1	0.8	0.005

Concrete pool - Winter accessories

Winter plugs



	Code	Standard Pack	Standard weight in kg	Standard volume in m ³
For protect from freezing				
For covering 1½" inlets	53849	-	-	-
For covering 2" inlets	06212	-	-	-

Liner and pref. pool - 15 L Skimmers

- All of the components that are exposed in this range of skimmers come with a UV treatment.
- Made of ABS, they come with a weir flap and a flow regulator check valve.
- Bottom suction nozzle connection: 1½" inner thread, 2" outer thread.
- Simultaneous connection to the main drain: Ø 50 mm inner wall.
- Overflow connection: Ø 40 mm.
- Leaf trap.
- Recommended flow rate: 7.5 m³/h.
- It is recommended that one skimmer be installed for every 25 m² of water surface area.
- All skimmers come in two different models: the model with inserts and the PARKER model, which is supplied with self-tapping screws.



Skimmer with standard mouth opening



DESCRIPTION

Supplied with adhesive gasket, bi-injection moulded frame, flange and screws.



Complies with Standards
EN 16582-1
EN 16713-2

	Code	Standard Pack	Standard weight in kg	Standard volume in m³
Comes with round snap-on cover				
White	01461	1	4.0	0.059
Beige	01461CL090	1	4.0	0.059
Light Grey	01461CL129	1	4.0	0.059
Anthracite Grey	01461CL144	1	4.0	0.059
Comes with square snap-on cover				
White	01462	1	4.2	0.059

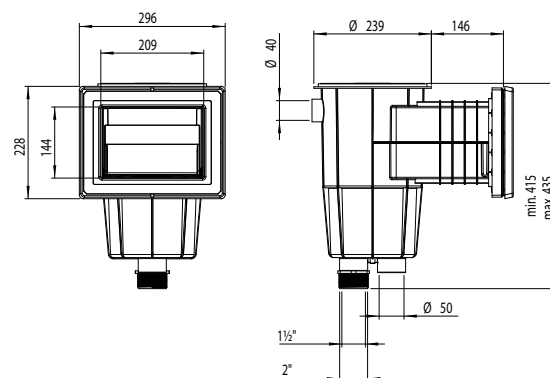

Liner and pref. pool - 15 L Skimmers

Skimmer

with wide mouth opening



34413



34413CL090



34413CL129



34413CL144

DESCRIPTION

Supplied with adhesive gaskets, flange and screws.

	Code	Standard Pack	Standard weight in kg	Standard volume in m ³
Round cover, small embellisher				
White	01463	1	5.28	0.12
Square cover with round faceplate, small embellisher				
White	01464	1	5.28	0.12
Square cover with square faceplate, big embellisher that covers the flange				
White	34413	1	5.04	0.12
Beige	34413CL090	1	5.04	0.12
Light Grey	34413CL129	1	5.04	0.12
Anthracite Grey	34413CL144	1	5.04	0.12



Complies with Standards
EN 16582-1
EN 16713-2

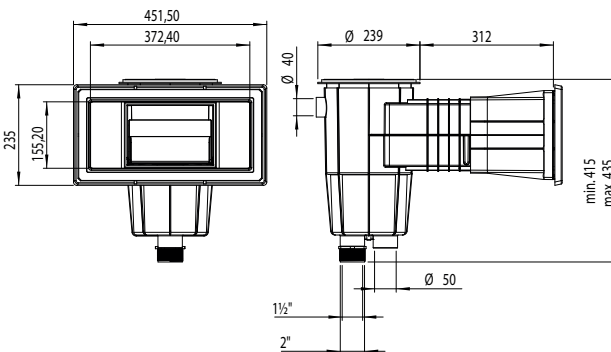

Skimmer for polyester pools

with wide mouth



DESCRIPTION

15L skimmer, square cover. This skimmer doesn't include gaskets. The installer should insure water tightness of skimmer mouth.

	Code	Standard Pack	Standard weight in kg	Standard volume in m ³
White	06470	1	4.32	0.12



Complies with Standards
EN 16582-1
EN 16713-2

Liner and pref. pool - 15 L Skimmers

Panel Protect skimmer

inside assembly



Complies with Standards
EN 16582-1
EN 16713-2

DESCRIPTION

Supplied with adhesive gaskets, flange and screws. Skimmers specially designed for panel pools. The wide opening assembly should be fitted to the panel from the inside. Supplied with glue. Item 30866 is compatible with EASYCOLOR Inlet sheath item 73166CLXXX to an easy color change of the skimmer embellisher and the floater. This sheath could be installed without change the skimmer mouth what is very practical to renew or upgrade pools.

	Code	Standard Pack	Standard weight in kg	Standard volume in m ³
15 l Panel Protect skimmer	30866	1	5.13	0.116
wide opening, square cover	30884	1	0.20	0.001
Glue for ABS				



73166CL129



73166CL090



73166CL1144

Liner and pref. pool - 17.5 L Skimmers

- All of the components that are exposed in this range of skimmers come with a UV treatment.
- Made of ABS, they come with a weir flap and a flow regulator check valve.
- Bottom suction nozzle connection: 1½" inner thread, 2" outer thread.
- Simultaneous connection to the main drain: Ø 50 mm inner wall.
- Overflow connection: Ø 40 mm.
- Leaf trap.
- Recommended flow rate: 7.5 m³/h.
- It is recommended that one skimmer be installed for every 25 m² of water surface area.
- All skimmers come in two different models: the model with inserts and the PARKER model, which is supplied with self-tapping screws.

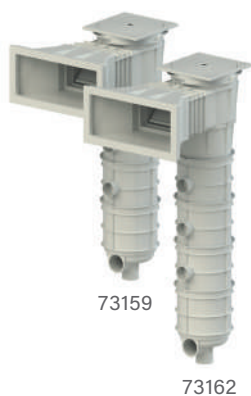

73159

73162

Filtering skimmer

ASTRALPOOL



DESCRIPTION

17.5L skimmer with cartridge system integrated. Made of ABS with UV treatment. Incorporate gate, regulator lid height, skimmer basket and 2 cartridge filters. Upper Access water connection Ø 32 m, bottom connections of Ø 63 mm and lateral of Ø 50 mm. Lateral connections are for connecting suction nozzles.

The color change is proposed with an inlet sheath, both the embellisher and the floater. This sheath could be installed without changing the skimmer mouth what is very practical to renew or upgrade pools.

	Code	Standard Pack	Standard weight in kg	Standard volume in m³
Prefabricated pools - white⁽¹⁾				
Filtering skimmer with 2 cartridges 16m³	73159	1	12	0.32
Filtering skimmer with 2 cartridges 20m³	73162	1	13	0.32
Panels pools - white				
Filtering skimmer with 2 cartridges 16m³	73160	1	12.5	0.32
Filtering skimmer with 2 cartridges 20m³	73163	1	13.5	0.32
EASYCOLOR - Inlet sheath⁽²⁾				
Light Grey - inlet sheath	73166CL129	1	1.22	0.02
Anthracite - inlet sheath	73166CL144	1	1.22	0.02
Beige - inlet sheath	73166CL090	1	1.22	0.02
Cartridge⁽³⁾				
Cartridge 16 m³/h - 15 microns	73164	1	1.64	0.02
Cartridge 20 m³/h - 15 microns	73165	1	2.24	0.026



73166CL129



73166CL144



73166CL090

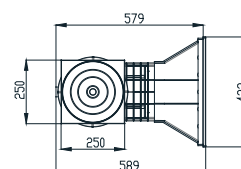
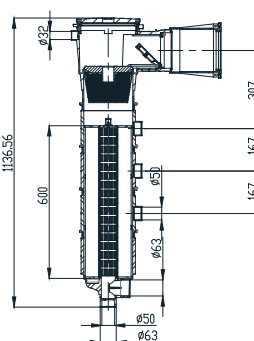
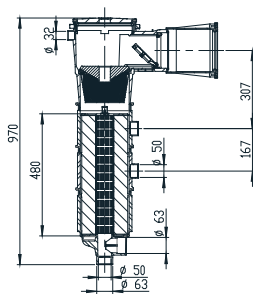

(1) Codes 73159 and 73162 will be delivered with 2 sets of screws – DIN 7982 A4 5.5x25 and 32.
 (2) Also compatible with skimmers 30866, 30867 and 34413
 (3) 2-year limited warranty - please refer to the instruction manual



Liner and pref. pool - 17.5 L Skimmers

Skimmer SPS 250

ASTRALPOOL 



POOL SHELL
EQUIPMENT



DESCRIPTION

Range of 17L skimmers suitable for installation in residential pools. The short length of 250 mm makes them ideal for installation in pools made from expanded polystyrene blocks. Their configuration also takes the water level up to the edge of the coping stone. Manufactured in ABS with UV protection, the SPS 250 comes with a weir flap, flow regulator and basket. Recommended flow rate of 7.5 m³/h. Install one skimmer every 25 m² of water line surface area. Connections under Ø 63 mm and 2", water overflow connection of Ø 32 mm.

	Code	Standard Pack	Standard weight in kg	Standard volume in m ³
Skimmer with inserts	58382	1	3.50	0.037



Complies with Standards
EN 16582-1

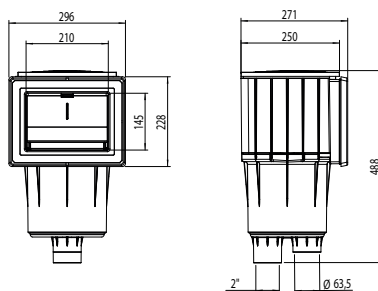

NORM skimmer

ASTRALPOOL 



DESCRIPTION

17.5L skimmer range suitable for installation in public and private pools. Manufactured in ABS with UV treatment, it comes with a weir flap, flow regulator, lid height regulation and basket. The water inlet is 495 x 80 mm. Recommended flow rate of 7.5 m³/h. Install one skimmer every 25 m² of water line surface area. Connections under 1½" and 2", water overflow connection of Ø 40 mm.

	Code	Standard Pack	Standard weight in kg	Standard volume in m ³
--	------	---------------	-----------------------	-----------------------------------

For prefabricated pools with inserts

White	56176	1	5.61	0.182
Beige	56176CL090	1	5.61	0.182
Light Grey	56176CL129	1	5.61	0.182
Anthracite Grey	56176CL144	1	5.61	0.182

For prefabricated pools without inserts

White	56299	1	5.61	0.182
Beige	56299CL090	1	5.61	0.182
Light Grey	56299CL129	1	5.61	0.182
Anthracite Grey	56299CL144	1	5.61	0.182
NORM 6° for prefabricated pools with inserts	57114	1	5.61	0.182



56176



56176CL090



56176CL129



56176CL144



Complies with Standards
EN 16582-1
EN 16713-2

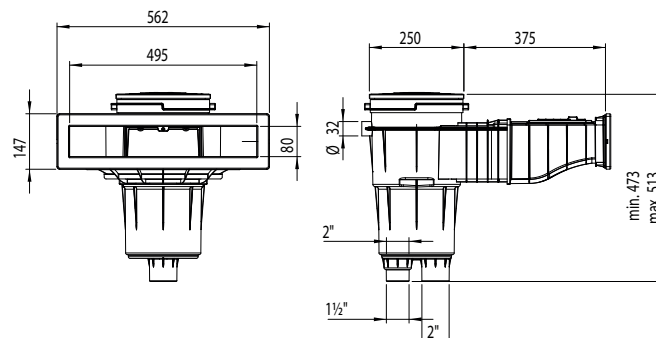

Liner and pref. pool - 17.5 L Skimmers

Skimmer with standard mouth opening



DESCRIPTION

Supplied with adhesive gaskets, flange and screws.



11309CL090



11309CL129



11309CL144



Complies with Standards
EN 16582-1
EN 16713-2

	Code	Standard Pack	Standard weight in kg	Standard volume in m ³
Skimmer with square cover				
White	11309	1	5.30	0.062
Beige	11309CL090	1	5.30	0.062
Light Grey	11309CL129	1	5.30	0.062
Anthracite Grey	11309CL144	1	5.30	0.062
Skimmer 6° for polyester pool with square cover, with inserts				
White	35664	1	6.00	0.062
Skimmer 6° for polyester pool with round cover, without inserts				
White	68108	1	6.00	0.062
Beige	68108CL090	1	6.00	0.062
Light grey	68108CL129	1	6.00	0.062
Anthracite grey	68108CL144	1	6.00	0.062

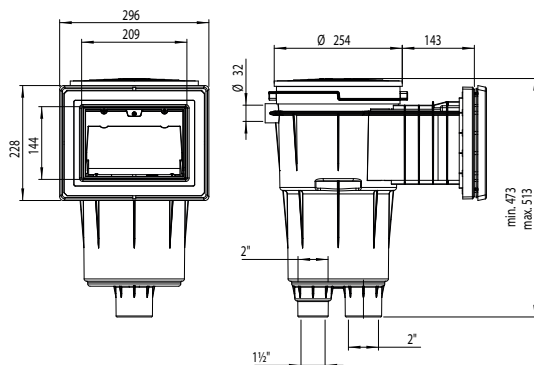

Liner and pref. pool - 17.5 L Skimmers

Skimmer with standard opening and extended throat



DESCRIPTION

Supplied with adhesive gaskets, flange and screws.

Code	Standard Pack	Standard weight in kg	Standard volume in m ³
------	---------------	-----------------------	-----------------------------------

With square cover

White	11310	1	5.90	0.077
Beige	11310CL090	1	5.90	0.077
Light Grey	11310CL129	1	5.90	0.077
Anthracite Grey	11310CL144	1	5.90	0.077



11310CL090



11310CL129



11310CL144



Complies with Standards
EN 16582-1
EN 16713-2

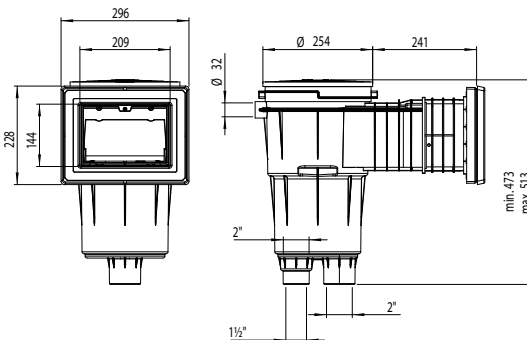

* Available until end of stocks

Skimmer with wide mouth opening



DESCRIPTION

Supplied with adhesive gaskets, flange and screws.

Code	Standard Pack	Standard weight in kg	Standard volume in m ³
------	---------------	-----------------------	-----------------------------------

With square cover

White	11311	1	6.52	0.135
Beige	11311CL090	1	6.52	0.135
Light Grey	11311CL129	1	6.52	0.135
Anthracite Grey	11311CL144	1	6.52	0.135

With square cover for PARKER models

White	11317	1	6.52	0.135
Beige	11317CL090	1	6.52	0.135
Light Grey	11317CL129	1	6.52	0.135
Anthracite Grey	11317CL144	1	6.52	0.135

With square cover - 6° for polyester pool

White	35665	1	6.12	0.135
-------	-------	---	------	-------



11311CL090



11311CL129



11311CL144



Complies with Standards
EN 16582-1
EN 16713-2

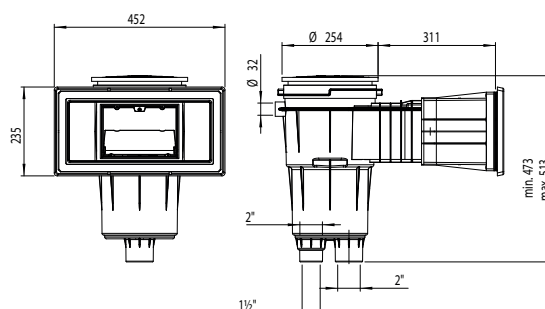

Liner and pref. pool - 17.5 L Skimmers



Skimmer with wide opening and extended throat



DESCRIPTION

Supplied with adhesive gaskets, flange and screws.



Complies with Standards
EN 16582-1
EN 16713-2

	Code	Standard Pack	Standard weight in kg	Standard volume in m ³
Square cover	11313	1	7.00	0.161
Square cover for PARKER models	11314	1	7.00	0.161

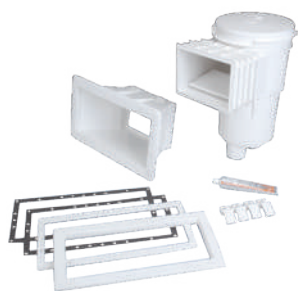

Panel Protect skimmer inside assembly



DESCRIPTION

Skimmers for panel pools. The wide opening assembly should be fitted to the panel from the inside. Supplied with glue. Item 30867 is compatible with EASYCOLOR Inlet sheath item 73166CLXXX to an easy color change of the skimmer embellisher and the floater. This sheath could be installed without change the skimmer mouth what is very practical to renew or upgrade pools.

	Code	Standard Pack	Standard weight in kg	Standard volume in m ³
17.5 l Panel Protect skimmer wide opening, square cover	30867	1	6.20	0.116
Glue for ABS	30884	25	5.05	0.12

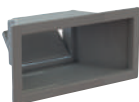

73166CL129



73166CL090



73166CL1144



Complies with Standards
EN 16582-1
EN 16713-2

Liner and pref. pool - Skimmer accessories

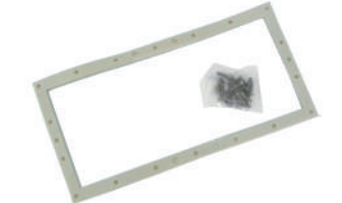
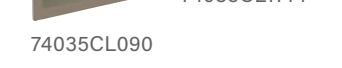
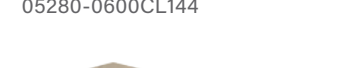
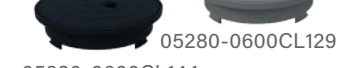
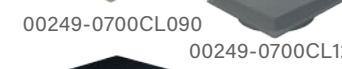
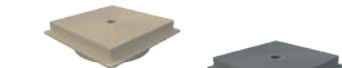
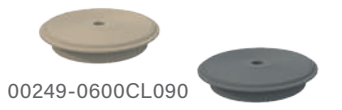

Covers for 15 l skimmers



	Code	Standard Pack	Standard weight in kg	Standard volume in m ³
Round cover, round face plate				
Beige	00249-0600CL090	23	7.9	0.069
Light Grey	00249-0600CL129	23	7.9	0.069
Anthracite Grey	00249-0600CL144	23	7.9	0.069
Round cover, square face plate				
Beige	00249-0700CL090*	13	6.9	0.069
Light Grey	00249-0700CL129*	13	6.9	0.069
Anthracite Grey	00249-0700CL144*	13	6.9	0.069

* Compatibles with level regulator 15862 for a color customization of the level regulator.

Covers for 17.5 l skimmers



	Code	Standard Pack	Standard weight in kg	Standard volume in m ³
Round cover, round face plate				
Beige	05280-0600CL090	15	8	0.069
Light Grey	05280-0600CL129	15	8	0.069
Anthracite Grey	05280-0600CL144	15	8	0.069
Round cover, square face plate				
Beige	05280-0700CL090	15	8	0.069
Light Grey	05280-0700CL129	15	8	0.069
Anthracite Grey	05280-0700CL144	15	8	0.069

EASYCOLOR - Inlet Sheath

for wide mouth skimmers



DESCRIPTION

The EASYCOLOR inlet sheath kit allows to change the color of the skimmers wide mouth items 01463, 01464, 11311, 11313, 11314 and 11317, both the embellisher and the floater. This sheath could be installed without change the skimmer mouth what is very practical to renew or upgrade pools. This new kit includes inlet sheath, floater, flanges and embellisher.

	Code	Standard Pack	Standard weight in kg	Standard volume in m ³
Beige - inlet sheath	74035CL090	1	1.22	0.02
Light Grey - inlet sheath	74035CL129	1	1.22	0.02
Anthracite Grey - inlet sheath	74035CL144	1	1.22	0.02

Double gasket kits

for skimmers



DESCRIPTION

Kits made up of a double gasket and the screws necessary for the installation of skimmers in panel pools. Made of TPE, the kit enables the installation of various accessories in pool shells and protects the panelling from coming into contact with water. Easy to install. Prevents corrosion of the panelling in the area that has been die cut.

	Code	Standard Pack	Standard weight in kg	Standard volume in m ³
Inserts for wide openings	14516-0500	50	-	0.070
Self-tapping screws for wide openings	14516-0600	50	-	0.070
Inserts for standard openings	27124-0500	80	-	0.035
Self-tapping screws for standard openings	27124-0600	80	-	0.035
Inserts for Norm openings	57289-0500	40	-	0.070
Self-tapping screws for Norm openings	57289-0600	40	-	0.070



Liner and pref. pool - 17.5 L S.S. Skimmers

SLIM: S.S. Skimmer A-500

Large mouth



DESCRIPTION

In AISI-316L stainless steel. With Ø 50 mm overflow, basket and lid in stainless steel, both included. It has accommodation to mount the level regulator valve 73453 (see page 93). With connection for equipotential connection. Flow recommended 7.5 m³ / h. Water level +/- 8 cm. basket capacity 1,2L.



Complies with Standard
EN 13451-1-3



Complies with Standards
EN 16582-1
EN 16713-2

	Code	Standard Pack	Standard weight in kg	Standard volume in m ³
Mouth width 500 mm, 6° inclination	72744	1	14.84	0.136
Mouth width 650 mm, 6° inclination	72743	1	14.84	0.136

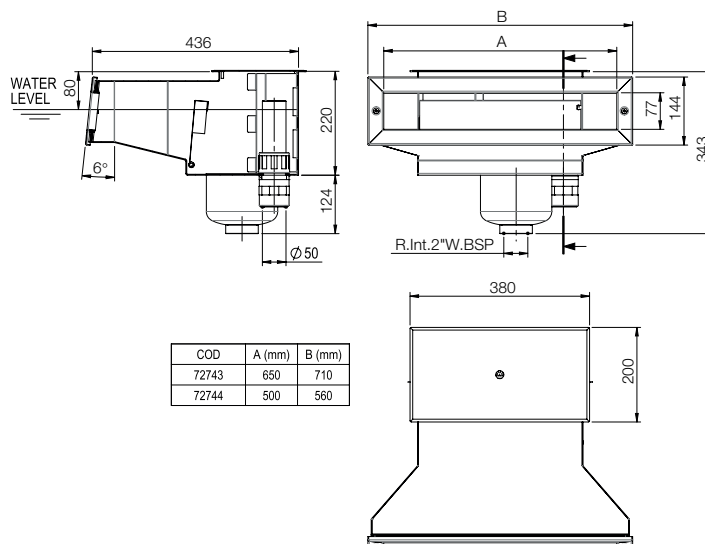

Liner and pref. pool - S.S. Skimmer accessories

Coupling kit

for stainless steel skimmers



Complies with Standards
EN 16582-1
EN 16713-2

DESCRIPTION

For liner, prefabricated and panel pools. Includes: 2 elastic gaskets, AISI-316 stainless steel frame and screws for assembling.

	Code	Standard Pack	Standard weight in kg	Standard volume in m ³
For A-100, A-201 and A-202 skimmers (00254, 07520 and 07610)	07525	1	0.78	0.002
For A-400 skimmer (code 07523)	07526	1	1.13	0.01

Liner and prefabricated pool - Main drains

Pool main drains information

How affects EN 16713-02 : 2016 main drains in residential pools

NEW POOL	POOL RENOVATION
----------	-----------------

Suction rate: insure a maximum of 0.5 m/s

	ANTI-VORTEX COVER	NON ANTI-VORTEX COVER	WITH MAIN DRAIN BODY CHANGE	UNCHANGED MAIN DRAIN BODY
RISK OF ENTRAPMENT How to prevent it?	Number of main drains per pool: 1	Number of main drains per pool: 2 balanced main drains, distanced at minimum 1 meter. And if any of the 2 main drain is blocked the remaining one should be able to absorb 100% of the installation flow.	Applies new pool rules	Install an anti-vortex grille on pre-installed main drain

CAVITY DIMENSION Main drain should respect a certain cavity dimensions according to a mathematical rule.

OTHERS Other requisites are considered to define that a main drain in compliant with EN, like design. e.g. the design of the grill to avoid human body parts or hair entrapment.

Only with the fulfillment of all requisites of the standard, a Compliance Certification can be delivered!

*Anti-vortex plate is a special component installed in the suction line to control the turbulence in a flowing fluid. These plates allows to control the velocity of the fluid thus preventing cavitation in the fluid.

Liner and prefabricated pool - Main drains

- All main drains in the range are supplied with UV protection.
- To prevent the risk of suction, install the main drains according to local regulations.
- Recommended use: Maximum suction rate of 0.5 m/s.

NORM main drain

ASTRALPOOL 



DESCRIPTION

Range of main drains suitable for installation in public and private pools. Supplied with flat or antivortex grilles. Manufactured in ABS with UV treatment, fitted with a 2" side outlet and a 1½" bottom outlet connection, bottom outlet covered by semi-die cut tab.



Complies with Standards
EN 16582-1
EN 16713-2

	Code	Standard Pack	Standard weight in kg	Standard volume in m ³
Flat grating with inserts				
White	56380	4	10.60	0.069
Beige	56380CL090	4	10.60	0.069
Light Grey	56380CL129	4	10.60	0.069
Anthracite Grey	56380CL144	4	10.60	0.069
Flat grating without inserts				
White	56381	4	10.60	0.069
Beige	56381CL090	4	10.60	0.069
Light Grey	56381CL129	4	10.60	0.069
Anthracite Grey	56381CL144	4	10.60	0.069
Antivortex grating with inserts				
White	56382	4	10.60	0.069
Beige	56382CL090	4	10.60	0.069
Light Grey	56382CL129	4	10.60	0.069
Anthracite Grey	56382CL144	4	10.60	0.069
Antivortex grating without inserts				
White	56383	4	10.60	0.069
Beige	56383CL090	4	10.60	0.069
Light Grey	56383CL129	4	10.60	0.069
Anthracite Grey	56383CL144	4	10.60	0.069

Mini main drain

ASTRALPOOL 



DESCRIPTION

Side outlet drain assembly with 2" inner thread. Made of white ABS with grille fixed to flange. Suction velocity at grille of 0.5 m/s and flow rate of 11 m³/h. The slots in the grille are no larger than 8 mm, in compliance with regulations. M5 screws and brass inserts for fastening the flange and grille. Can be used in concrete spas and side suction inlets.



Complies with Standards
EN 16582-1

	Code	Standard Pack	Standard weight in kg	Standard volume in m ³
Mini main drain - White	27814	4	2.64	0.013

Liner and prefabricated pool - Main drains

Ø 290 mm main drain

PARKER model



DESCRIPTION

2" side outlet and 1½" bottom outlet. Specially for liner pools. Built completely in white ABS. Comes with screws in stainless steel and synthetic adhesive gaskets. Side outlet for testing water tightness. Bottom outlet for plug for fitting a hydrostatic valve code 00277 (see page 100) and drainage tube code 21581 (see page 100). Suction speed of 0.5 m/s. Maximum recommended flow rate: 13 m³/h. Fitted flush to pool floor for total drainage.



	Code	Standard Pack	Standard weight in kg	Standard volume in m³
Main drain of Ø 290 mm for liner pool	00270	4	5.71	0.044

Round Ø 200 mm main drain

with antivortex grille



DESCRIPTION

Made of white ABS. 2" side outlet and 1½" bottom outlet. Bottom outlet covered by a semi-die cut tab, which may be removed if necessary. A drainage pipe (code drainage code 21581, see page 100). Max. flow rate: 13 m³/h.



	Code	Standard Pack	Standard weight in kg	Standard volume in m³
	27125	4	3.543	0.033

Round Ø 200 mm main drain

with flat grille



DESCRIPTION

Made of white ABS. 2" side outlet and 1½" bottom outlet. Bottom outlet covered by a semi-die cut tab, which may be removed if necessary. A drainage pipe (code drainage code 21581, see page 100). Max. flow rate: 13 m³/h.



	Code	Standard Pack	Standard weight in kg	Standard volume in m³
	27838	4	3.391	0.033

Liner and prefabricated pool - Main drains

Ø 210 mm main drain

with ABS grille



Complies with Standards
EN 16582-1

DESCRIPTION

2" side outlet. Body and grille in ABS. Comes with self-adhesive gaskets, flange and screws. Maximum recommended flow rate: 13 m³/h.

	Code	Standard Pack	Standard weight in kg	Standard volume in m ³
Ø 210 mm main drain with ABS grille				
White	00271	4	4.0	0.033
Beige	00271CL090	4	4.0	0.033
Light Grey	00271CL129	4	4.0	0.033
Anthracite Grey	00271CL144	4	4.0	0.033
Ø 210 mm main drain with ABS grille, Parker				
White	06474	4	4.0	0.033
Beige	06474CL090	4	4.0	0.033
Light Grey	06474CL129	4	4.0	0.033
Anthracite Grey	06474CL144	4	4.0	0.033

Main drain grille

for pool standard compliance



Complies with Standards
EN 16582-1



Complies with Standards
of EN 16713-2

DESCRIPTION

Grille to replace the grilles on already installed main drains in private pools, to meet pool regulations. Made of PP plastic. Compatible with main drains 00270, 00271, 06474 and 07880.

	Code	Standard Pack	Standard weight in kg	Standard volume in m ³
Grille				
White	74097	6	3	0.033
Beige	74097CL090	6	3	0.033
Light grey	74097CL129	6	3	0.033
Anthracite grey	74097CL144	6	3	0.033

Square 210 mm x 210 mm

main drain with ABS grille



Complies with Standards
EN 16582-1

DESCRIPTION

With 2" side outlet. Body and grille in ABS. Comes with self-adhesive gaskets, flange and screws. Maximum recommended flow rate: 13 m³/h.

	Code	Standard Pack	Standard weight in kg	Standard volume in m ³
	00273	4	5.5	0.043

Liner and prefabricated pool - Main drains

Round main drain in stainless steel



Complies with Standards EN 16582-1

DESCRIPTION

2" side outlet. Made of AISI-316L stainless steel. Grille fitted using screws. Comes with gaskets, flange and screws. Maximum recommended flow rate: 13 m³/h.

	Code	Standard Pack	Standard weight in kg	Standard volume in m ³
2" side outlet"	00275	1	2.27	0.02
2" side outlet and 1½" bottom outlet connections	26197	1	4.23	0.04

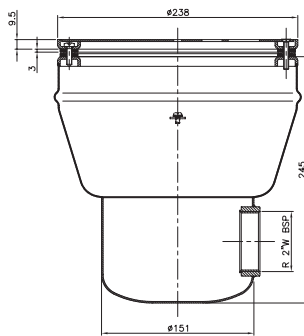

Grille for S.S. main drains for pool standard compliance



Complies with Standards EN 16582-1 EN-16713-2

DESCRIPTION

Grille to replace the grilles on already installed main drains in private pools, to meet pool regulations. Made of SS AISI-316L. Compatible with main drains 00275, 26197.

	Code	Standard Pack	Standard weight in kg	Standard volume in m ³
Antivortex main drain grille (Liner)	74808	1	-	-

Adaptor kit for main drain



DESCRIPTION

For main drain 00269. Comes with gaskets, flange and screws. Flange in AISI-316L stainless steel.

	Code	Standard Pack	Standard weight in kg	Standard volume in m ³
	00276	40	9.7	0.01

Liner and prefabricated pool - Main drains

NORM main drain

in polyester and fibreglass - 350 mm x 350 mm

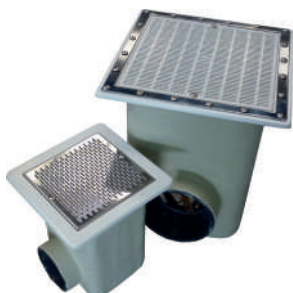

Complies with Standard
EN 13451-1-3



Complies with Standards
EN 16713-02:2016

Optional standard American
size and antivortex in
standard American size

DESCRIPTION

Range of main drains manufactured in polyester resin and fibreglass. Grille in stainless steel. Optional hydrostatic valve. Minimum depth of installation: 1.5 m. Maximum recommended flow rate down drain: 103 m³/h (0.5 m/s).

	Code	Standard Pack	Standard weight in kg	Standard volume in m ³
Outlet connection to be glued				
Flow rate				
Ø 75 mm	20074N	1	8	0.08
Ø 90 mm	20075N	1	9	0.08
Ø 110 mm	20290N	1	10	0.08

NORM main drain

in polyester and fibreglass - 507 mm x 507 mm



Complies with Standard
EN 13451-1-3



Complies with Standards
EN 16713-02:2016

Optional standard American
size and antivortex in
standard American size

DESCRIPTION

Range of main drains manufactured in polyester resin and fibreglass. Grille in stainless steel. Optional hydrostatic valve. Minimum depth of installation: 1.5 m. Maximum recommended flow rate down drain: 103 m³/h (0.5 m/s).

	Code	Standard Pack	Standard weight in kg	Standard volume in m ³
Outlet connection to be glued				
Flow rate				
Ø 110 mm	20076N	1	16	0.23
Ø 125 mm	20077N	1	17	0.23
Ø 140 mm	20078N	1	18	0.23
Ø 160 mm	20079N	1	19	0.23
Ø 200 mm	20291N	1	20	0.23

Main drain

in polyester and fibreglass - 350 mm x 350 mm



Optional:
Standard American sizes

Max. recommended flow
rate: 45 m³/h (0.5 m/s).
Recommended flow rate: 27
m³/h (0.3 m/s)

DESCRIPTION

Made of fibreglass-reinforced polyester. With a gelcoat finish. Comes with gaskets, flange and screws. Holes < 8 mm. Outlet connection to be glued. With optional hydrostatic valve.

	Code	Standard Pack	Standard weight in kg	Standard volume in m ³
Grille in stainless steel				
Outlet connection to be glued				
Flow rate				
Ø 75 mm	20074	1	6.5	0.047
Ø 90 mm	20075	1	6.5	0.047
Ø 110 mm	20290	1	6.5	0.047

Max. recommended flow rate: 33.5 m³/h (0.5 m/s). Recommended flow rate: 20 m³/h (0.3 m/s).

Grille in ABS plastic with protection against UV rays

	Code	Standard Pack	Standard weight in kg	Standard volume in m ³
Outlet connection to be glued				
Flow rate				
Ø 75 mm	22416	1	6.5	0.047
Ø 90 mm	22417	1	6.5	0.047
Ø 110 mm	22418	1	6.5	0.047
Ø 125 mm	22419	1	6.5	0.047

Liner and prefabricated pool - Main drains

Main drain in polyester and fibreglass - 507 mm x 507 mm



DESCRIPTION

With a gelcoat finish. Grille in AISI-316L stainless steel. Comes with gaskets, flanges and screws. Holes < 8 mm. Outlet connection to be glued. Recommended flow rate: 62 m³/h (0.3 m/s). Max. recommended flow rate: 103 m³/h (0.5 m/s). With optional hydrostatic valve.

		Code	Standard Pack	Standard weight in kg	Standard volume in m ³
Grille in stainless steel					
Outlet connection to be glued	Flow rate				
Ø 110 mm	42 m ³ /h	20076	1	1.4	0.132
Ø 125 mm	51 m ³ /h	20077	1	1.4	0.132
Ø 140 mm	66 m ³ /h	20078	1	1.4	0.132
Ø 160 mm	95 m ³ /h	20079	1	1.4	0.132
Ø 200 mm	103 m ³ /h	20291	1	1.4	0.132
Grille in ABS plastic with protection against UV rays					
Outlet connection to be glued	Flow rate				
Ø 110 mm	42 m ³ /h	28722	1	1.4	0.132
Ø 125 mm	51 m ³ /h	28723	1	1.4	0.132
Ø 140 mm	66 m ³ /h	28724	1	1.4	0.132
Ø 160 mm	95 m ³ /h	28725	1	1.4	0.132
Ø 200 mm	103 m ³ /h	28726	1	1.4	0.132

Liner and pref. pool - Main drain accessories

Hydrostatic valve



DESCRIPTION

To alleviate the pressure that can build up under the pool shell due to groundwater, it is recommended that a hydrostatic valve and a drainage pipe be fitted to the main drain. Hydrostatic valve to be fitted to the 2" bottom outlet on main drains. Made of white ABS, with stainless steel screw and spring. 1½" male thread.

	Code	Standard Pack	Standard weight in kg	Standard volume in m ³
	00277	50	2.63	0.01

Drainage pipe

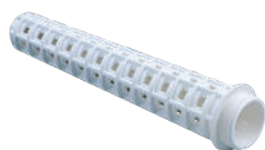

DESCRIPTION

Drainage tube with 1½" BSP thread connection for drains 00270 (see page 123), 27838 (see page 123), 26197 (see page 125) y 27125 (see page 123). Manufactured in ABS.

	Code	Standard Pack	Standard weight in kg	Standard volume in m ³
	21581	24	3.54	0.021

Liner and prefabricated pool - Main Drain accessories

Flush-fit antivortex cover



DESCRIPTION

Special flush-fit design that enables pool cleaners to go over it without blocking it up.

The 415 mm x 415 mm cover (25344) can be fitted to the following main drains:

With stainless steel grille: **With plastic grille:**

- 20074 -22416
- 20075 -22417
- 20290 -22418
- 22419

The 570 mm x 570 mm cover (28556) can be fitted to the following main drains:

With stainless steel grille: **With plastic grille:**

- 20076 -28722
- 20077 -28723
- 20078 -28724
- 20079 -28725

	Code	Standard Pack	Standard weight in kg	Standard volume in m ³
415 mm x 415 mm, Height: 70 mm	25344	1	2.25	0.012
570 mm x 570 mm, Height: 60 mm	28556	1	3.90	0.015



Complies with Standard EN 13451-1:2000



Complies with Standards EN 16713-02:2016

Liner and pref. pool - Level regulators

Level regulator



DESCRIPTION

Made of ABS. May be connected from the bottom or side, as required. Semi-die cut outlets to the pool so that the most suitable connection can be made. Adjustable lid height and level. For all types of skimmers. Cover color can be changed using the 15L skimmers covers: 00249-0700CL090, 00249-0700CL129, 00249-0700CL144 from page 119.

	Code	Standard Pack	Standard weight in kg	Standard volume in m ³
	15862	1	2.0	0.016

Level regulating valve



DESCRIPTION

Level regulator valve compatible with the stainless steel skimmers of SLIM range. Compatible with items: 56313, 56316, 72743, 72744, 73501 73502. With 3/8" side connection and adjustable floater.

	Code	Standard Pack	Standard weight in kg	Standard volume in m ³
	73453	1	0.9	0.008

Liner and prefabricated pool - Inlets

Multiflow system

- The inlet's eyeball is supplied pre-marked with a number of diameters (14-20 and 25). With the help of a punch (also supplied with the inlet) one of the diameters can be cut out at the time of installation.
- Max. recommended flow rate for a max. flow of 4 m/s:
 \varnothing 14 mm = 2.2 m³/h, \varnothing 20 mm = 4.5 m³/h, \varnothing 25 mm = 7 m³/h

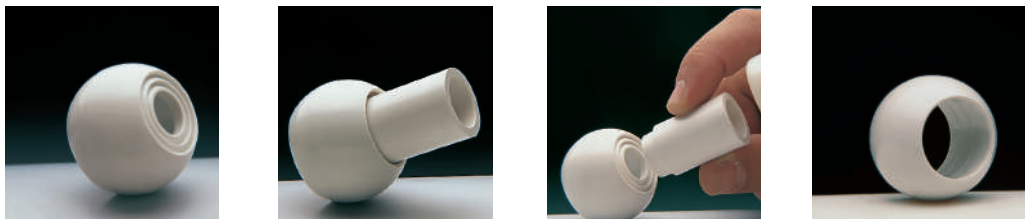

Multiflow threaded return inlet for liner pools



DESCRIPTION

Outer 2" thread, \varnothing 50mm inner. For liner pools. Comes in ABS, with gaskets and screws. Installation with bushing 15662 or 15663 is recommended (see page 140).

	Code	Standard Pack	Standard weight in kg	Standard volume in m ³
White	00330	12	4.5	0.020
Beige	00330CL090	12	4.5	0.020
Light Grey	00330CL129	12	4.5	0.020
Anthracite Grey	00330CL144	12	4.5	0.020

NORM return inlets



DESCRIPTION

Range of inlets suitable for installation in public and private pools. Manufactured in ABS with UV treatment.

	Code	Standard Pack	Standard weight in kg	Standard volume in m ³
For prefabricated/liner pools				
White	56499	12	4.5	0.020
Beige	56499CL090	12	4.5	0.020
Light Grey	56499CL129	12	4.5	0.020
Anthracite Grey	56499CL144	12	4.5	0.020
For prefabricated pools				
White	56500	24	4.5	0.020
Beige	56500CL090	24	4.5	0.020
Light Grey	56500CL129	24	4.5	0.020
Anthracite Grey	56500CL144	24	4.5	0.020

Liner and prefabricated pool - Inlets

Return inlets



DESCRIPTION

Range of inlets suitable for installation in public and private pools. Manufactured in ABS with UV treatment.

	Code	Standard Pack	Standard weight in kg	Standard volume in m ³
For prefabricated pools, Parker				
White	17383	24	4.5	0.020
Beige	17383CL090	24	4.5	0.020
Light Grey	17383CL129	24	4.5	0.020
Anthracite Grey	17383CL144	24	4.5	0.020



Complies with Standards
EN 16582-1
EN 16713-2

Multiflow threaded return inlet

Parker model



DESCRIPTION

2" external thread, Ø 50 mm inner wall with Parker system. (Self-tapping screws). For installation with wall conduits code 15664 or 15665 (see page 140).

	Code	Standard Pack	Standard weight in kg	Standard volume in m ³
	06498	20	4.72	0.021



Complies with Standards
EN 16582-1
EN 16713-2

Multiflow threaded return inlet



DESCRIPTION

Outer 2" thread and Ø 50 mm inner wall to be glued. Made of ABS.

	Code	Standard Pack	Standard weight in kg	Standard volume in m ³
White	00334	24	4.61	0.020
Beige	00334CL090	24	4.61	0.020
Light Grey	00334CL129	24	4.61	0.020
Anthracite Grey	00334CL144	24	4.61	0.020



Complies with Standards
EN 16582-1
EN 16713-2

Liner and prefabricated pool - Inlets

Multiflow threaded return inlet



DESCRIPTION

2" outer thread, 1½" inner thread. Made of white ABS. Comes with gaskets. The slots in the grille are no larger than 8 mm.



	Code	Standard Pack	Standard weight in kg	Standard volume in m ³
Standard inlet	06481	30	5.1	0.021

Multiflow return inlet for panel pools



DESCRIPTION

Inlets specially designed for installation in panel pools between 10 and 15 cm thick. To be glued to a Ø 50 mm pipe. Made of white ABS. Comes with gaskets.



	Code	Standard Pack	Standard weight in kg	Standard volume in m ³
	33091	8	3.35	0.021

Return nozzle for prefabricated pools with liner



DESCRIPTION

The diameter of the outer wall has a smaller diameter than other models so that it fits better in curved walls.



	Code	Standard Pack	Standard weight in kg	Standard volume in m ³
Threaded 1½" BSP return nozzle	32450	24	7.1	0.021

Adjustable return inlet



DESCRIPTION

Comes with gaskets, flange and screws. 3 adjustable positions: (100%, 65%, 35%). Flow rate: 13.5 m³/h. Outer Ø 63 mm connection.



	Code	Standard Pack	Standard weight in kg	Standard volume in m ³
	15864	12	4.2	0.02

Liner and prefabricated pool - Inlets

Inlet base



DESCRIPTION

Kit Base and nut - Connection to the base Ø50 mm, 2"nut.

	Code	Standard Pack	Standard weight in kg	Standard volume in m ³
Inlet body set+nut	74179	24 u	4,61	0,021

Multiflow return inlet for prefabricated pools



	Code	Standard Pack	Standard weight in kg	Standard volume in m ³
	00338	18 u	5,7	0,021

Pool floor return inlet for prefabricated pools



DESCRIPTION

Return nozzle. Comes with gaskets, flanges and screws. Adjustable flow rate. Max. flow rate: 12 m³/h.

	Code	Standard Pack	Standard weight in kg	Standard volume in m ³
2" outer thread and internal Ø 50 mm				
White	00340	12	5,4	0,020
Beige	00340CL090	12	5,4	0,020
Light Grey	00340CL129	12	5,4	0,020
Anthracite Grey	00340CL144	12	5,4	0,020

To be glued Ø 63 mm PN 6 outer wall, Ø 50 mm inner

White	20139	12	5,4	0,021
-------	-------	----	-----	-------



Complies with Standards
EN 16582-1
EN 16713-2

BCN03 pool floor return inlet



DESCRIPTION

Adjustable pool floor return inlet for liner pools. Designed to be glued to the inside of PN6 and PN10 piping. Made of white ABS, with self-tapping screws or with metal inserts. Plastic or stainless steel flange, depending on the model. Maximum flow rate: 9.5 m³/h.

	Code	Standard Pack	Standard weight in kg	Standard volume in m ³
PN6, with self-screw	28230	12	3,25	0,031
PN6, with inserts	28231	12	3,55	0,031
PN10, with inserts and stainless steel flange	28502	12	4,54	0,031



Complies with Standards
EN 16582-1
EN 16713-2

Liner and prefabricated pool - Inlets

BCN03 adjustable pool floor

return inlet



DESCRIPTION

Pool floor return inlet for liner pools. Thanks to the adjustable feature, its installation in the pool floor is made extremely easy as it can be fitted after the concrete has been laid with wall conduit 43590.

	Code	Standard Pack	Standard weight in kg	Standard volume in m ³
With plastic flange inserts	43586	12	2.04	0.033
Plastic self-tapping flange	43587	12	2.04	0.033
With stainless steel flange inserts	43588	12	2.04	0.033
Self-tapping stainless steel flange	43589	12	2.04	0.033

Ø 90 mm wall conduit



DESCRIPTION

PVC wall conduit. Cutting area of 120 mm for fitting it to the pool wall or floor. Ø 63 or Ø 75 connection, as required.

For inlets:

Net'N'Clean: 43584

BCN 03: 43586 - 43587 - 43588 - 43589

Return inlet/suction nozzle for high flow rates: 41518 - 41519 - 41520 - 41521

	Code	Standard Pack	Standard weight in kg	Standard volume in m ³
Ø 90/Ø 63-Ø 75 mm wall conduit	43590	9	7.3	0.033

3" adjustable pool floor

return inlet



DESCRIPTION

Made of white ABS. Suction. Comes with gaskets, flanges and screws. Flow rate adjusted by turning the grille. Suction surface area: 0.015 m². Flow rate at 0.4 m/s: 20 m³/h. Max. recommended flow rate: 26 m³/h. (0.5 m/s).

	Code	Standard Pack	Standard weight in kg	Standard volume in m ³
Grille in AISI-304 Stainless Steel	08316	2	2.65	0.047
Grille in white ABS	11795	2	2.65	0.047

Suction nozzle

for prefabricated pools



DESCRIPTION

Outer 2" thread, internal Ø 50 mm. Made of white ABS. Comes with plug, gaskets and screws. Recommended for installation with wall conduit 15663.

	Code	Standard Pack	Standard weight in kg	Standard volume in m ³
Standard return inlet				
White	00332	12	4.22	0.020
Beige	00332CL090	12	5.4	0.020
Light Grey	00332CL129	12	5.4	0.020
Anthracite Grey	00332CL144	12	5.4	0.020



00332



00332CL090



00332CL129



00332CL144



Liner and prefabricated pool - Inlets



Suction nozzle

for panel pools



DESCRIPTION

For installation in panel pools between 10 and 15 cm thick. Comes with gaskets. Connections: To be glued to Ø 50 mm piping and 1½" BSP thread.



Complies with Standards
EN 16582-1
EN 16713-2

Code	Standard Pack	Standard weight in kg	Standard volume in m³
33092	8	3.35	0.021

Return nozzle

for liner pools



DESCRIPTION

Made of ABS. Comes with gaskets, flanges and screws. Connections: outer 2" thread and Ø 50 mm inner.



Complies with Standards
EN 16582-1
EN 16713-2

Code	Standard Pack	Standard weight in kg	Standard volume in m³
17382	20	6.0	0.020
17382CL090	20	6.0	0.020
17382CL129	20	6.0	0.020
17382CL144	20	6.0	0.020

Suction nozzle



DESCRIPTION

Outer 2" thread, Ø 50 mm inner wall. For prefabricated pools. Made of ABS. Comes with 1½" threaded plug.

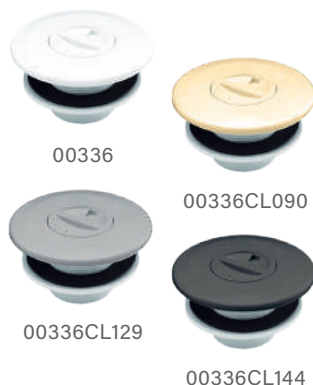

Complies with Standards
EN 16582-1
EN 16713-2

Code	Standard Pack	Standard weight in kg	Standard volume in m³
00336	24	4.13	0.020
00336CL090	24	4.13	0.020
00336CL129	24	4.13	0.020
00336CL144	24	4.13	0.020

Liner and prefabricated pool - Inlets

Double gasket kit



DESCRIPTION

Kit made up of a double gasket and the screws necessary for the installation of nozzles in panel pools. Made of TPE, the kit enables the installation of various accessories in pool shells and protects the panelling from coming into contact with water. Easy to install. Prevents corrosion of the panelling in the area that has been die cut.

We recommend to place this Kit on panel pools of metal sheet in nozzles 00330; 00332; 17382; 17383 and 56499.

	Code	Standard Pack	Standard weight in kg	Standard volume in m ³
Inserts for nozzles	43455-0500	80	-	0.035

Return inlet/suction nozzle for high flow rates



DESCRIPTION

Return inlet for large flow rates that can also be used as a suction nozzle. Maximum suction flow rate of 30m³/h for a maximum flow rate speed of 4 m/s. Maximum suction flow rate of 5 m³/h for a maximum flow rate speed of 0.5 m/s. PVC body. Connection for Ø 75 or Ø 90 mm pipe. Inlets can be installed into bushing 43590 (see page 133). Grille can be adjusted in any direction.



	Code	Standard Pack	Standard weight in kg	Standard volume in m ³
Panel pools	41518	10	5.50	0.021
Prefabricated pools	41521	12	4.20	0.021

Return nozzle



DESCRIPTION

2" outer thread, 1½" inner thread. Made of white ABS.



	Code	Standard Pack	Standard weight in kg	Standard volume in m ³
Standard inlet	06484	30	4.3	0.021

Liner and prefabricated pool - Inlets

Lateral nozzle



DESCRIPTION

Specially designed for polyester pools. Main-drain / nozzle that should be installed in the wall of the pool in the deepest area of the pool. Installation with 2" thread, gasket and nut. Made of ABS. Flow rate : 6m³/h.

	Code	Standard Pack	Standard weight in kg	Standard volume in m ³
White	74121	24	4.5	0.021
Beige	74121CL090	24	4.5	0.021
Light Grey	74121CL129	24	4.5	0.021
Anthracite grey	74121CL144	24	4.5	0.021

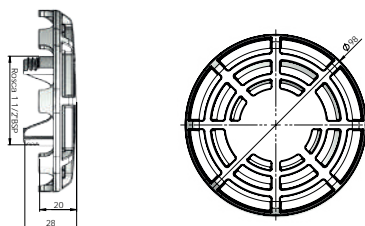

Hydromassage kit



DESCRIPTION

Made up of a return inlet and wall conduit fitted with an air inlet and a venturi. Two wall conduit lengths available. Ø 50 mm water connection pipe and Ø 20 mm air suction pipe.

	Code	Standard Pack	Standard weight in kg	Standard volume in m ³
Hydromassage kit for prefabricated polyester pools:				
Length of wall conduit 190 mm				
White	32114	12	3.5	0.021
Beige	32114CL090	12	3.5	0.021
Light grey	32114CL129	12	3.5	0.021
Anthracite Grey	32114CL144	12	3.5	0.021
Length of wall conduit 275 mm				
White	32384	10	3.4	0.021
Beige	32384CL090	10	3.4	0.021
Light grey	32384CL129	10	3.4	0.021
Anthracite Grey	32384CL144	10	3.4	0.021
Hydromassage kit for prefabricated pools with liner:				
Length of wall conduit 190 mm				
White	32115	12	3.5	0.021
Beige	32115CL090	12	3.5	0.021
Light grey	32115CL129	12	3.5	0.021
Anthracite Grey	32115CL144	12	3.5	0.021
Length of wall conduit 275 mm				
White	32385	8	3.5	0.021
Beige	32385CL090	8	3.5	0.021
Light grey	32385CL129	8	3.5	0.021
Anthracite Grey	32385CL144	8	3.5	0.021

Adjustable air impulsion inlet



DESCRIPTION

For air distribution by means of the blowers. Maximum flow rate 18 m³/h.

	Code	Standard Pack	Standard weight in kg	Standard volume in m ³
	49818	12	4.24	0.021



Liner and prefabricated pool - Stainless Steel Inlets



Return inlet with Ø 20mm ball for liner pool



DESCRIPTION

1½" external thread. Manufactured in AISI-316L stainless steel. Ø 20 mm ball. Comes with gaskets and screws. Maximum recommended flow of 4.5 m³/hour according to EN 16582-1 and EN16713-2 standards if installed at a maximum of 500 mm below pool water level.

Code	Standard Pack	Standard weight in kg	Standard volume in m³
16327	1	0.5	0.001



Return inlet with Ø 25 mm ball for liner pool

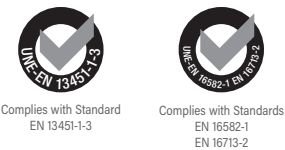

DESCRIPTION

1½" external thread. Manufactured in AISI-316L stainless steel. Ø 25 mm ball. Comes with gaskets and screws. Recommended flow rate: 7 m³/h.

Code	Standard Pack	Standard weight in kg	Standard volume in m³
69877	1	0.5	0.001



Adapter for pool wall conduits

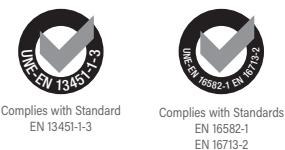

DESCRIPTION

1½" external thread. Manufactured in AISI-316L stainless steel. For adapting concrete pool bushings to prefabricated pool ones. Must be used with stainless steel inlet 16331, 69878.

Code	Standard Pack	Standard weight in kg	Standard volume in m³
26171	1	0.2	0.001



Bushing return inlet with Ø20 ball for liner pool



DESCRIPTION

Manufactured in AISI-316L stainless steel. Fits to 00344 and 00345 bushings and adapts to converter 26171. Comes with gaskets and screws. Install at a maximum of 500 mm below water level. Ball fitted using screws. Recommended flow rate: 4.5 m³/h.

Code	Standard Pack	Standard weight in kg	Standard volume in m³
16331	1	0.3	0.001

Liner and prefabricated pool - Stainless Steel Inlets

Bushing return inlet with Ø25 ball for liner pool



DESCRIPTION

Manufactured in AISI-316L stainless steel. Fits to 00344 and 00345 bushings and adapts to converter 26171. Comes with gaskets and screws. Ball fitted using screws. Recommended flow rate: 7 m³/h.



Complies with Standard
EN 13451-1-3



Complies with Standards
EN 16582-1
EN 16713-2

Code	Standard Pack	Standard weight in kg	Standard volume in m³
69878	1	0.3	0.001

Adjustable pool floor return inlet



DESCRIPTION

2" external thread. Made of AISI-316L stainless steel. Can be fitted in concrete and prefabricated pools. The water flow can be adjusted by loosening or tightening the central screw. Max. recommended flow rate complaint with standard EN 13451-3: 14 m³/h.



Complies with Standard
EN 13451-1-3



Complies with Standards
EN 16582-1
EN 16713-2

Code	Standard Pack	Standard weight in kg	Standard volume in m³
15839	1	0.9	0.002

Suction nozzle for liner pools



DESCRIPTION

In AISI-316L stainless steel. Comes with sealing gaskets, flange and screws. With 1½" outer thread. Push-fit connection 06584 is needed.



Complies with Standard
EN 13451-1-3



Complies with Standards
EN 16582-1
EN 16713-2

Code	Standard Pack	Standard weight in kg	Standard volume in m³
16330	1	0.5	0.001

Liner and pref. pool - Stainless Steel Embellishers for ABS

Stainless Steel embellisher for Skimmers



DESCRIPTION

AISI-316L embellishers for ABS skimmers. Includes flange, screws and gaskets.

	Code	Standard Pack	Standard weight in kg	Standard volume in m ³
ABS standard mouth skimmers items 01461 (15L), 01462 (15L), 11309 (17.5L), 11310 (17.5L)	56344	1	1.5	0.004
ABS wide mouth skimmers items 01463 (15L), 01464 (15L), 11311 (17.5L), 11313 (17.5L)	56340	1	1.87	0.005
ABS skimmer NORM item 56176	74101	1	1.76	0.001



Stainless Steel embellisher for main drain



DESCRIPTION

AISI-316L embellishers for ABS main drains. It includes screws.

	Code	Standard Pack	Standard weight in kg	Standard volume in m ³
ABS main drain 00270	69173	1	1.44	0.001
ABS main drain 00271	69174	1	1.21	0.003



Stainless Steel embellisher for inlets



DESCRIPTION

AISI-316L embellishers for ABS inlets. Includes flange, screws and gaskets.

	Code	Standard Pack	Standard weight in kg	Standard volume in m ³
Compatible with: ABS return inlet items 00330 and 56499	69171	1	0.31	0.001
ABS suction inlet item 00332	69172	1	0.41	0.001
ABS return inlet code 56499 and 00330	74525	1	0.38	0.001



Liner and prefabricated pool - Wall bushings

Wall conduits in ABS



DESCRIPTION

Range of 300 mm long conduits for Ø 2" inlets and Multiflow that can be cut to different lengths, depending on the thickness of the pool wall. Made of ABS. The ribs of the end plates have holes for fitting the wall conduit to the pool structure, which makes assembly straightforward. The inlet's end plate ensures that it fits flush to the pool wall so that the liner remains flat against the wall and does not swell. This system is aesthetically pleasing as only the face plate can be seen.

	Code	Standard Pack	Standard weight in kg	Standard volume in m ³
Wall conduit with 2" rear male thread and Ø 50 mm smooth inner wall				
2" front female thread for nozzles with 2" male thread	15663	12	4.0	0.040
2" front female thread for nozzle with code number 06498 only	15664	14	4.2	0.040
Wall conduit with smooth Ø 63 mm rear connection and smooth Ø 50 mm inner wall				
2" front female thread for nozzles with 2" male thread	15662	12	5.0	0.040
2" front female thread for nozzle 06498 only	15665	14	5.4	0.040

Wall conduits in PVC



	Code	Standard Pack	Standard weight in kg	Standard volume in m ³
Grey PVC. 150 mm long				
2" outer thread + Ø 50 mm inner, 2" inner thread	00322	40	8.2	0.040
Grey PVC. 300 mm long				
2" female and male thread connection	00323	20	8.9	0.040
2" rear male thread pipe connection or smooth inner wall for MINI projector (33684)	00324	20	8.5	0.040
2" outer thread + Ø 50 mm inner, 1½" inner thread	00325	20	8.4	0.040
2" outer thread + Ø 50 mm inner wall. Ø 50 mm inner wall specially for nozzles with code numbers 00289, 07957, 00304, 00305 and 00306	00326	20	8.4	0.040

Wall conduits in Stainless Steel



DESCRIPTION

Made in stainless steel. AISI-304L. Both ends have a 1½" female thread. With an equipotential outlet. For inlet 16331 (see page 138).

	Code	Standard Pack	Standard weight in kg	Standard volume in m ³
Length 240 mm	00344	1	0.7	0.003
Length 340 mm	00345	1	0.9	0.005

Liner and pref. pool - Floating skimmer



Floating skimmer



DESCRIPTION

Diameter 160 mm. Maximum flow rate: 5 m³/h. Ø 32 mm and Ø 38 mm outer connections. With plastic support clamp designed for panel pools.

	Code	Standard Pack	Standard weight in kg	Standard volume in m ³
	16573	1	1.3	0.024

Pool shell equipment packs

Pool shell equipment packs



DESCRIPTION

Pack made up of: 2 skimmers, 3 multifold return inlets, 1 suction nozzle, 1 round main drain.

	Code	Standard Pack	Standard weight in kg	Standard volume in m ³
Pack for concrete pools	74349	1	5.20	0.074
Pack for liner pools	74350	1	10.78	0.158

Pack for concrete pools Contains the following products:				
	00249 x 2	56379 x 1	24413 x 3	24415 x 1
Pack for liner pools Contains the following products:				
	01464 x 2	56382 x 1	56381 x 3	00332 x 1

Liner and pref. pool - Interchangeable accessories

Interchangeable

pool basin equipment

DESCRIPTION

Bushing, return inlet, suction nozzle, flange assembly to be installed in concrete, prefabricated and liner pools. The measurements of each item make it possible to interchange them with the stainless steel sets. The inlets can be installed in any bushing with a 1½" BSP thread. There is a flange set to install the inlets in pools with a liner. All items mainly made in plastic (ABS), except screws and gaskets. Each item can be assembled with the stainless steel sets. Interchangeable stainless steel/plastic codes.

	Code	Standard Pack	Standard weight in kg	Standard volume in m³
S. S. interchangeable return inlet	49758	1	0.33	0.021
ABS interchangeable return inlet				
White	49754	50 u	4.84	0.021
Beige	49754CL090	50 u	4.84	0.021
Light grey	49754CL129	50 u	4.84	0.021
Anthracite grey	49754CL144	50 u	4.84	0.021
ABS interchangeable return inlet circular vent	52681	50	4.84	0.021
Stainless Steel interchangeable suction nozzle	49759	1	0.16	0.021
ABS interchangeable suction nozzle				
White	72672	50 u	4.84	0.021
Beige	72672CL090	50 u	4.84	0.021
Light grey	72672CL129	50 u	4.84	0.021
Anthracite grey	72672CL144	50 u	4.84	0.021
S. S. interchangeable flange inlet set	49760	1	0.16	0.021
ABS interchangeable flange inlet set	49756	50 u	4.84	0.021
Interchangeable bushing inlet set S. S. for threading	49761	1	0.70	0.021
Interchangeable bushing inlet set ABS for threading	49757	9	2.93	0.021
Interchangeable bushing inlet set ABS for gluing	49832	9	2.93	0.021

				
	Return nozzle	Suction nozzle	Flange	Wall conduits
Stainless Steel	49758	49759	49760	49761
ABS	49754 52681*	72672	49756	49757 49832**

* Circular vent ** To glue

Installation diagrams

INSTALLATION DIAGRAMS

Skimmer installation

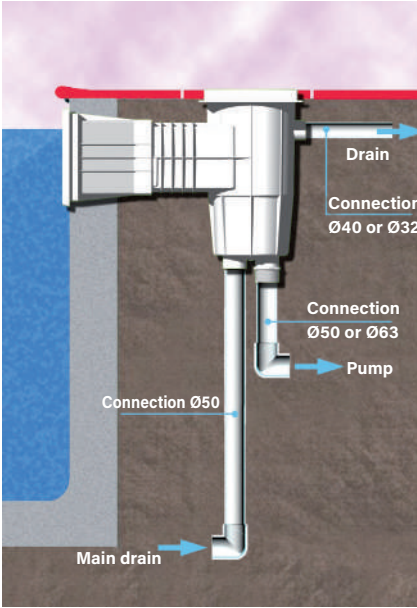

Water level regulator installation

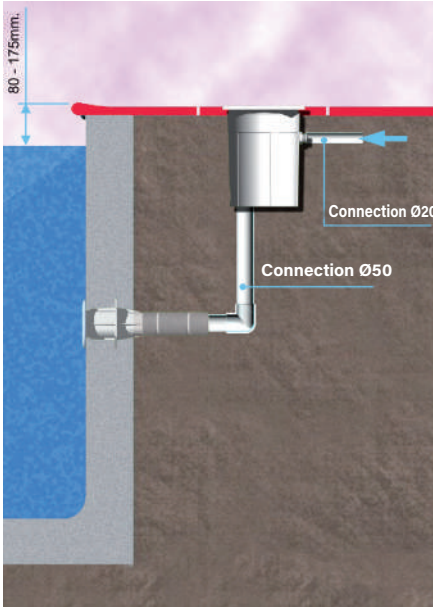

Main drain installation

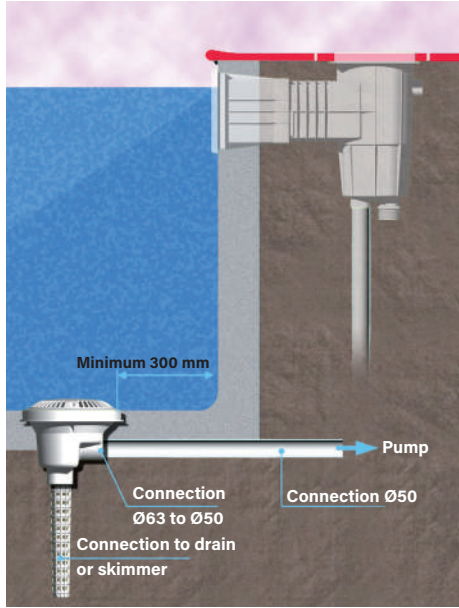

Nozzle installation

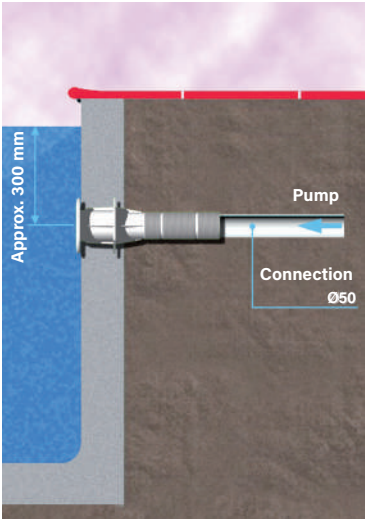

Underwater installation

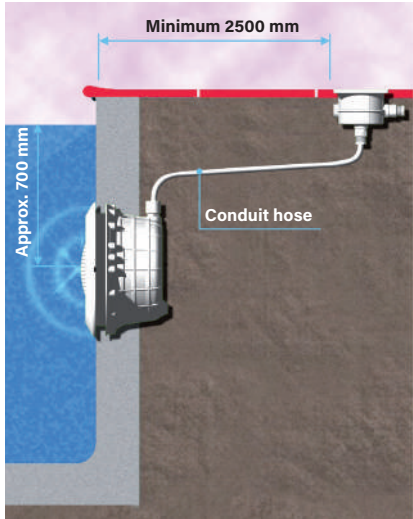

Net'n'Clean valve installation

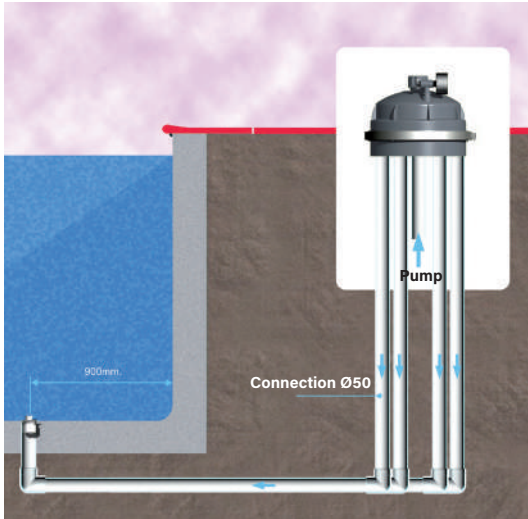

Spa installation

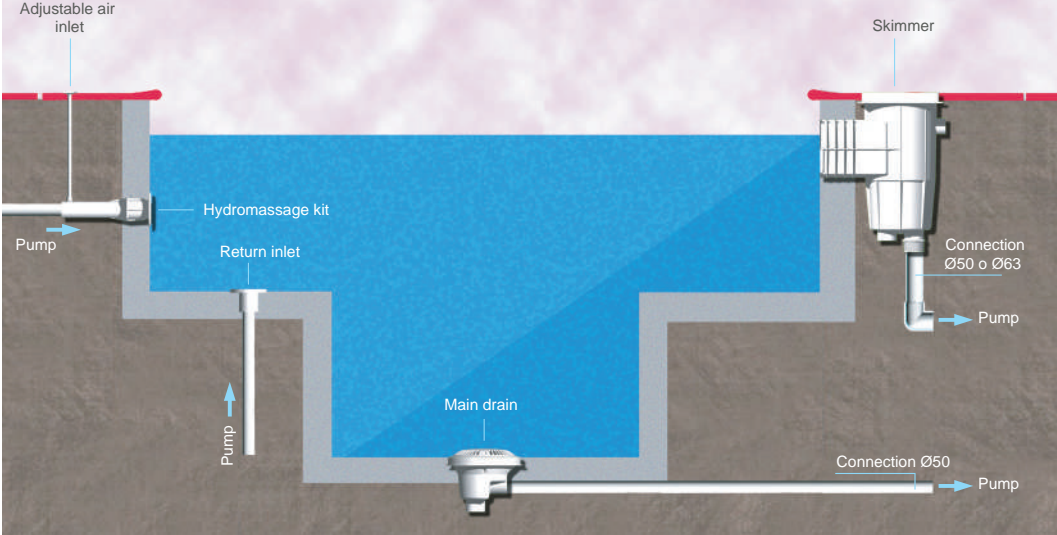

Installation diagrams

INSTALLATION DIAGRAMS

CONCRETE POOLS:

Concrete / liner

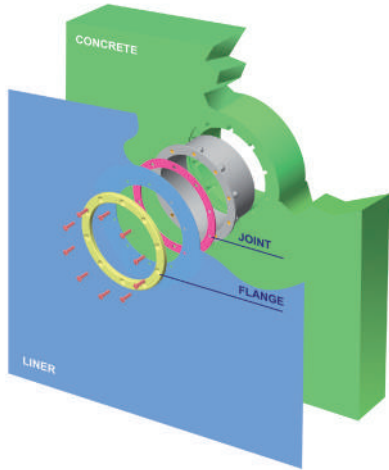

Concrete

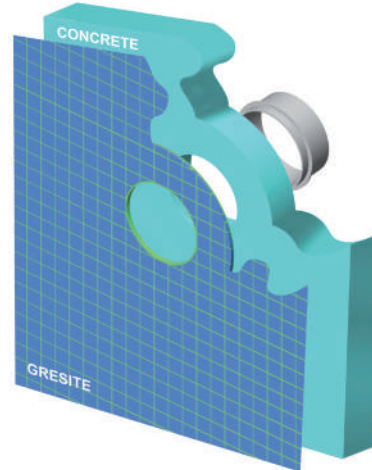

FIBREGLASS POOLS:

Fibreglass

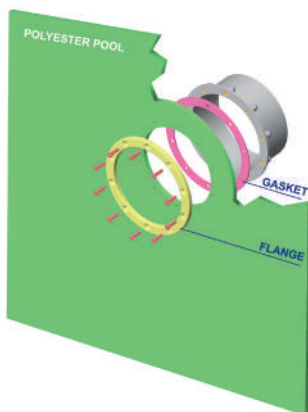

Threaded fibreglass

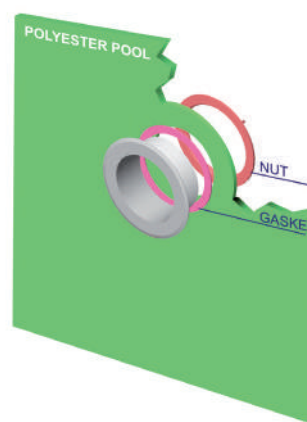

PANEL POOLS:

1 gasket

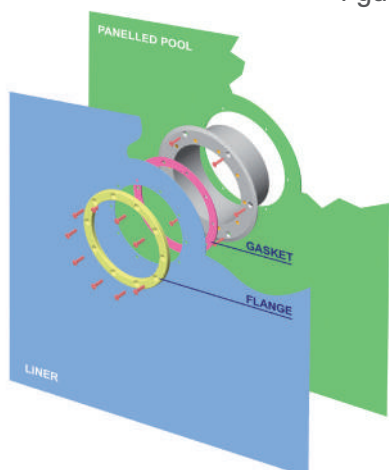

2 gaskets

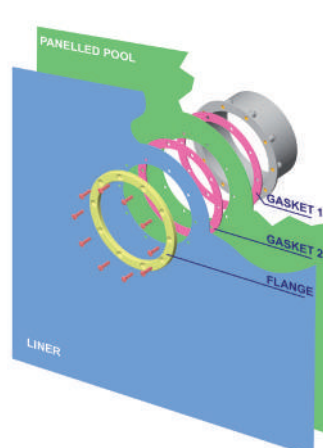



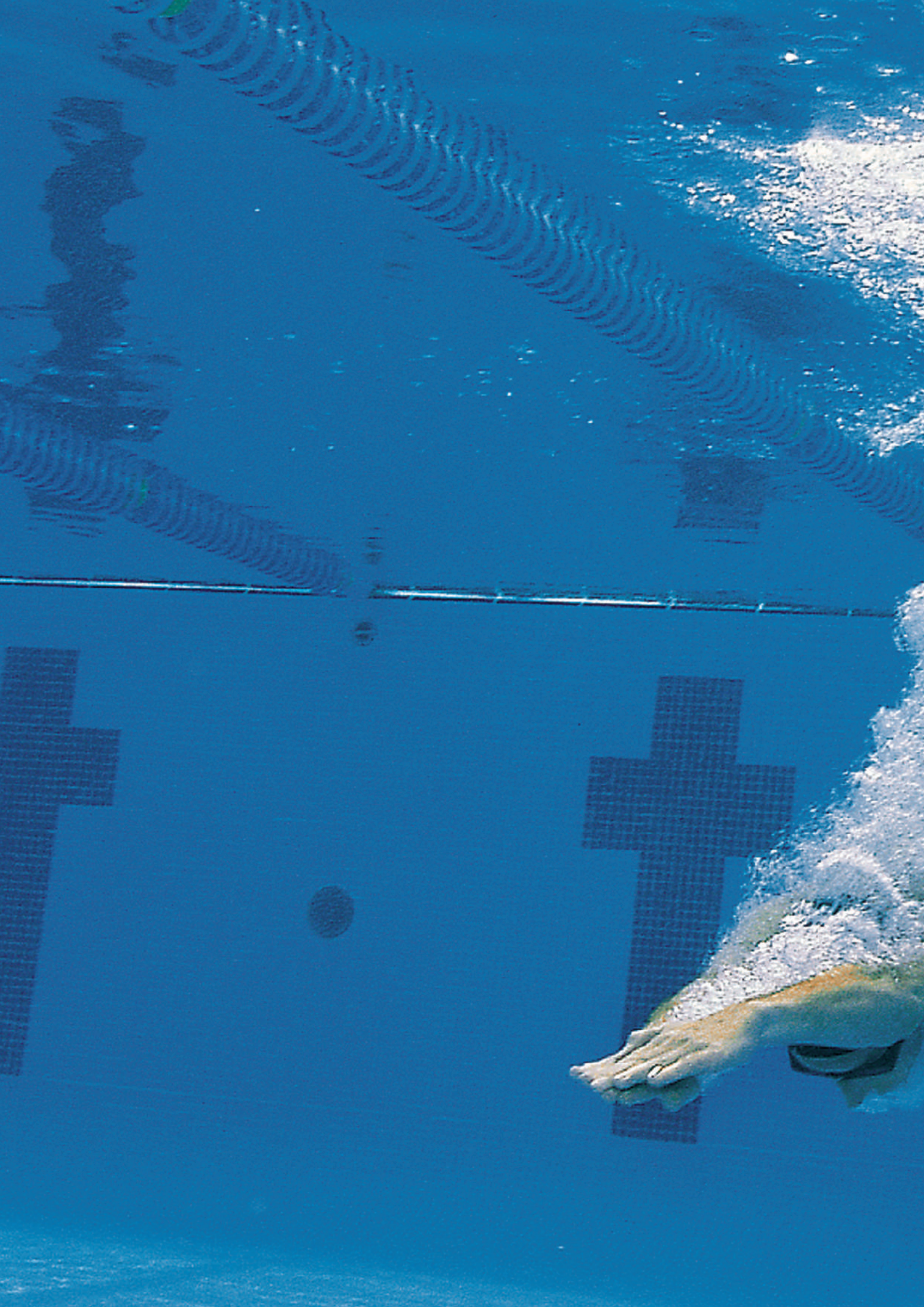

FILTRATION



148	FILTER FEATURES AND SELECTION	159	Aster filter
		160	Vesubio filter
150	NANOFIBER FILTER	161	HIGH-PERFORMANCE LAMINATED SAND FILTERS
151	DIATOMACEOUS FILTERS	161	Norma filter
151	Clarity filter	162	Delta 1200 & Delta 1000 filters
151	Diatomaceous earth	165	Artic Plus & Artic filters
152	CARTRIDGE FILTERS	167	Aster high performance filters
152	Viron cartridge filter	168	BOBBIN-WOUND SAND FILTERS
152	PRE-FILTERS	168	Berlin filter
152	Hydrospin & Hydrospin Compact	169	MONOBLOCKS
153	OC-1 FILTERS	169	Galactic
153	Aster OC-1 filter	170	SkyPool
154	INJECTION MOULDED SAND FILTERS	171	COMPACTS WITH INTERIOR INSTALLATION
154	Cantabric filter	171	Ramses in-ground compact
155	BLOW-MOULDED SAND FILTERS	171	Keops in-ground compact
155	Millennium filter	172	Ramses Up above ground compact
156	LAMINATED SAND FILTERS	172	COMPACTS WITHOUT INTERIOR INSTALLATION
156	Atlas filter	173	MULTIPORT VALVES
157	Europe Pro - Pro Long filters	180	FILTRATION MEDIA AND ACCESSORIES
158	RapidPool filter		

FILTER SELECTION GUIDE

HOW DO YOU SELECT THE FILTER THAT YOU NEED?

A key factor in cleaning pool water is its passage through the filter. This process works in a fully closed circuit. The quality and type of filter are therefore two decisive aspects so that when the water circulates through the system it comes out completely clear.

A filter should be selected based on the following criteria:

1. Type of filter medium. This is a basic decision for setting the level of water clarity, characteristics of use and maintenance.

2. Tank manufacture technology.

This directly affects its resistance, durability and quality of finish.

3. Flow rate (m³/h). Set according to the volume and recirculation time of each pool. Ensure that this matches the recommended flow rate when selecting the pump.

4. Features and added extras.

Remember to always check the space available in your facility to both access and run the filter once selected.



Aster Filter

THERE ARE 3 MAIN TYPES OF FILTER

DIATOMACEOUS EARTH FILTERS

Filtration method that delivers maximum filtration fineness. However, this system requires more time for maintenance.

- Excellent filtration quality
- Compact solution
- Expert installation and maintenance

CARTRIDGE FILTERS

One or more cartridges are used to deliver a high level of filtration fineness. This is also the ideal solution when there are restrictions on space, water consumption and water for filter backwashing.

- Very good filtration quality
- Low water consumption
- Compact solution

MEDIA FILTERS

Commonly called **sand filters**, as this is the most widely used filter medium in this type of filter. Other media can be used, such as glass and anthracite, which optimize their performance.

To obtain maximum filtration quality and performance, use filters with the highest filter bed, several layers of filter media and a low filtration speed.

- Robust technology with a great capacity for recovering unkempt water
- Easy to use and maintain
- Value for money

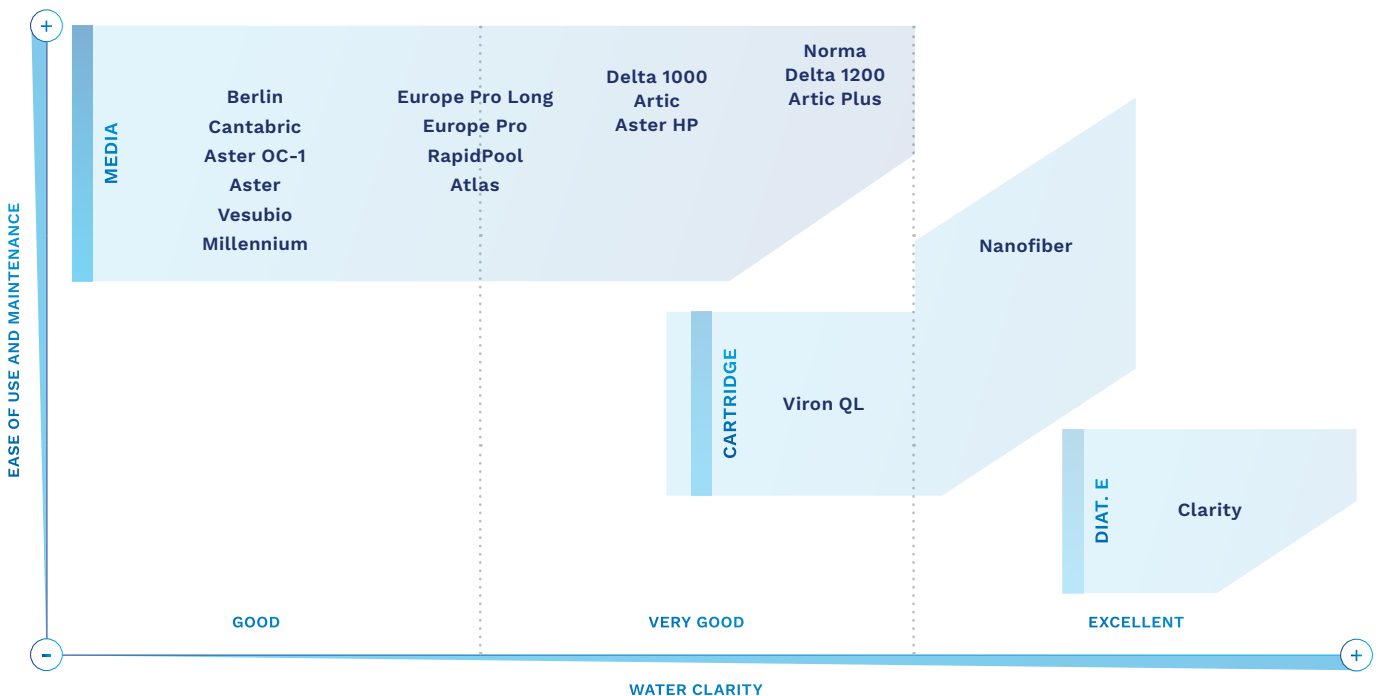

FILTER FEATURES AND SELECTION

FILTER		TANK	PRODUCT FEATURES							
		Material and technology	Rob. & durab.*	Flow m ³ /h	Diameter	Filtration quality	Connections	Warranty (t/c)**	Other	
DIAT. E		Clarity	Polyester + FG Laminated	5	11-27	610	5	1½"-2" Lateral	2/2	Excellent filtration quality. Durability and reliability of body and components.
	CARTRIDGE		Nanofiber	Injection-molded thermoplastic	3	10-18	402	5	2" Lateral	5/2
		Viron QL	Injection-molded thermoplastic	3	< 30	690	4	D50	5/2	Multi-cartridge filter. Long period between each cleaning of cartridges.
BED OF MEDIA		Cantabric	Injection-molded thermoplastic	4	6-30	400-900	2	1½"-2½" Lateral/ Top	10/2	A flagship in filtration for residential pools. High quality and design for good performance over time.
		Berlin	Polyester + FG Bobbin-wound	6	9-56	500-1,200	2	1½"-D90 Lateral	2/2	Extraordinary reliability and durability due to its dual-layer body. Large cover in diameter to facilitate access.
		Norma	Polyester + FG Laminated	5	10-34	650-1,200	4	D75-D140 Lateral	2/2	High performance in residential pools. Filter bed height of 1.2 m. Wide range of added extras and accessories.
		Delta 1200	Polyester + FG Laminated	5	13-45	650-1,200	4	1½"-D90 Lateral	2/2	High performance in residential pools. Filter bed height of 1.2 m. Wide range of added extras and accessories.
		Artic Plus	Polyester + FG Laminated	5	16-56	650-1,200	4	1½"-4" Lateral	2/2	High performance in residential pools. Filter bed height of 1.2 m. Wide range of added extras and accessories.
		Delta 1000	Polyester + FG Laminated	5	8-45	500-1,200	4	1½"-D90 Lateral	2/2	High performance in residential pools. Filter bed height of 1.0m. Wide range of added extras and accessories.
		Artic	Polyester + FG Laminated	5	9-56	500-1,200	4	1½"-4" Lateral	2/2	High performance in residential pools. Filter bed height of 1.0m. Wide range of added extras and accessories.
		Aster HP	Polyester + FG Laminated	5	9-31	500-900	4	1½"-2½" Lateral	2/2	Filter bed height of 0.8 m in all models with collector arms. Filter bed height of 0.6m in all models with nozzle plates.
		Atlas	Polyester + FG Laminated	6	9-30	500-900	3	1½"-2½" Lateral	10/2	Top quality and features in its category. Filter designed for the most exacting professionals.
		Europe Pro Long	Polyester + FG Laminated	5	9-30	500-900	3	1½"-2½" Lateral	2/2	Easy to access thanks to its large cover in diameter. Transparent or polyester cover as options.
		Europe Pro	Polyester + FG Laminated	5	9-30	500-900	3	1½"-2½" Lateral	2/2	Easy to access thanks to its large cover in diameter. Transparent or polyester cover as options.
		RapidPool	Polyester + FG Laminated	5	6-24	400-800	5	1½"-2" Lateral	2/2	Rapid access cover. No need for tools to access inside.
		Aster	Polyester + FG Laminated	5	5-31	350-900	2	1½"-2½" Lateral/ Top	2/2	A classic in AstralPool's filtration with the widest range of choices. Robustness, user friendliness and reliability all in one.
		Aster OC-1	Polyester + FG Laminated	5	8-32	450-900	2	1½"-2½" Lateral	2/2	Filter specially designed for the cutting-edge medium, OC-1. Saves energy, water and time spent on maintenance.
		Vesubio	Polyester + FG Laminated	5	8-32	450-900	2	1½"-2½" Lateral/ Top	2/2	Excellent value for money in its category. A laminated filter suitable for any size of pool.
		Millennium	Blow-molded thermoplastic	2	6-17	380-660	2	1½" Lateral/ Top	2/2	Magnificent finish and resistance in the category of blow-molded filters. Cover all your filtration requirements with the Millennium monobloc.

· All media filters in this table can work equally with sand or glass, except for the Aster OC-1 range.
 · Performance based on internal tests and comparisons.

* Robustness and durability
 ** Warranty for tank / components

Nanofiber filter



Complies with Standard EN 16713-01



Auto versions can be connected to a 07444 manual valve, or a 70769 automatic valve



DESCRIPTION

Filter for residential pools up to 90m³ characterised by its high-quality filtration: 5-8 microns, self-cleaning function, small size. The NanoFiber filter uses an innovative material that delivers better quality filtration due to its network of nanofibers.

- Easy to use
- Reliable
- Lower water consumption
- Higher water filtration quality
- Compact
- Easy to clean
- Dirt slow to build up without limescale
- Compatible with current filter systems on the market
- Replacement filtration media

	Code	Standard Pack	Standard weight in kg	Standard volume in m ³
NanoFiber Auto 150 filter (10 m ³ /h)	67355-0100	1	10.68	0.116
NanoFiber Auto 180 filter (14 m ³ /h)	67356-0100	1	10.68	0.116
NanoFiber Auto 200 filter (18 m ³ /h)	67357-0100	1	10.68	0.116
Auto adaptor kit	67509	1	3.68	0.027
Replacement filtration media				
NanoFiber 150 filter (10 m ³ /h)	64837	1	9.68	0.093
NanoFiber 180 filter (14 m ³ /h)	64838	1	9.68	0.093
NanoFiber 200 filter (18 m ³ /h)	64839	1	9.68	0.093
For Nanofiber 150	65383	1	1.58	0.022
For Nanofiber 180	65384	1	1.58	0.022
For Nanofiber 200	65385	1	1.58	0.022

TECHNICAL FEATURES

Model	Filtration surface area (m ²)	Flow rate (m ³ /h)	Max. pool volume (m ³)
NanoFiber 150	4,5	10	70
NanoFiber 180	5,2	14	80
NanoFiber 200	6,0	18	90

Handles
Easier to open and transport

Flow rate range
From 10 to 18 m³/h

Maximum temperature
40°C

Connections
2"



Pressure gauge
Max. pressure 2.5 bar

Tinted plastic
easy to check the level of dirt in the water

Filtration quality
Up to 5-8 microns (μ)

Functions:
Filtration and backwashing

DIATOMACEOUS FILTERS

Clarity filter



Complies with Standard EN 16713-01

DESCRIPTION

Made in polyester and fibreglass. Supplied with pressure gauge, air vent and side mounted multiport valve. Filtration velocity 4.9 m³/h/m².

	Code	Standard Pack	Standard weight in kg	Standard volume in m ³
Filters Ø 600 mm				
11000 l/h Outlet 1½" Model DE-24	11619	1	34.0	0.410
16400 l/h Outlet 1½" Model DE-36	11620	1	39.0	0.460
21800 l/h Outlet 2" Model DE-48	11621	1	44.0	0.550
27300 l/h Outlet 2" Model DE-60	11622	1	48.0	0.610

Multiport valve for Clarity filter



DESCRIPTION

This valve is valid only for the diatomaceous earth filter "Clarity".

	Code	Standard Pack	Standard weight in kg	Standard volume in m ³
Multiport valve with filter connections (config. 2)				
For D.E. filter 1½"	15385	6	15.5	0.079
For D.E. filter 2"	15389	6	22.7	0.158

Diatomaceous earth



DESCRIPTION

	Code	Standard Pack	Standard weight in kg	Standard volume in m ³
Celatom FW-60. 20 Kgs bag	03247	1	20	0.60
Celite 545. 23 Kgs bag	03246	1	23	0.60

Viron cartridge filter



Complies with Standard EN 16713-01

DESCRIPTION

Manufactured in injection-moulded plastic and suitable for high-pressure applications. Easy-access closing system, filtration surfaces of 39m² or 50m² enabling prolonged intervals between each cleaning operation or cartridge replacement. Includes water purge, oil pressure gauge and connection accessories. 5-year guarantee on the tank. Complies with filtration requirements as per standard EN 16713-1.

	Code	Standard Pack	Standard weight in kg	Standard volume in m ³
Viron QL 420 cartridge filter	76340	1	48	0.252
Viron QL 540 cartridge filter	76341	1	50	0.355

TECHNICAL FEATURES

Model	Filtration area	Maximum flow rate	Weight	Height
Viron QL 420	39 m ²	500 lpm	35 kg	943 mm
Viron QL 540	50 m ²	500 lpm	40 kg	943 mm

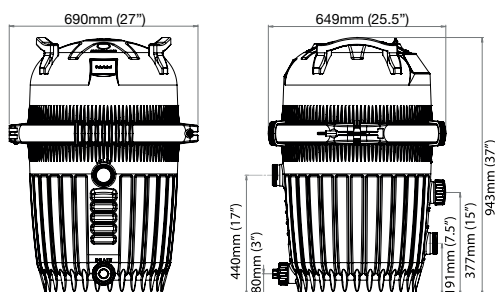

PRE-FILTERS

Hydrospin & Hydrospin Compact



DESCRIPTION

Hydrocyclone pre-filters can be fitted to filtration systems in both new and old installations. Hydrospin is able to treat flows up to 30 m³/h with a maximum working pressure of 2.5 bars. It is fitted between the pump and the filter and separates out solids of up to 40 micra, thus reducing by half the amount of water consumed for cleaning the filtration system. HydroSpin has a device for collecting solids with three separate areas (settling, clarifying and clouding). It can be cleaned using just five litres of water without having to stop the pump.

	Code	Standard Pack	Standard weight in kg	Standard volume in m ³
Hydrospin	45289	1	7.8	0.088
Hydrospin Compact	53743	1	4.0	0.033
Kit for wall installation, for 45289	47158	4	4.2	0.117

TECHNICAL FEATURES

	45289	53743
Working pressure (bar)	2,5	2,5
Connections	Ø 63	Ø 50 thread 2¼"
Purge connection	1"	¾"
Min. flow rate (m ³ /h)	5	3
Max. flow rate (m ³ /h)	30	16.5
Water for cleaning (l)	5	15
Separate solids (micron)	40	60
Floor support	Included	
Wall support	Accessory 47158	Included

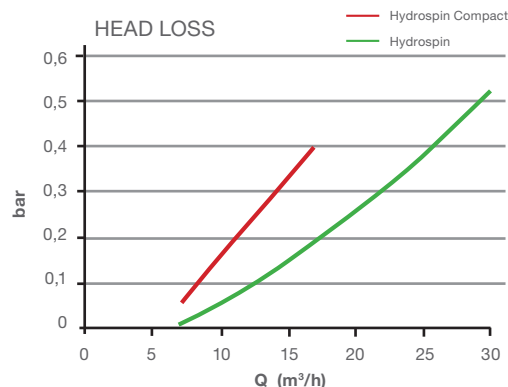

OC-1 FILTERS

Aster OC-1 filter



Complies with Standard EN 16713-01

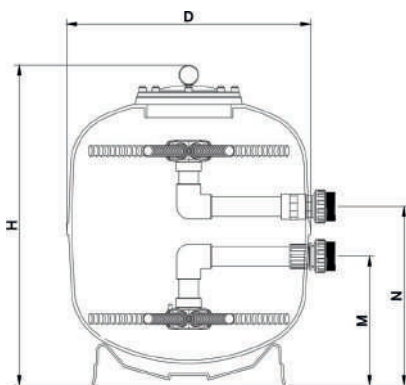

DESCRIPTION

White laminated polyester and fibreglass filter. Internal parts with special sides for OC-1 media. Filter for side selector valve. ¼" air and water purge. Transparent lid with screws. Maximum temperature: 50°C Maximum pressure 2.5 bar. Maximum filtration speed 50m³/h/m². Filter for OC-1 filtration media. Not compatible with sand, glass or other filter loads.

	Code	Standard Pack	Standard weight in kg	Standard volume in m ³
With multiport side valve				
OC-1 Aster filter 450	68642	1	21	0.23
OC-1 Aster filter 500	68643	1	23	0.28
OC-1 Aster filter 600	68644	1	28	0.39
OC-1 Aster filter 650	68645	1	29	0.45
OC-1 Aster filter 750	68646	1	37	0.62
OC-1 Aster filter 900-2"	68647	1	55	1.27
Without multiport valve				
OC-1 Aster filter 900-2½"	68648	1	55	1.27

TECHNICAL FEATURES

	68642	68643	68644	68645	68646	68647	68648
Ø D (mm)	450	500	600	650	750	900	900
H (mm)	845	855	900	955	1035	1100	1100
M (mm)	305	290	330	370	325	365	390
N (mm)	430	415	455	495	555	635	660
Connections	1½"	1½"	1½"	1½"	2"	2"	2½"
Flow (m ³ /h) at 50 m ³ /h/m ²	8	10	14	17	22	32	32
Maximum pressure (kg/cm ²)	2.5	2.5	2.5	2.5	2.5	2.5	2.5
Pool volume (m ³)	64	72	112	120	168	240	240
Filtration surface (m ²)	0.159	0.196	0.283	0.332	0.442	0.636	0.636
OC-1 volume (L)	44	59	78	125	181	313	313
OC-1 (kg)	9	12	16	25	36	63	63
Net weight (kg)	18	20	25	26	33	50	50

OC-1

THE FUTURE OF SWIMMING POOL FILTRATION



SAVE TIME
Reduce your cleaning frequency to one third of traditional media.



SAVE WATER
Unique filtration method reduces water consumption by up to 70%.



WATER QUALITY
Consistent filtration and water quality because of stable flow.



SAVE POWER
Great reduction in filter's head loss makes it possible to use smaller pumps or reduce power.

Tested by 

ASTRALPOOL 

OC-1 
FILTRATION MEDIA

Optional:
Standard American sizes

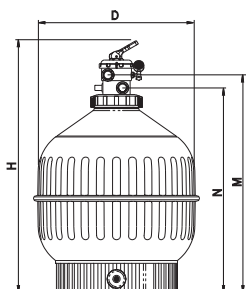

Complies with Standard
EN 16713-01

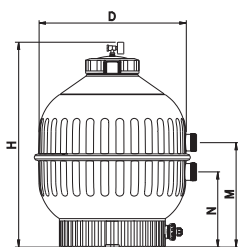

- + Injection-moulded filter in technical plastics.
- + Ivory. Thermal-welded joining of top and bottom filter parts.
- + Fitted with a pressure gauge and manual water and air purge valves.
- + Selector valve included.
- + Maximum filtration speed (m³/h/m²).
- + Maximum working pressure: 2.5 kg/cm².
- + Sand and glass compatible (see page 180).
- + Complies with filtration requirements as per standard EN 16713-1.

Cantabric top filter

ASTRALPOOL

DESCRIPTION

Top mounted multiport valve. Threaded filter locking ring in ABS.

	Code	Standard Pack	Standard weight in kg	Standard volume in m ³
6000 l/h Ø 400 mm outlet 1½"	22399	1	10.7	0.23
9000 l/h Ø 500 mm outlet 1½"	15780	1	17.5	0.37
14000 l/h Ø 600 mm outlet 1½"	15781	1	19.9	0.49
21000 l/h Ø 750 mm outlet 1½"	20128	1	30.4	0.83
21000 l/h Ø 750 mm outlet 2"	23866	1	32.1	0.83

Side mounted Cantabric filter

ASTRALPOOL

DESCRIPTION

Clear lid & threaded locking ring in ABS, supplied with side mounted multiport valve.

	Code	Standard Pack	Standard weight in kg	Standard volume in m ³
With multiport side valve				
6,000 l/h Ø 400 mm outlet 1½"	22398	1	9.0	0.15
9,000 l/h Ø 500 mm outlet 1½"	15782	1	15.8	0.29
14,000 l/h Ø 600 mm outlet 1½"	15783	1	17.8	0.40
21,000 l/h Ø 750 mm outlet 2"	15784	1	29.0	0.67
Without multiport valve				
30,000 l/h Ø 900 mm outlet 2½"	22402	1	49.0	1.30

TECHNICAL FEATURES

	Top mounted					Side mounted				
	22399	15780	15781	20128	23866	22398	15782	15783	15784	22402
Ø D (mm)	400	500	600	750	750	400	500	600	750	900
H (mm)	894	1009	1069	1239	1250	715	800	875	1045	1215
M (mm)	744	829	894	1064	1098	380	415	445	575	675
N (mm)	680	765	830	1000	1023	255	290	320	345	405
Connections	1½"	1½"	1½"	1½"	2"	1½"	1½"	1½"	2"	2½"
Flow rate (m ³ /h)	6	9	14	21	21	6	9	14	21	30
Approx. pool volume (m ³) (8 hours)*	48	72	112	168	168	48	72	112	168	240
Sand load (kg)	60	100	150	300	300	60	100	150	300	550
Grade 1 glass load (57011) (kg)	50	88	100	200	200	50	88	100	200	375
Grade 3 glass load (57013) (kg)	0	0	25	50	50	0	0	25	50	100
Net weight (kg)	8	14	15	23	25	7	12	14	24	34
Package volume (m ³)	0.2	0.37	0.49	0.83	0.83	0.15	0.29	0.4	0.67	1.3

Fitted with sand dump port of Ø 2" in Ø 750 mm & Ø 900 mm models, and of 1½" in Ø 400, Ø 500 & Ø 600 mm models.
* 8 hours turnover rate.

BLOW-MOULDED SAND FILTERS

- + Blow-moulded in a single seamless piece of plastic.**
- + Fitted with a pressure gauge and integrated air purge and manual water drain.**
- + Selector valve included.**
- + Maximum working pressure: 2.5 kg/cm² for filter Ø 380 mm, Ø 430 mm and Ø 480 mm, and 2 kg/cm² for filter Ø 560 mm and Ø 660 mm.**
- + Sand- and glass-compatible (see page 180).**
- + Complies with filtration requirements as per standard EN 16713-1.**



Complies with Standard EN 16713-01

Optional:
Standard American sizes

Millennium filters with Top mounted valve 

	Code	Standard Pack	Standard weight in kg	Standard volume in m ³
Ø 380 mm - 5500 l/h outlet 1½"	33814	1	12.0	0.17
Ø 430 mm - 7000 l/h outlet 1½"	33815	1	14.0	0.17
Ø 480 mm - 9000 l/h outlet 1½"	33816	1	16.0	0.24
Ø 560 mm - 12000 l/h outlet 1½"	33817	1	17.0	0.35
Ø 660 mm - 17000 l/h outlet 1½"	33818	1	24.5	0.52

Millennium filters with side mounted valve 



Complies with Standard EN 16713-01

	Code	Standard Pack	Standard weight in kg	Standard volume in m ³
Ø 380 mm - 5500 l/h outlet 1½"	35321	1	10.5	0.13
Ø 430 mm - 7000 l/h outlet 1½"	22497	1	13.0	0.13
Ø 480 mm - 9000 l/h outlet 1½"	22499	1	16.0	0.18
Ø 560 mm - 12000 l/h outlet 1½"	22501	1	18.0	0.26
Ø 660 mm - 17000 l/h outlet 1½"	28254	1	29.0	0.42

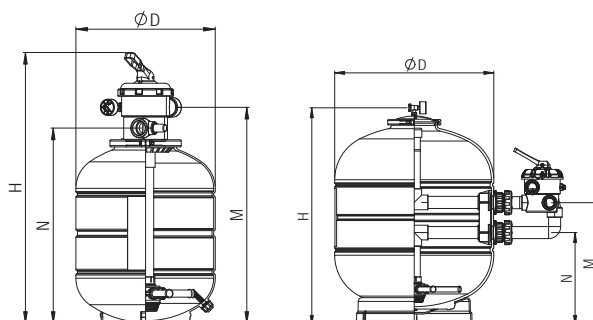

	TECHNICAL FEATURES	
	Top monoblock	Side monoblock
	28299	28301
Ø D (mm)	660	660
Pump	Sena	Sena
Power (HP)	1.25	1.25
Voltage (V)	230 II	230 II
Voltage (V)	50	50

	A - Top mounted filter					B - Side mounted filter				
	33814	33815	33816	33817	33818	35321	22497	22499	22501	28254
Ø D (mm)	380	430	480	560	660	380	430	480	560	660
H (mm)	820	835	870	945	1050	615	655	682	770	900
M (mm)	650	665	700	775	880	225	265	292	380	510
N (mm)	585	600	635	710	815	100	140	167	255	385
Length L (mm)	-	-	-	-	-	-	-	-	-	-
Connections	1½"	1½"	1½"	1½"	1½"	1½"	1½"	1½"	1½"	1½"
Flow rate (m ³ /h)	5.5	7	9	12	17	5.5	7	9	12	17
Pool volume approx. (m ³)	up to 40	40-50	50-75	75-100	140	up to 40	40-50	50-75	75-100	140
Sand load (kg)	± 40	± 60	± 80	± 110	± 180	± 40	± 60	± 80	± 110	± 180
Grade 1 glass load (57011) (kg)	± 35	± 50	± 70	± 90	± 150	± 35	± 50	± 70	± 90	± 150
Grade 3 glass load (57013) (kg)	0	0	0	0	25	0	0	0	0	25
Maximum pressure (kg/cm ²)	2.5	2.5	2.5	2	2	2.5	2.5	2.5	2	2
Net weight (kg)	12	13.5	15	16.5	24	10	12	15	17.5	28
Package volume (m ³)	0.17	0.17	0.24	0.35	0.52	0.13	0.13	0.18	0.26	0.42

LAMINATED SAND FILTERS

- + Filters manufactured in fibreglass and polyester resin.
- + With a gelcoat external finish. As a result, the body is highly resistant, durable and has an excellent finish.
- + Internal components and accessories in high quality engineering plastics.
- + Compatible with sand and glass, among others (see page 180).
- + They comply with filtration requirements as per standard EN 16713-1.

Atlas filter



Complies with Standard EN 16713-01

DESCRIPTION

Sand and glass filters, among others, made from reinforced polyester. Complies with filtration requirements as per standard EN 16713-1.

Technical features:

- Made of polyester resin and fibreglass.
- Excellent finish with gel-coat colour RAL 8029.
- The filter has been designed with higher coefficient of security, to guarantee a perfect operation.
- The union of the two bodies of the filter is carried out through a seal specially reinforced with fibreglass and polyester resin.
- Transparent plastic cover highly resistant to chemicals.
- High reliability screw-in cover.
- Fitted with 1" collector arms and diffuser made from unplasticized PVC.
- Interior pipe with tubes of PN-16.
- 2½" sand discharge outlet.
- Fitted with pressure gauge, air purge and manual water drain.
- Connections to multiport valve with six positions: filter, backwash, rinse, recirculate, waste and closed.
- Innovation by AstralPool: the filter has a built-in safety valve to prevent pressure surges.
- Maximum pressure: 2.5 kg/cm².

	Code	Standard Pack	Standard weight in kg	Standard volume in m ³
Includes multiport valve				
Ø 500 mm outlet 1½"	36596	1	20	0.29
Ø 600 mm outlet 1½"	36597	1	25	0.41
Ø 750 mm outlet 2"	36598	1	33	0.77
Multiport valve not included				
Ø 900 mm outlet 2½"	36599	1	51	1.23

* Figures without valve

TECHNICAL FEATURES

Code	36596	36597	36598	36599
Ø Filter (mm)	500	600	750	900
Connections	1½"		2"	2½"
Filtering surface (m ²)	0.19	0.30	0.44	0.64
Filtering velocity (m ³ /h/m ²)	50			
Flow rate (m ³ /h)	9.5	15	22	30
Maximum pressure (kg/cm ²)	2.5			
Sand load (kg)	120	190	360	580
Grade 1 glass load (57011) (kg)	100	150	225	375
Grade 3 glass load (57013) (kg)	0	0	50	100
Net weight (kg)	20	25	33	51

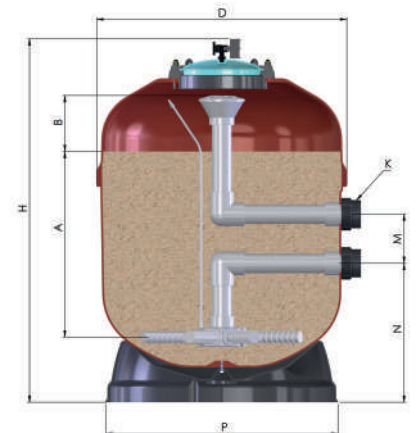

Sand drain of 2 ½" and water drain of ¾" with security valve.

Europe Pro - Pro Long filters



DESCRIPTION

Filters manufactured in fibreglass and polyester resin Complies with filtration requirements as per standard EN 16713-1. Sand and glass compatible (see page 180).

- Filter colour (Ral5015)
- ¼" purge valve.
- 2 ½" sand discharge
- Polyester or methacrylate cover with screws.
- Diameter of top access: 285 mm.
- Maximum pressure: 2.5 bar.



	Code	Standard Pack	Standard weight in kg	Standard volume in m ³
Pro version				
With methacrylate cover				
9500 l/h Ø 500 mm output 1½"	64990	1	15	0.33
15000 l/h Ø 600 mm output 2"	64991	1	20	0.45
22000 l/h Ø 750 mm output 2"	64992	1	25	0.83
30000 l/h Ø 900 mm output 2½"	64993	1	46	1.43
With polyester cover				
9500 l/h Ø 500 mm output 1½"	64986	1	15	0.33
15000 l/h Ø 600 mm output 2"	64987	1	20	0.45
22000 l/h Ø 750 mm output 2"	64988	1	25	0.83
30000 l/h Ø 900 mm output 2½"	64989	1	46	1.43
Pro Long version				
With methacrylate cover				
9500 l/h Ø 500 mm output 1½"	64998	1	23	0.33
15000 l/h Ø 600 mm output 2"	64999	1	26	0.45
22000 l/h Ø 750 mm output 2"	65000	1	34	0.83
30000 l/h Ø 900 mm output 2½"	65002	1	65	1.43
With polyester cover				
9500 l/h Ø 500 mm output 1½"	64994	1	23	0.33
15000 l/h Ø 600 mm output 2"	64995	1	26	0.45
22000 l/h Ø 750 mm output 2"	64996	1	34	0.83
30000 l/h Ø 900 mm output 2½"	64997	1	65	1.43

* Figures without valve

TECHNICAL FEATURES

	Pro version				Pro Long version			
	64990	64991	64992	64993	64998	64999	65000	65002
With methacrylate cover	64990	64991	64992	64993	64998	64999	65000	65002
With polyester cover	64986	64987	64988	64989	64994	64995	64996	64997
Ø D (mm)	500	600	750	900	500	600	750	900
Connection	1½"	2"	2"	2½"	1½"	2"	2"	2½"
Selector valve code	00599	28476	28512	24837	00599	28476	28512	24837
Filtration surface area (m ²)	0.19	0.3	0.44	0.64	0.19	0.3	0.44	0.64
Filtration velocity (m ³ /h/m ²)	50				50			
Flow (m ³ /h) at 50 m ³ /h/m ²	9.5	15	22	30	9.5	15	22	30
Maximum pressure (kg/cm ²)	2.5				2.5			
Sand load (kg)	120	190	360	580	155	240	430	615
Grade 1 glass load (57011) (kg)	100	150	250	375	100	150	275	400
Grade 3 glass load (57013) (kg)	0	0	50	100	25	50	75	100
Net weight (kg)	15	20	25	46	20	25	33	51
Depth of filter bed (mm)	390	445	530	645	520	565	620	680



Complies with Standard EN 16713-01

RapidPool filter



 Complies with Standard
EN 16713-01

**Filtration bed
0.6 m**

DESCRIPTION

Laminated in reinforced polyester with fibreglass. Red, polypropylene base, screw-free lid, cap for sand and water discharge, pressure gauge and air purge incorporated in the lid and side selector valve. Maximum filtration speed 50/h/m². Maximum pressure: 2.5 bar. Sand and glass compatible (see page 180).

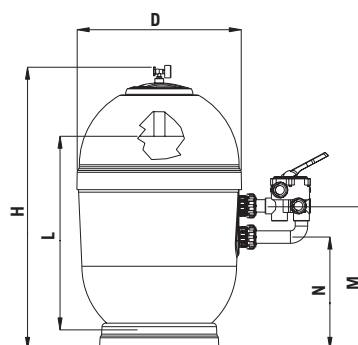
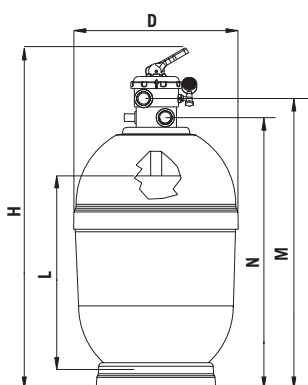
	Code	Standard Pack	Standard weight in kg	Standard volume in m ³
Top mounted valve version				
6000 l/h Ø 400 mm outlet 1½"	32427	1	19	0.200
9000 l/h Ø 500 mm outlet 1½"	32428	1	25	0.355
15000 l/h Ø 650 mm outlet 1½"	32429	1	34	0.600
24000 l/h Ø 800 mm outlet 2"	33849	1	45	1.050
Side mounted valve version				
6000 l/h Ø 400 mm outlet 1½"	00488	1	19	0.150
9000 l/h Ø 500 mm outlet 1½"	00489	1	25	0.280
15000 l/h Ø 650 mm outlet 1½"	00490	1	34	0.500
24000 l/h Ø 800 mm outlet 2"	00491	1	45	0.880



TECHNICAL FEATURES

	With Top mounted multiport valve				With multiport valve			
	32427	32428	32429	33849	00488	00489	00490	00491
Ø Filter (mm)	400	500	650	800	400	500	650	800
H (mm)	1020	1165	1285	1566	860	1032	1126	1272
M (mm)	850	995	1115	1355	442	527	552	592
N (mm)	790	935	1055	1279	317	402	427	362
Connections	1½"	1½"	1½"	2"	1½"	1½"	1½"	2"
Flow (m ³ /h) at 50 m ³ /h/m ²	6	9	15	24	6	9	15	24
Pool volume (m ³) (8 h)	48	72	120	120	48	72	120	192
Sand load (kg)	60	130	255	445	60	130	255	445
Grade 1 glass load (57011) (kg)	50	100	175	275	50	100	175	275
Grade 3 glass load (57013) (kg)	0	0	25	75	0	0	25	75
Sand height (mm)	545	571	650	785	545	571	650	785
Maximum pressure (kg/cm ²)	2.5	2.5	2.5	2.5	2.5	2.5	2.5	2.5
Net weight (kg)	19	25	34	44	15	22	30	45
Package volume (m ³)	0.20	0.355	0.60	1.05	0.16	0.3	0.53	0.9

Aster filter

DESCRIPTION

Filter laminated in polyester and fibreglass. Grey, polypropylene base, screw-free lid, cap for sand and water discharge, pressure gauge and side selector valve. Maximum pressure 2.5 bar. Maximum filtration speed 50/h/ m². Complies with filtration requirements as per standard EN 16713-1. Sand and glass compatible (see page 180).



Complies with Standard EN 16713-01

	Code	Standard Pack	Standard weight in kg	Standard volume in m ³
With top mounted multiport valve				
5000 l/h Ø 350 mm outlet 1½"	30768	1	17	0.13
8000 l/h Ø 450 mm outlet 1½"	30769	1	20	0.23
9000 l/h Ø 500 mm outlet 1½"	30770	1	22	0.28
14000 l/h Ø 600 mm outlet 1½"	30771	1	27	0.39
15000 l/h Ø 650 mm outlet 1½"	30772	1	28	0.45
21000 l/h Ø 750 mm outlet 2"	33847	1	35	0.62
32000 l/h Ø 900 mm outlet 2"	33848	1	53	1.27
With side mounted multiport valve				
5000 l/h Ø 350 mm outlet 1½"	00497	1	18	0.13
8000 l/h Ø 450 mm outlet 1½"	00498	1	21	0.23
9000 l/h Ø 500 mm outlet 1½"	19781	1	23	0.28
12000 l/h Ø 550 mm outlet 1½"	32706	1	27	0.28
14000 l/h Ø 600 mm outlet 1½"	00499	1	28	0.39
15000 l/h Ø 650 mm outlet 1½"	21071	1	29	0.45
18000 l/h Ø 680 mm outlet 1½"	28479	1	30	0.46
21000 l/h Ø 750 mm outlet 2"	00500	1	37	0.62
32000 l/h Ø 900 mm outlet 2"	08133	1	55	1.27
Without multiport valve				
31000 l/h Ø 900 mm outlet 2½"	00501	1	53	1.27

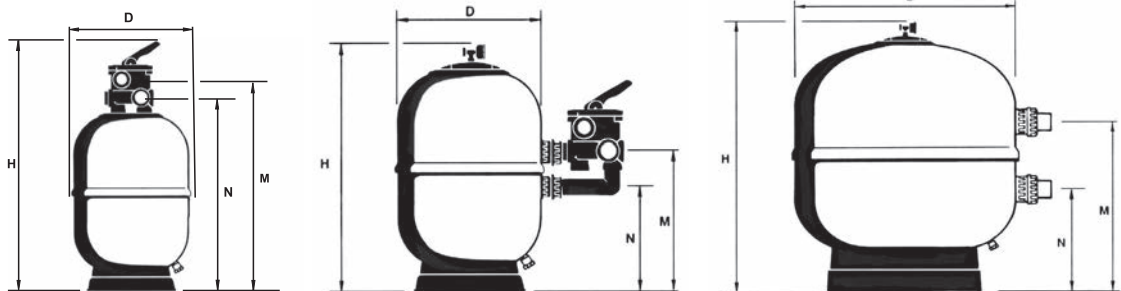

TECHNICAL FEATURES

	With Top mounted multiport valve							With multiport valve								Without valve	
	30768	30769	30770	30771	30772	33847	33848	00497	00498	19781	32706	00499	21071	28479	00500	08133	00501
Ø D (mm)	350	450	500	600	650	750	900	350	450	500	550	600	650	680	750	900	900
H (mm)	910	965	960	1005	1060	1184	1344	780	795	770	825	850	880	915	945	1050	1050
M (mm)	740	795	790	835	890	973	1133	420	430	415	455	455	480	525	555	635	660
N (mm)	680	785	730	775	830	897	1057	295	305	290	330	330	355	400	325	365	390
Connections	1½"	1½"	1½"	1½"	1½"	2"	2"	1½"	1½"	1½"	1½"	1½"	1½"	1½"	2"	2"	2½"
Flow (m ³ /h) at 50 m ³ /h/m ²	5	8	9	14	15	21	31	5	8	9	12	14	15	18	21	30	30
Pool volume (m ³) (8 h)	40	64	72	112	120	168	240	40	64	72	96	112	120	144	168	240	240
Sand load (kg)	50	70	90	110	200	290	500	50	70	90	110	125	200	210	290	500	500
Grade 1 glass load (57011) (kg)	50	50	75	100	150	175	325	50	50	75	100	100	150	150	175	325	325
Grade 3 glass load (57013) (kg)	0	0	0	0	0	50	75	0	0	0	0	0	0	25	50	75	75
Maximum pressure (kg/cm ²)	2.5	2.5	2.5	2.5	2.5	2.5	2.5	2.5	2.5	2.5	2.5	2.5	2.5	2.5	2.5	2.5	2.5
Net weight (kg)	17	20	22	27	28	35	53	18	21	23	27	28	29	30	37	55	53
Package volume (m ³)	0.13	0.23	0.28	0.39	0.45	0.62	1.27	0.13	0.23	0.28	0.28	0.39	0.45	0.46	0.62	1.26	1.27

Vesubio filter

DESCRIPTION

The Vesubio range has been expanded to reach both the public and private pool sectors. Filters manufactured using simultaneous projection of resin and fibreglass. Threaded lid with high-resistance screws. Ø 210mm top mouth. Ø 1050mm and Ø 1200mm models also available with a top mouth of Ø 400mm. Maximum pressure 2.5 bar. Sand and glass compatible (see page 180).



Complies with Standard
EN 16713-01

Filters with a side connection up to Ø 1050 mm can use a multiport selector valve (see page 178).

Ø 900 and Ø 1050 mm filters with side outlets are supplied without multiport valve.

	Code	Standard Pack	Standard weight in kg	Standard volume in m ³
Side mount version				
8000 l/h Ø 450 mm outlet 50 mm	15785	1	16	0.200
9000 l/h Ø 500 mm outlet 50 mm	19353	1	20	0.260
14000 l/h Ø 600 mm outlet 50 mm	15786	1	23	0.357
22000 l/h Ø 750 mm outlet 63 mm	15787	1	32	0.595
32000 l/h Ø 900 mm outlet 75 mm	15788	1	48	1.003
43000 l/h Ø 1050* mm outlet 75 mm	15789	1	97	2.052
43000 l/h Ø 1050** mm outlet 75 mm	32391	1	97	2.052
56000 l/h Ø 1200* mm outlet 90 mm	15790	1	130	2.450
56000 l/h Ø 1200** mm outlet 90 mm	32392	1	140	2.430
Top mount version				
8000 l/h Ø 450 mm outlet 50 mm	32430	1	19	0.280
9000 l/h Ø 500 mm outlet 50 mm	32431	1	23	0.350
14000 l/h Ø 600 mm outlet 50 mm	32432	1	26	0.480
22000 l/h Ø 750 mm outlet 63 mm	33850	1	40	0.787
32000 l/h Ø 900 mm outlet 63 mm	33851	1	56	1.276

* Small upper lid of Ø 210 mm

** Upper lid of Ø 400 mm

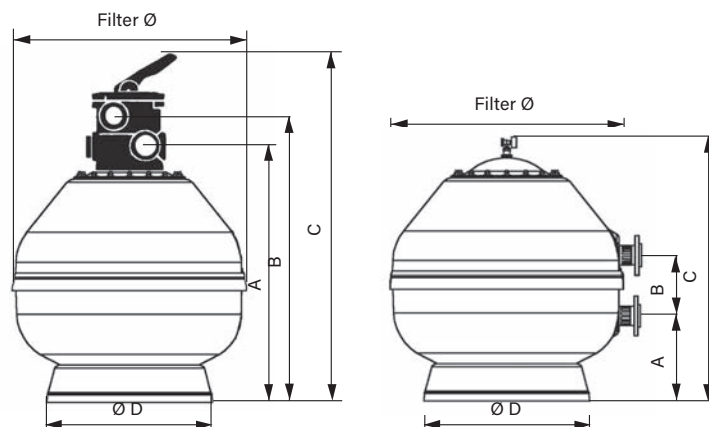

TECHNICAL FEATURES

	With Top mounted multiport valve					With multiport valve									
	32430	32431	32432	33850	33851	15785	19353	15786	15787	15788	15789	32391	15790	32392	
Ø Filter (mm)	450	500	600	750	900	450	500	600	750	900	1050	1050	1200	1200	
A (mm)	650	690	790	837	987	265	305	325	300	325	435	410	490	490	
B (mm)	710	750	850	913	1063	125	125	125	230	270	270	270	270	270	
C (mm)	880	920	1020	1124	1274	725	765	865	895	1080	1110	1235	1235	1360	
D (mm)	347	400	400	490	625	347	400	400	490	625	760	775	855	940	
Filtration surface area (m ²)	0.16	0.19	0.30	0.44	0.64	0.16	0.19	0.30	0.44	0.64	0.86	0.86	1.13	1.13	
Connections	1½"	1½"	1½"	2"	2"	1½"	1½"	1½"	2"	2½"	2½"	2½"	90	90	
Flow (m ³ /h) at 50 m ³ /h/m ²	8	9	14	22	32	8	9	14	22	32	43	43	56	56	
Pool volume (m ³) (8 hours)	64	72	112	176	256	64	72	112	176	256	344	344	448	448	
Sand load (kg)	60	95	148	245	415	60	95	148	245	415	660	660	1000	1000	
Grade 1 glass load (57011) (kg)	50	75	125	150	275	50	75	125	150	275	500	500	775	775	
Grade 3 glass load (57013) (kg)	0	0	0	50	50	0	0	0	50	50	125	125	200	200	

- Laminated filters with higher filter bed for enhanced performance and filtration quality, both for single-layer and multi-layer filters.
- There are various options to help choose the model that best suits usage and maintenance requirements.
- Compatible with sand, glass and anthracite, among others (see page 181).
- They comply with filtration requirements as per standard EN 16713-1.

Norma filter



DESCRIPTION

Filter laminated in fibreglass-reinforced polyester (FRP). For single layer or multilayer filling. Maximum pressure 2.5 bar. The Norma filter is designed according to Germany's DIN 19643/19605 standard. Available with a plate collector system (0.5 mm slot) including a manhole cover for inspection of the bottom. Fitted with a sight glass, Ø 200mm top lid for loading sand and Ø 200mm or Ø 400mm side mouth depending on model. Fitted with pressure gauge, air purge and manual water drain. Interiors in PVC and PP. A4 screws and EPDM gaskets. Standard colour: ivory. Options. Vinyl ester coating (ozone resistant, concentrations <0.4 ppm and max temp 40°C). Sand and glass compatible (see page 180).

Code	Standard Pack	Standard weight in kg	Standard volume in m ³
------	---------------	-----------------------	-----------------------------------

Maximum pressure: 2.5 kg/cm²
Filtration velocity 30

Diameter Ø mm	Outlet Ø mm	Flow rate m ³ /h at 30 m ³ /h/m	Code	Standard Pack	Standard weight in kg	Standard volume in m ³
650	90-75	10	08142P	1	100	1.33
800	90-75	15	08143P	1	125	2.00
1.000	140-110	23	08144P	1	145	3.00
1.200	140-140	34	08145P	1	177	5.50

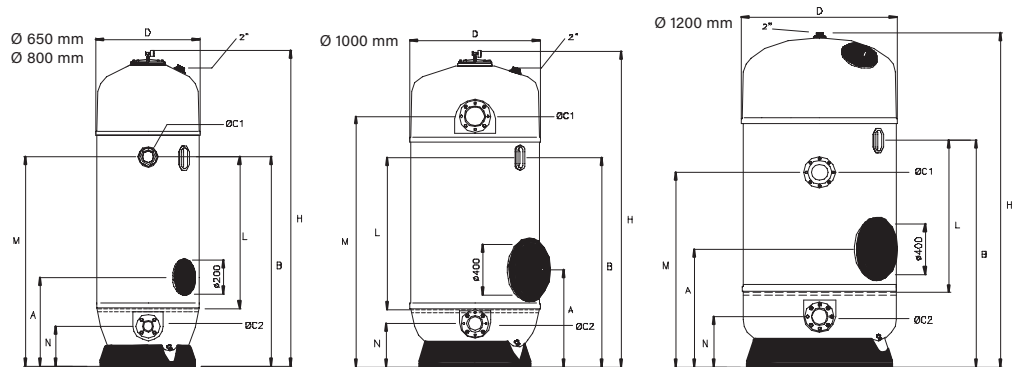

Complies with Standard EN 16713-01

Filtration bed 1.2 m

TECHNICAL FEATURES

	08142P	08143P	08144P	08145P
D (mm)	650	800	1000	1200
A (mm)	680	700	770	950
B (mm)	1660	1640	1655	1790
H (mm)	2480	2480	2490	2640
L (mm)	1200	1200	1200	1200
M (mm)	1650	1650	1980	1600
N (mm)	320	320	340	400
Ø C1 (mm)	90	90	140	140
Ø C2 (mm)	75	75	110	140
Flow (m ³ /h) at 30 m ³ /h/m ²	10	15	23	33
MULTILAYER	Anthracite 0.8 - 1.6 mm (l)	148	250	390
	Sand 0.4 - 0.8 mm (Kg)	160	271	420
	Gravel 1 - 2 mm (Kg)	46	78	120
	Gravel 3 - 5 mm (Kg)	46	78	120
SINGLE LAYER	Sand load (kg)	451	767	1215
	Gravel load (kg)	46	78	120
	Grade 1 glass load (57011) (kg)	275	500	750
	Grade 2 glass load (57012) (kg)	100	150	250
	Grade 3 glass load (57013) (kg)	100	175	275

Delta 1200 filter



Complies with Standard EN 16713-01

**Filtration bed
1.2 m**

DESCRIPTION

Filter laminated in polyester and fibreglass available in diameters of 650, 800, 1000 and 1200 mm. It has a 1.2-m filter bed and is available with an arm collector system and a plate collector system. Complies with filtration requirements as per standard EN 16713-1.

- DN 200 filter lid with quick-locking system for 650 and 800 models and DN 400 bolt down lid for 1000 and 1200 models.
- DN200 lateral manhole with bolt down cover.
- Filter interior left with natural resin finish.
- EASTAR sightglass as standard. Further sight glasses are available on request.
- Inner pipe and fittings in PVC, PP and ABS.
- Pressure gauge included in filter lid.
- Gaskets in EPDM and all screw fittings in stainless steel.
- Vinylester option. In this case, internal layer is manufactured from vinylester resin (and not only the top layer in contact with the water), to a maximum chemical resistance of 0.4 ppm of ozone dissolved and to a maximum temperature 50°.
- Comes in RAL 5024 blue.

	Code	Standard Pack	Standard weight in kg	Standard volume in m ³
Maximum pressure: 2.5 kg/cm²				
Conventional collector arms.				
Arm slots 0.3 mm				
Diameter Ø mm	Outlet Ø mm	Flow rate m ³ /h at 40 m ³ /h/m		
650	1½"	13.3	36680	1
800	2"	20.1	36681	1
1000	2½"	31.4	36682	1
1200	90	45.2	36683	1

Maximum pressure: 2.5 kg/cm²				
Nozzle collector plate.				
Nozzle slots 0.5 mm				
Diameter Ø mm	Outlet Ø mm	Flow rate m ³ /h at 40 m ³ /h/m		
650	1½"	13.3	36688	1
800	2"	20.1	36689	1
1000	2½"	31.4	36690	1
1200	90	45.2	36691	1

* Maximum flow and filtration velocity recommended

TECHNICAL FEATURES

	Collector arms				Nozzle collector plate			
	36680	36681	36682	36683	36688	36689	36690	36691
Sand load (kg)	451	767	1325	1763	451	767	1325	1763
Gravel load (kg)	86	156	300	350	46	78	120	175
Grade 1 glass load (57011) (kg)	325	500	850	1125	300	450	750	1050
Grade 2 glass load (57012) (kg)	100	175	275	375	100	150	250	350
Grade 3 glass load (57013) (kg)	100	175	300	400	100	175	275	375

Delta 1000 filter



Complies with Standard EN 16713-01

**Filtration bed
1 m**

**NB: Coding options
according to table on
page 830**

DESCRIPTION

Filter laminated in polyester and fibreglass available in diameters of 650, 800, 1000 and 1200 mm. It has a 1-m filter bed and is available with an arm collector system and a plate collector system. Complies with filtration requirements as per standard EN 16713-1.

- DN 200 filter lid with quick-locking system for 650 and 800 models and DN 400 bolt down lid for 1000 and 1200 models.
- DN200 lateral manhole with bolt down cover.
- Filter interior left with natural resin finish.
- Optional methacrylate sight glass on the Delta 10 model. More than one sight glass can be placed if desired.
- Inner pipe and fittings in PVC, PP and ABS.
- Pressure gauge included in filter lid.
- Gaskets in EPDM and all screw fittings in stainless steel.
- Vinylester option. In this case, internal layer is manufactured from vinylester resin (and not only the top layer in contact with the water), to a maximum chemical resistance of 0.4 ppm of ozone dissolved and to maximum temperature 50°.
- Comes in RAL 5024 blue.

	Code	Standard Pack	Standard weight in kg	Standard volume in m ³
--	------	---------------	-----------------------	-----------------------------------

Maximum pressure: 2.5 kg/cm²
Conventional collector arms.
Arm slots 0.3 mm

Diameter Ø mm	Outlet Ø mm	Flow rate m ³ /h at 40 m ³ /h/m				
500	1½"	8	58682	1	80	1.34
650	1½"	13.3	36676	1	80	1.34
800	2"	20.1	36677	1	90	1.71
1000	2½"	31.4	36678	1	125	2.16
1200	90	45.2	36679	1	150	3.29

Maximum pressure: 2.5 kg/cm²
Nozzle collector plate.
Nozzle slots 0.5 mm

Diameter Ø mm	Outlet Ø mm	Flow rate m ³ /h at 40 m ³ /h/m				
650	1½"	13.3	36684	1	94	1.34
800	2"	20.1	36685	1	111	1.71
1000	2½"	31.4	36686	1	155	2.16
1200	90	45.2	36687	1	190	3.29

* Maximum flow and filtration velocity recommended

TECHNICAL FEATURES

	Collector arms					Nozzle collector plate			
	58682	36676	36677	36678	36679	36684	36685	36686	36687
Sand load (kg)	245	400	640	990	1425	400	640	990	1425
Gravel load (kg)	60	86	156	300	350	46	78	120	175
Grade 1 glass load (57011) (kg)	175	275	450	725	1000	250	400	600	875
Grade 2 glass load (57012) (kg)	50	75	150	225	325	75	125	200	275
Grade 3 glass load (57013) (kg)	75	100	150	250	350	100	125	200	300

TECHNICAL FEATURES

FILTRATION



Fast lid opening for diameters 500, 650 and 800

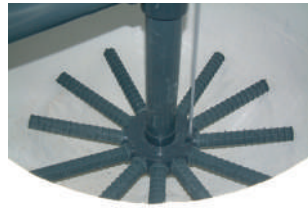

Collector arms detail



Lid D.400 for diameters 1000 and 1200



Nozzle plate detail

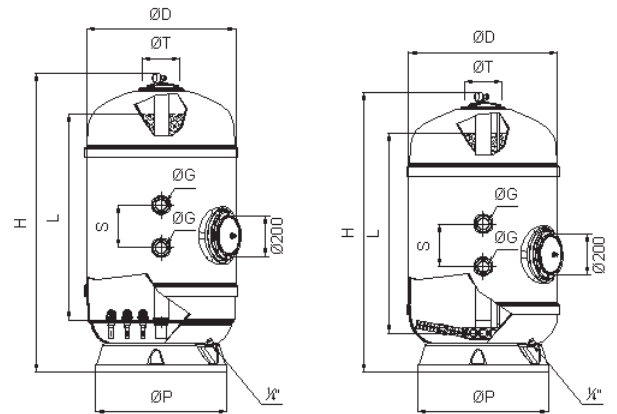

Delta 10 nozzle collector plate

Delta 10 nozzle collector arms

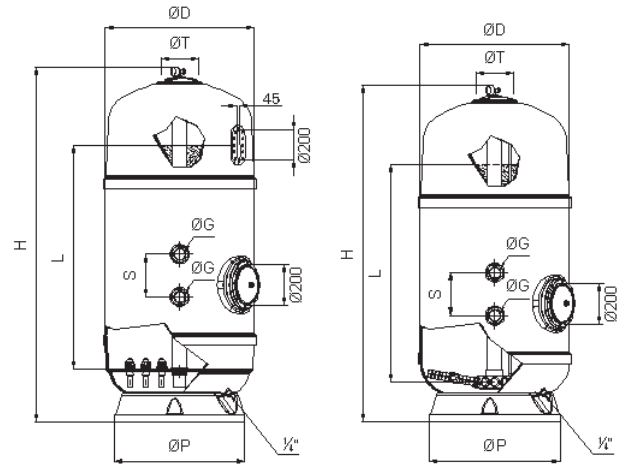

Delta 12 nozzle collector plate

Delta 12 nozzle collector arms



Complies with Standard EN 16713-01

	DELTA 10										DELTA 12							
	Collector arms					Nozzle collector plate					Collector arms				Nozzle collector plate			
	58682	36676	36677	36678	36679	36684	36685	36686	36687	36680	36681	36682	36683	36688	36689	36690	36691	
D (mm)	535	670	820	1.035	1.240	650	800	1.000	1.200	650	800	1.000	1.200	650	800	1.000	1.200	
Ø P (mm)	400	490	625	890	1145	490	625	890	1145	585	700	890	1145	585	700	890	1145	
H (mm)	1680	1702	1749	1840	1915	1770	1860	1870	1240	1920	1995	2010	2150	1920	1995	2010	2150	
L (mm)	-	1000	1000	1000	1000	1000	1000	1000	1000	1200	1200	1200	1200	1200	1200	1200	1200	
S (mm)	125	125	230	270	300	125	230	270	300	125	230	270	300	125	230	270	300	
Ø T	200	200	200	400	400	200	200	400	400	200	200	400	400	200	200	400	400	
Ø G	1/2"	1/2"	2"	2 1/2"	3"	1/2"	2"	2 1/2"	3"	1/2"	2"	2 1/2"	3"	1/2"	2"	2 1/2"	3"	
Flow rate m³/h at 30 m³/h/m²	5.88	9	15	23	34	9	15	23	34	9	15	23	34	9	15	23	34	
Flow rate m³/h at 40 m³/h/m²	7,84	12	20	30	45	12	20	30	45	12	20	30	45	12	20	30	45	
MULTILAYER	Anthracite 0.8 - 1.6 mm (l)	-	-	-	-	-	-	-	-	148	250	387	564	148	250	387	564	
	Sand 0.4 - 0.8 mm (Kg)	-	-	-	-	-	-	-	-	160	271	419	611	160	271	419	611	
	Gravel 1 - 2 mm (Kg)	-	-	-	-	-	-	-	-	46	78	120	175	46	78	120	175	
	Gravel 3 - 5 mm (Kg)	-	-	-	-	-	-	-	-	86	156	300	350	46	78	120	175	
SINGLE LAYER	Sand 0.4 - 0.8 mm (Kg)	245	400	640	990	1425	400	640	990	451	767	1325	1763	451	767	1325	1763	
	Gravel 1 - 2 mm (Kg)	60	86	156	300	350	46	78	120	86	156	300	350	46	78	120	175	
	Grade 1 glass load (57011) (kg)	175	275	450	725	1000	250	400	600	875	325	500	850	1125	300	450	750	1050
	Grade 2 glass load (57012) (kg)	50	75	150	225	325	75	125	200	275	100	175	275	375	100	150	250	350
Grade 3 glass load (57013) (kg)	75	100	150	250	350	100	125	200	300	100	175	300	400	100	175	275	375	

Artic Plus filter



Complies with Standard
EN 16713-01

**Filtration bed
1.2 m**

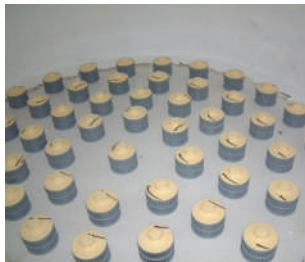

Nozzle plate detail



Collector arms detail

DESCRIPTION

Range of high-capacity retention filters with optimal backwash performance. Manufactured in polyester with an external gel-coat finish. Body of just two parts; ivory. Maximum working temperature of 50°C. Internal parts made from PVC plastic. Ø 400 lid to remove sand from bottom part of filter (optional) in Ø 1050 and Ø 1200 versions. Ø 650, 800, 950, 1050 and 1200 filters available with collector arms or nozzle plate. Compatible with sand and glass, among others (see page 180). Complies with filtration requirements as per standard EN 16713-1.

	Code	Standard Pack	Standard weight in kg	Standard volume in m ³
Collector arms system				
Ø 650 mm connection 1½"	36053-0100	1	80	1.45
Ø 800 mm connection 2"	36054-0100	1	95	1.85
Ø 950 mm connection 2½"	41373	1	136	2.54
Ø 1050 mm connection 3"	36055	1	145	2.73
Ø 1200 mm connection 4"	36056	1	220	4.10

TECHNICAL FEATURES

	36053	36054	41373	36055	36056
Ø D (mm)	680	825	970	1090	1255
H (mm)	1900	1950	1960	2145	2170
M (mm)	125	230	270	270	270
N (mm)	730	670	665	665	665
L (mm)			1200		
C (mm)			300		
P (mm)	490	625	705	775	940
T (mm)		200		400	
Connections	1½"	2"	2½"	3"	4"
Flow rate (m ³ /h)	16.5	25	35	43	56.5
Filtration area (m ²)	0.33	0.50	0.70	0.86	1.13
Sand load (kg)	470	660	1015	1240	1665
Gravel load (kg)	100	165	260	320	410
Grade 1 glass load (57011) (kg)	325	475	725	875	1175
Grade 2 glass load (57012) (kg)	100	150	225	275	375
Grade 3 glass load (57013) (kg)	125	150	250	300	400
Maximum pressure (kg/cm ²)			2.5		
Net weight (kg)	75	90	131	135	210
Water drain	1"	1"	1"	2½"	2½"
Injection-moulded plastic lid	Ø200	Ø200	Ø200	Ø400	Ø400

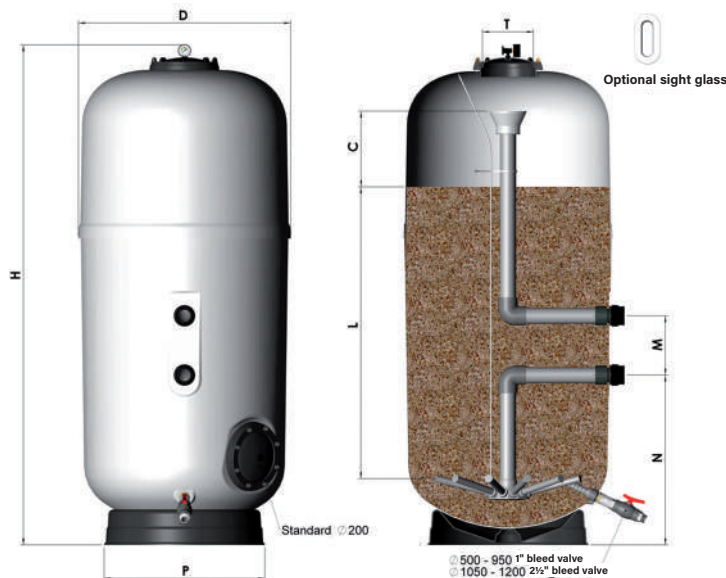

Artic filter

DESCRIPTION

Range of high-capacity retention filters with optimal backwash performance. Manufactured in polyester with an external gel-coat finish. Body of just two parts; ivory. Maximum working temperature of 50°C. Internal parts made from PVC plastic. Ø 400 lid to remove sand from bottom part of filter (optional) in Ø 1050 and Ø 1200 versions. Ø 650, 800, 950, 1050 and 1200 filters available with collector arms or nozzle plate. Compatible with sand and glass, among others (see page 180). Complies with filtration requirements as per standard EN 16713-1.



Complies with Standard EN 16713-01

Filtration bed
1 m

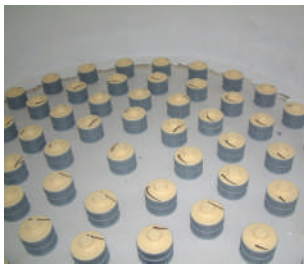

Nozzle plate detail



Collector arms detail

	Code	Standard Pack	Standard weight in kg	Standard volume in m ³
Collector arms system				
Ø 500 mm connection 1½"	34029-0100	1	65	1.30
Ø 650 mm connection 1½"	34030-0100	1	70	1.34
Ø 800 mm connection 2"	34031-0100	1	75	1.67
Ø 950 mm connection 2½"	41187	1	119	2.30
Ø 1050 mm connection 3"	41188	1	145	2.42
Ø 1200 mm connection 4"	41189	1	165	3.65

TECHNICAL FEATURES

	34029	34030	34031	41187	41188	41189
Ø D (mm)	535	680	825	970	1090	1255
H (mm)	1650	1700	1750	1760	1895	1970
M (mm)	125	125	230	270	270	270
N (mm)	780	775	685	655	630	665
L (mm)	1000					
C (mm)	300					
P (mm)	400	490	625	705	775	940
T (mm)	200				400	
Connections	1½"	1½"	2"	2½"	3"	4"
Flow rate (m ³ /h)	9.5	16.5	25	35	43	56.5
Filtration area (m ²)	0.19	0.33	0.50	0.70	0.86	1.13
Sand load (kg)	225	380	530	830	1015	1360
Gravel load (kg)	50	100	165	260	320	410
Grade 1 glass load (57011) (kg)	150	275	375	600	750	1000
Grade 2 glass load (57012) (kg)	50	75	125	200	250	325
Grade 3 glass load (57013) (kg)	50	100	150	225	275	350
Maximum pressure (kg/cm ²)	2.5	2.5	2.5	2.5	2.5	2.5
Net weight (kg)	60	65	70	109	135	155
Water drain	1"	1"	1"	1"	2½"	2½"
Injection-moulded plastic lid	Ø200	Ø200	Ø200	Ø200	Ø400	Ø400

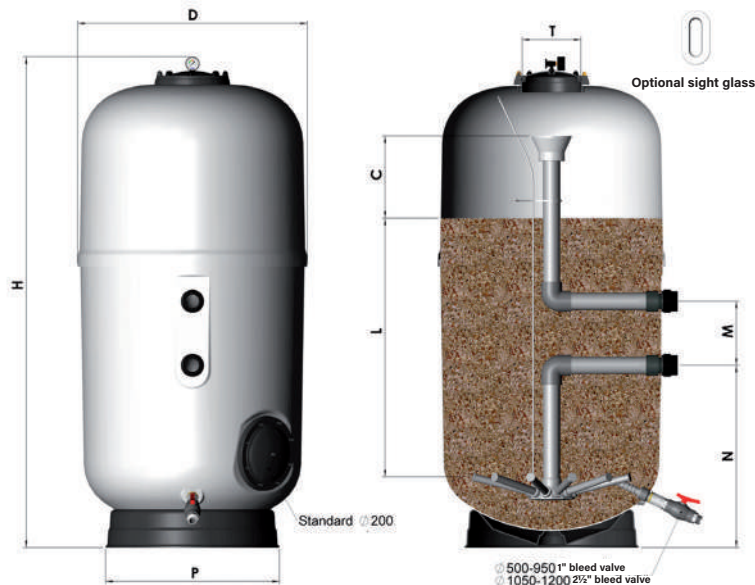

Aster filter - high quality of filtration



Complies with Standard EN 16713-01

Filtration bed 0.8 m

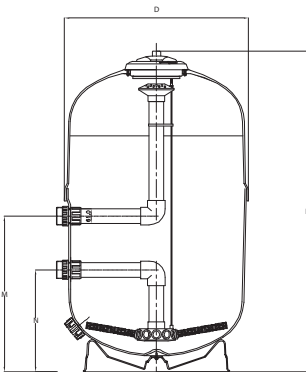

Complies with Standard EN 16713-01

Filtration bed 0.6 m

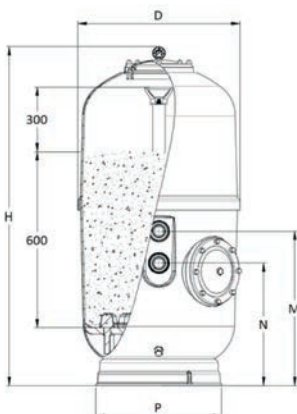

DESCRIPTION

Laminated filter made of fibreglass and polyester. Filter bed 800 mm in depth. Grey in colour, polypropylene base, fast open lid, water drainage plug, flowmeter and side multiport valve. Maximum pressure 2.5 bar. Top filtration speed of 50 m³/h/m². The filter can be used with a single layer or a multi-layer combination of gravel with sand, glass or anthracite. Quick-release lid. Has a 2½" sand discharge out let at the bottom of the filter. Optional sand discharge outlet of 200 mm. Optional vinylester interior finish for treatment with ozone. Maximum temperature 50°.

	Code	Standard Pack	Standard weight in kg	Standard volume in m ³
Ø 500 mm output 1½"	24768-0100	1	30	0.44
Ø 600 mm output 1½"	24769-0100	1	40	0.64
Ø 750 mm output 2"	24770-0100	1	60	1.0
Ø 900 mm output 2"	10003-0100	1	90	1.6
Ø 900 output 2½"	10004	1	90	1.6

TECHNICAL FEATURES

	24768-0100	24769-0100	24770-0100	10003-0100	10004
Ø D (mm)	500	600	750	900	
H (mm)	1365	1370	1435	1400	1435
M (mm)	605	605	665	825	865
N (mm)	480	480	435	595	595
Connections	1½"	1½"	2"	2"	2½"
Flow (m ³ /h) at 50 m ³ /h/m ²	9.5	16.5	21	31	
Pool volume (m ³)	75	120	175	250	
Sand load (kg)	200	300	450	580	
Gravel load (kg)	16	35	65	135	
Grade 1 glass load (57011) (kg)	125	200	300	400	
Grade 3 glass load (57013) (kg)	25	25	50	75	
Maximum pressure (kg/cm ²)	2.5				

Aster filter - high filtration with nozzle plate

DESCRIPTION

Filter laminated in polyester and fibreglass. Optional Ø 200mm sand discharge at bottom. Black screw-down lid ¼" water drain at bottom. Maximum pressure 2.5 bar. Maximum temperature 50°.

	Code	Standard Pack	Standard weight in kg	Standard volume in m ³
Ø 500 mm output 2"	24768FT01-110 000	1	30	0.46
Ø 600 mm output 2"	24769FT01-110 000	1	40	0.63
Ø 750 mm output 2"	24770FT01-110 000	1	60	0.99
Ø 900 mm output 2"	10003FT01-110 000	1	90	1.29
Ø 900 output 2½"	10004FT01-110 000	1	90	1.29

TECHNICAL FEATURES

	24768FT01 110 000	24769FT01 110 000	24770FT01 110 000	10003FT01 110 000	10004FT01 110 000
Ø D (mm)	500	600	750	900	
H (mm)	1365	1370	1435	1400	1435
M (mm)	605	605	665	825	865
N (mm)	480	480	435	595	
P (mm)	400	490	625	705	
Connections	1½"	1½"	2"	2"	2½"
Flow (m ³ /h) at 50 m ³ /h/m ²	9.5	16.5	21	31	
Pool volume (m ³)	75	120	175	250	
Sand load (kg)	200	300	450	580	
Gravel load (kg)	16	35	65	135	
Grade 1 glass load (57011) (kg)	125	200	300	400	
Grade 3 glass load (57013) (kg)	25	25	50	75	
Maximum pressure (kg/cm ²)	2.5				

- Filters made of fiberglass and polyester resin with Internal components and accessories in high quality engineering plastics.
- Thanks to its double coating, the resulting body is extremely resistant, durable and reliable.
- Compatible with sand and glass, among others (see page 180).
- They comply with filtration requirements as per standard EN 16713-1.

Berlin filter



Complies with Standard EN 16713-01

DESCRIPTION

Ø 230mm screw-down lid, injection-moulded. Fitted with manual air and water bleed valves, a pressure gauge and a side mounted multiport valve. Maximum filtration speed (m³/h/m²) Complies with filtration requirements as per standard EN 16713-1. Sand and glass compatible (see page 180).

	Code	Standard Pack	Standard weight in kg	Standard volume in m ³
With multiport valve:				
9000 l/h Ø 500 mm outlet 1½"	00541	1	17.3	0.24
14000 l/h Ø 600 mm outlet 1½"	00542	1	21.8	0.37
21000 l/h Ø 750 mm outlet 2"	00543	1	35.1	0.65
Without multiport valve:				
30000 l/h Ø 900 mm outlet 2½"	00544	1	53.4	1.01
30000 l/h Ø 900 mm outlet 2"	15397	1	53.4	1.01
30000 l/h Ø 900 mm outlet 2" (4 bar)	28474	1	67.0	1.01
Without multiport valve and with Ø 400 mm polyester and FV lid:				
43000 l/h Ø 1050 mm outlet Ø 75 mm	00545	1	110.0	1.92
56000 l/h Ø 1200 mm outlet Ø 90 mm	00546	1	140.0	2.70

* Figures without valve

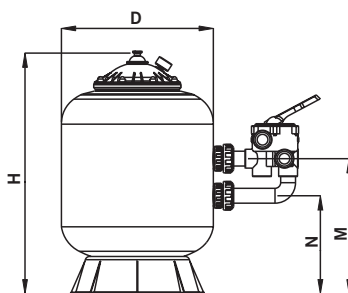

With multiport valve

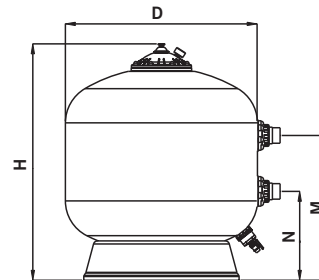

Without multiport valve

TECHNICAL FEATURES

	With multiport valve			Without multiport valve				
	00541	00542	00543	00544	15397	28474	00545	00546
Ø D (mm)	500	600	750	900	900	900	1050	1200
H (mm)	805	910	1050	1145	1135	1135	1300	1450
M (mm)	450	505	610	685	635	635	810	870
N (mm)	325	380	380	415	405	405	500	560
Connections	1½"	1½"	2"	2½"	2"	2"	*D75	**D90
Flow (m ³ /h) at 50 m ³ /h/m ²	9	14	21	30	30	30	43	56
Pool volume (m ³)	50-75	75-115	115-170	170-240	-	-	240-350	350-450
Sand load (kg)	100	175	300	525	525	525	575	800
Gravel load (kg)	-	-	-	-	-	-	300	300
Grade 1 glass load (57011) (kg)	75	150	200	350	350	350	600	825
Grade 3 glass load (57013) (kg)	0	0	50	75	75	75	175	200
Maximum pressure (kg/cm ²)	2.5	2.5	2.5	2.5	2.5	4	2.5	2.5
Net weight (kg)	15.3	19.8	33.1	51.4	51.4	51.4	100	130
Package volume (m ³)	0.35	0.37	0.65	1.01	1.01	1.01	1.92	2.70

MONOBLOCKS

Galactic monoblock



DESCRIPTION

Filter made made from high resistant blow-molded thermoplastic.

Includes 6-ways multiport valve, pressure gauge, manual air purge, water purge, compact self-priming pump with electrical cord and plug, hose, fittings, base and accessories to completely assembly the whole set.

Maximum working pressure 2,4 bars.

Fittings included, D38 and D50mm, for a maximum versatility to install.

Complies with filtration requirements as per standard EN 16713-1.

	Code	Standard Pack	Standard weight in kg	Standard volume in m ³
Ø380 - 5 m ³ /h	74471	1	20	0.33
Ø400 - 6 m ³ /h	74472	1	20.5	0.33
Ø500 - 8 m ³ /h	74473	1	24	0.37
Ø500 - 10 m ³ /h	74474	1	25.5	0.37
Ø600 - 12 m ³ /h	74475	1	29	0.42
Ø600 - 14 m ³ /h	74476	1	30	0.42

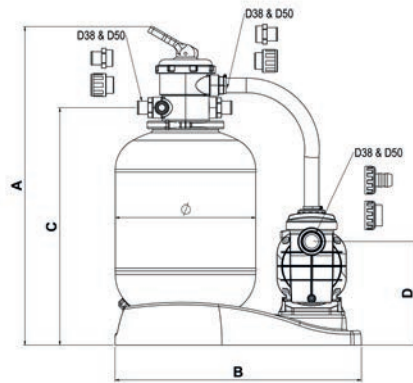

TECHNICAL FEATURES						
	74471	74472	74473	74474	74475	74476
Ø (mm)	380	400	500	500	600	600
A (mm)	860	905	975	975	1.030	1.030
B (mm)	710	710	830	830	830	830
C (mm)	635	650	740	740	816	816
D (mm)	295	295	295	295	295	295

TECHNICAL FEATURES							
CODE	FLOW m ³ /h	Ø FILTER mm	PUMP POWER HP	Ø FITTINGS mm	SAND kg*	BOX	
						WEIGHT Kg	DIMENSIONS mm
74471	5	380	1/3	38 / 50	40	20	790x600x700
74472	6	400	1/3	38 / 50	40	20.5	
74473	8	500	1/2	38 / 50	100	24	870x600x715
74474	10	500	3/4	38 / 50	100	25.5	
74475	12	600	3/4	38 / 50	150	29	870x600x800
74476	14	600	1	38 / 50	150	30	

* Sand not supplied.

SkyPool filter monoblock

with top outlet

 Complies with Standard
EN 16713-01

DESCRIPTION

Made from plastic with a clamp lid, multi-way valve, pressure gauge, manual air outlet and water purge. White. Injection-moulded black base. Maximum working pressure: 2 kg/cm². Complies with filtration requirements as per standard EN 16713-1.

	Code	Standard Pack	Standard weight in kg	Standard volume in m ³
Ø 300 mm - P-XPERT-4	M00504	1	12	0.11
Ø 400 mm - P-XPERT-6	M00505	1	14	0.22
Ø 400 mm - P-XPERT-8	M00506	1	15	0.22
Ø 500 mm - P-XPERT-10	M00507	1	20	0.28
Ø 500 mm - P-XPERT-14	M00661	1	22	0.28

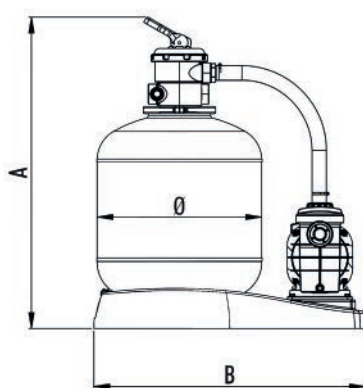

TECHNICAL FEATURES

Top monobloc	SkyPool / P-XPERT				
	M00504	M00505	M00506	M00507	M00661
A (mm)	640	760	760	840	840
B (mm)	520	830	830	830	830
Ø (mm)	300	400	400	500	500
Pump (HP)	P-XPERT4	P-XPERT6	P-XPERT8	P-XPERT10	P-XPERT14
Connections	Ø 38	Ø 38	Ø 38	1½"	1½"
Flow (m ³ /h)	4	6	7	9	11
Power (W)	150	340	490	600	660
Filtration speed (m ³ /m ² /h)	60	50	60	50	60
Sand 0.4-0.8 mm (Kg)	± 25	± 40	± 40	± 100	± 100
Weight (Kg)	12	14	15	20	22
Volume (m ³)	0.102	0.226	0.226	0.278	0.278

Ramses in-ground compact housing



DESCRIPTION

Embedded housing comprising an injection-moulded reinforced polymer body and lid. Complete and ready-assembled.

Connections: Ø50 PVC tube All pool types of up to 80m³

Components that include:

- 1 hp pump.
- Filter (according to model).
- 6-way top valve.
- Interior PVC connections and valves.

	Code	Standard Pack	Standard weight in kg	Standard volume in m ³
Ramses with Aster 550 filter	41910	1	76	1.18
Ramses with Millennium 560 filter	69829	1	68	1.18

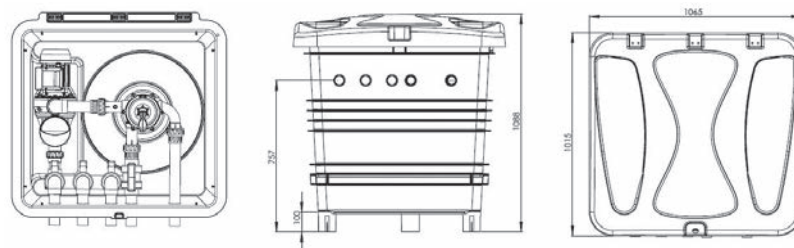

Keops in-ground compact with salt chlorinator

DESCRIPTION

Embedded housing comprising an injection-moulded reinforced polymer body and lid. Complete and ready-assembled.

Connections: Ø50 PVC tube All pool types of up to 100m³

Components that include:

- Advantages of Victoria Plus Silent 1HP
- Filter (according to model).
- 6-way side valve.
- Compact 100 salt chlorinator.
- Interior PVC connections and valves.

	Code	Standard Pack	Standard weight in kg	Standard volume in m ³
Keops with salt chlorinator and Cantabric 600 filter	69832	1	95	2.03
Keops with salt chlorinator and Aster 600 filter	69831	1	95	2.03

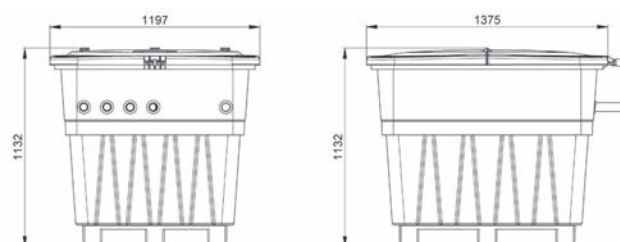

Ramses Up - Above ground compacts



DESCRIPTION

Designed for outdoor installation. Lid with reinforced edge. Size: 149 x 82 x 120.

	Code	Standard Pack	Standard weight in kg	Standard volume in m ³
Without inner assembly	74970	1	25	0.400
With Aster 550 Sena 1 HP	61423AS55001	1	75	1.5

See our wide range of housing according to your filtration needs

In-ground -compact housings



DESCRIPTION

Stackable to facilitate shipping and storage; streamlined interior to obtain top performance in the smallest possible space. Light cover with reinforced hinges. Prefabricated in polyester and fibreglass with a gelcoat finish. Outside of the cover in green and inside of the housing in ivory.

	Code	Standard Pack	Standard weight in kg	Standard volume in m ³
Supplied with openings for connections:				
For filters Ø 350 mm	00615/1	1	175	2.02
For filters Ø 400-450-500-600 mm	00616/1	1	156.5	2.54
For filters Ø 650-750-800 mm	00618	1	126.0	3.87

Semi in-ground compact housings



DESCRIPTION

Prefabricated in polyester and fibreglass. Ivory. Fully opening cover.

	Code	Standard Pack	Standard weight in kg	Standard volume in m ³
For filters Ø 450-500-600 mm	00619/1	1	80.0	2.7
For filters Ø 600-450-650-750 mm	00620/1	1	145.0	3.2

- A wide range of valves which offers the New Generation series, the Classic series and Flat series with 1½" and 2" valve configurations.
- The Magnum series with 2½" and 3" valves completes the range.

Six positions multiport valve















DESCRIPTION

A six positions multiport valve able to perform several functions in a hydraulic circuit: filtration, empty, closed, backwashing and rinsing of the filter. Its extremely functional design means that it can be fitted up to any installation. All joints will be perfectly sealed and it is easy to operate.

Its minimum friction and resistance, maximum safety were decisive factors to choose the best materials of its components: ABS body, lid and handle, PPO distributor, EPDM gaskets, metal parts in stainless steel.

CONNECTION OPTIONS IN MULTIPORT VALVE

Connection options	Connection	Outlets	New Generation		Classic		Classic Plus	Flat	Magnum		
											
			1 ½" Eco	1 ½"	2"	1 ½"	2"	1 ½"	1 ½"	2 ½"	3"
Configuration 1  "Top" inlet and "Bottom" outlet at the base. Commonly used for filters with a Top output valve.	Without connection	Threaded BSP		28509	11542	08938					
		Smooth			00597						
Configuration 2  "Top" inlet at the base and "Bottom" outlet on one side.	With connection	Threaded BSP									
		Smooth			15385	15389					
	Without connection	Threaded BSP		28510	11366	08939					
		Smooth									
Configuration 3  Filter inlet "Top" from the MPV side and filter outlet "Bottom" to the MPV base. This configuration can be supplied with pipework and connections for side mounting.	With connection	Threaded BSP									
		Smooth	20569	28512	00599	07444	73950	34543	24837		
		Threaded NPT	22355	30788	06673-0700	09848			24840		
	Without connection	Threaded BSP	23108	28511	14909	07441		34544	24838		
		Smooth	20043		00598			34545			
		Threaded NPT	22356	30795	06595	07440			24839	30798	
Configuration 4  Both the filter inlet "Top" and the filter outlet "Bottom" from and to the MPV sides.	Without connection	Threaded BSP		28513	11368	08940					
		Smooth									
Configuration 5  All inlets and outlets open.	Without connection	Threaded BSP		28514		Ask for code				28515	
		Smooth									
Top	Without connection	Threaded BSP									
		Smooth	32583	20565	33968	65216	22490		34546		
		Threaded NPT		22358			22492				

New Generation

- Manual multipoint valves which incorporate a bayonet closing system (replacing bolts).
- This eases dismantling for maintenance and prevents rust.
- The range includes the 1½" and 2" versions, including a "Top Eco" version available in 1½".

New generation

Selector valve with coupling to filter



	Code	Standard Pack	Standard weight in kg	Standard volume in m ³
Configuration 3 - 1½"	20569	6	14.0	0.079
Configuration 3 - 2"	28512	6	26.4	0.165
Configuration 3 - 1½" NPT	22355	6	14.0	0.079
Configuration 3 - 2" NPT	30788	6	26.4	0.165
Configuration 3 - 2" (special distance between con. 270mm - for filter 08133)	59968	6	24.6	0.165

New generation

1½" and 2" multipoint valve



	Code	Standard Pack	Standard weight in kg	Standard volume in m ³
Multipoint valve 1½" - Configuration 3	20043	6	11.5	0.079
Multipoint valve 2":				
Configuration 1	28509	6	22.3	0.165
Configuration 2	28510	6	22.3	0.165
Configuration 3	28511	6	22.3	0.165
Configuration 4	28513	6	22.3	0.165
Configuration 5	28514	6	22.3	0.165
Multipoint valve 1½" NPT - Configuration 3	22356	6	11.5	0.079
Multipoint valve 2" NPT - Configuration 3	30795	6	22.3	0.165

New generation

1½" and 2" multipoint valve. Top Config.



	Code	Standard Pack	Standard weight in kg	Standard volume in m ³
Top 1½" Multipoint valve	20565	6	12.10	0.079
Top 2" Multipoint valve	33968	1	3.95	0.028
Top 1½" NPT Multipoint valve	22358	6	12.10	0.079
Top 1½" Multipoint valve (for Aster filter)	31993	6	11.8	0.124
Top 2" Multipoint valve (for Aster filter)	33969	1	3.85	0.028

New generation

1½" multipoint valve. Top ECO version

DESCRIPTION

6-way multipoint valve for above ground pool filters where the pressure does not exceed 1.5 bar, of maximum diameter 380 mm. Bayonet closing system.

	Code	Standard Pack	Standard weight in kg	Standard volume in m ³
1½" multipoint valve. Top ECO version	32583	6	8.83	0.082

Classic Plus

- Manual multiport valves with six channels to carry out different functions in an hydraulic circuit.
- Connection to filter through a sweep elbow instead of a 90° elbow and new design to offer a reduced pressure loss.
- Diverter gasket placed in the diverter instead of the body to improve performance and maintenance.

Classic Plus

1½" and 2" multiport valve with filter connections



	Code	Standard Pack	Standard weight in kg	Standard volume in m³
1½" multiport valve - Configuration 3	73950	6	14.7	0.079

NEW CLASSIC PLUS SERIES:

This valve is completely compatible with the valve 00599, with improved characteristics (read the valve description).

Classic

- Manual multiport valves with six channels to carry out different functions in an hydraulic circuit.
- Its design, basically functional, offers a wide range of possibilities of connection to any installation, assuring perfect water-tightness and comfortable handling.



Classic

1½" and 2" multiport valve with filter connections



	Code	Standard Pack	Standard weight in kg	Standard volume in m ³
1½" multiport valve - Configuration 3	00599	6	15.5	0.079
2" multiport valve - Configuration 3	07444	6	22.7	0.150
1½" NPT multiport valve - Configuration 3	06673-0700	6	15.5	0.079
2" NPT multiport valve- Configuration 3	09848	6	22.7	0.150
2" multiport valve - Configuration 3 (special distance between con. 270mm - for filter 08133)	21263	6	22.2	0.165



Classic

1½" and 2" multiport valve



	Code	Standard Pack	Standard weight in kg	Standard volume in m ³
1½" multiport valve - Configuration 1	00597	6	12.2	0.079
1½" multiport valve - Configuration 3	00598	6	12.1	0.079
2" multiport valve - Configuration 3	07441	6	19.9	0.150
1½" NPT multiport valve - Configuration 3	06595	6	12.1	0.079
2" NPT multiport valve - Configuration 3	07440	6	19.9	0.150

Classic

2" TOP multiport valve



65216



22490

DESCRIPTION

6-way TOP multiport valve for residential pools. Body, cover and handle injected in ABS.

	Code	Standard Pack	Standard weight in kg	Standard volume in m ³
Top 1½" Multiport valve	65216	6	14.6	0.123
Top 2" Multiport valve	22490	1	3.45	0.028
2" TOP multiport valve NPT	22492	1	3.45	0.028

Flat

- Multiport valve which features a special compact look thanks to its single-level design (compared to the normal twin-level set-up in other multiport valves).
- This reduced size makes the equipment especially suitable in installations where space is at a premium, such as in filter housing or monoblocks.



Flat

1 1/2" lateral multiport valve with filter connections



	Code	Standard Pack	Standard weight in kg	Standard volume in m ³
Configuration 3	34543	6	9.3	0.08



Flat

1 1/2" lateral multiport valve - Flat



	Code	Standard Pack	Standard weight in kg	Standard volume in m ³
Configuration 3 (bottom port threaded)	34544	6	9.3	0.08
Configuration 3 (bottom port solvent socket)	34545	6	9.3	0.08



Flat

1 1/2" TOP multiport valve - Flat



	Code	Standard Pack	Standard weight in kg	Standard volume in m ³
	34546	6	9.3	0.08

Magnum

- Specially designed to support high working pressures and connection to large filters which require special connections.
- Choose from the models offered: 2 1/2", 3" and 4" multiport valves.



Magnum

2 1/2" multiport valve with filter connections



DESCRIPTION

Multiport valve with filter connections.

	Code	Standard Pack	Standard weight in kg	Standard volume in m ³
2 1/2" multiport valve - Configuration 3	24837	1	9.5	0.060
2 1/2" NPT multiport valve - Config. 3	24840	1	9.5	0.060



Magnum

2 1/2" multiport valve



DESCRIPTION

Filter inlet from the side and outlet from the bottom. With threaded outlets.

	Code	Standard Pack	Standard weight in kg	Standard volume in m ³
2 1/2" multiport valve - Configuration 3	24838	1	8.2	0.061
2 1/2" NPT multiport valve - Config. 3	24839	1	8.2	0.061



Magnum

3" multiport valve



DESCRIPTION

Side mounted multiport valve for connecting to filters. Body and cover injected in ABS with fiberglass. Handle injected in ABS. Sealing system by stainless steel screws. Supplied with two plugs so that the customer can adapt the valve to the most suitable configuration.

	Code	Standard Pack	Standard weight in kg	Standard volume in m ³
3" multiport valve	28515	1	9.8	0.064
3" NPT multiport valve	30798	1	9.8	0.064

MULTIPOINT VALVES

VRAC Flat

1½" automatic multipoint system valve



DESCRIPTION

Basic automatic multipoint valve model that stands out for its easy operation.
Voltage 230/115 volts. Controls filtration, backwashing, rinsing and emptying.

	Code	Standard Pack	Standard weight in kg	Standard volume in m ³
TOP 1½" multipoint valve with actuator	43512	1	4.1	0.02
SIDE 1½" multipoint valve with actuator	43513	1	3.9	0.02

VRAC III

automatic multipoint valve



A multipoint safety valve (code 41898 or 41899) is recommended.

**Substituted codes:
72433 in substitution of 70768 and 57186.
72434 in substitution of 70769 and 57187**

DESCRIPTION

Improved automatic multipoint valve operated via button keypad. It makes possible to control filtration, backwashing, rinsing, emptying, recirculation and closed positions.

NEW in 2021!

Better features to the automatic multipoint valve replacing the pressure switch for an analog pressure sensor.

- Easy program of the pressure set point for backwashing - Pressing a button.
- Avoid corrosion - No metallic elements.
- Friendly set up Fluidra Connect Box - System VRAC Basic III
- Adaptable: For using in all devices with a media filter, and it is quick and easy to install.
- Comfort: With a simple programming using the keypad, you will receive a fully automated filtration for your pool.
- Hygiene: You will obtain an optimal water quality for swimming, optimizing the wash cycles (daily, weekly or by pressure monitoring).
- Safety: The automatic valve continuously monitors the filtration system and the valve, thus preventing potential breakdowns. New power surge protection. Spring coated to prevent rusting.

LED lights for quick look of basic information.

	Code	Standard Pack	Standard weight in kg	Standard volume in m ³
Basic 1½" side mounted, Config. 3	72433	1	4.27	0.023
Basic 2" side mounted, Config. 3	72434	1	5.75	0.033

Hydraulic safety valve



DESCRIPTION

The 1 ½" hydraulic safety valve in the drain is specially designed for installation in the drain outlet of an automatic multipoint valve on a pool sand filter.

Using it prevents water loss when the valve changes its working position or when the electricity flow fails and the valve remains in a position in which it could empty the pool.

It is recommended in installations with SYSTEM VRAC multipoint valves.

	Code	Standard Pack	Standard weight in kg	Standard volume in m ³
With 50 mm straight double connection	41898	2	1.8	0.02
With 1 ½" BSP double pipe connection	41899	2	1.8	0.02

Gauge panel unit



DESCRIPTION

Including air vents.

	Code	Standard Pack	Standard weight in kg	Standard volume in m ³
With pressure gauges 3 kg/cm ²	00729	1	1	0.007
With pressure gauges 6 kg/cm ²	00730	1	1	0.007

OC-1 filtration media



DESCRIPTION

OC-1 filtration load: The future of pool filtration

OC refers to Open Cell and OC-1 is a mechanical filter that uses open-cell filtration technology to filter water with a high quality, increasing the water saving and energy potential. The filtration media is an extruded plastic compound comprising a base of High Density Polyethylene with Calcium Carbonate.

- Saves water: exclusive filtration method that reduces water consumption by more than 40%.
- Saves power: lets you use a smaller pump or lower the power to get the same flow you would with traditional filtration media.
- Saves time: OC-1 reduces backwash frequency to less than a third of traditional methods, meaning more leisure time for you.
- The OC-1 media has been tested in accordance with current European standard EN16713-1.

	Code	Standard Pack	Standard weight in kg	Standard volume in m ³
OC-1 50L filtration media bag	69752	1	9.0	0.05
OC-1 20L filtration media bag	69753	1	3.6	0.02

Active Clear Glass



DESCRIPTION

AstralPool sells Active Clear Glass filtration material.

Active Clear Glass has the following benefits:

- More efficient and ecological filtration with water and energy savings.
- Higher filtration capacity with a cleaner bed that traps bacteria.

	Code	Standard Pack	Standard weight in kg	Standard volume in m ³
Granulometry				
0.5 mm - 1.0 mm	57011	1	25.0	0.667
1.0 mm - 3.0 mm	57012	1	25.0	0.667
3.0 mm - 7.0 mm	57013	1	25.0	0.667

TECHNICAL FEATURES

	Code	Range	% Volume of the filter bed	
			Filters D < 900 mm	Filters D > 900 mm
Range 1	57011	0.5 - 1.0 mm	0.8	0.6
Range 2	57012	1.0 - 3.0 mm	0	0.2
Range 3	57013	3,0 - 7,0 mm	0.2	0.2

Silex



DESCRIPTION

Other silex grades available to order.

25 Kg bag.

	Code	Standard Pack	Standard weight in kg	Standard volume in m ³
Granulometry 0.4 - 0.8 mm	00596	1	25	0.667

Gravel



DESCRIPTION

Please ask for a quotation for other grades.

25 Kg bag.

	Code	Standard Pack	Standard weight in kg	Standard volume in m ³
Granulometry 1 - 2 mm	10697	1	25	0.667
Granulometry 3 - 5 mm	11346	1	25	0.667

Anthracite



DESCRIPTION

Please ask for a quotation for other grades.

25 Kg bag.

	Code	Standard Pack	Standard weight in kg	Standard volume in m ³
Granulometry 0.8 - 1.6 mm	03696	1	25	0.8

Zeolite

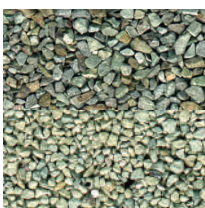

DESCRIPTION

Natural porous material that has higher filtration qualities than the normal substrate. It can be compared to that of diatoms, at a much more competitive price and longer duration.

	Code	Standard Pack	Standard weight in kg	Standard volume in m ³
Zeolite standard 0.5 - 1 mm	25845	1	25	-
Zeolite standard 1-2 mm	25846	1	30	0.023
Zeolite standard 2-5 mm	25847	1	30	0.023

Diatomaceous earth



	Code	Standard Pack	Standard weight in kg	Standard volume in m ³
Celatom FW-60. 20 Kgs bag	03247	1	20	0.60
Celite 545. 23 Kgs bag	03246	1	23	0.60



PUMPS



184 PUMP FEATURES AND SELECTION

187 VARIABLE SPEED PUMPS

187 Victoria Plus Silent VS

188 SELF-PRIMING PUMPS

188 Victoria Plus Silent

189 Verdon ES

191 Senext XP

192 Sena

193 Boise

194 CONTROL BOXES

198 COUNTERCURRENT SWIMMING EQUIPMENT - SELECTION & EQUIPMENT

PUMP SELECTION GUIDE

HOW DO YOU SELECT THE PUMP THAT YOU NEED?

PUMPS

The selection of the pump is essential for running a pool's water treatment system.

The pump is the heart of a water facility and provides the power that makes the water circulate.

Its main use is to filter the water so that it is clear and to ensure its full recirculation. The main steps for selecting a pump are:

- Setting the flow rate required depending on the pool's volume and dirt load. The flow rate must always be suitable for the filter fitted. It is very important that it neither be too slow nor too fast.
- Setting the pressure required depending the hydraulic facility's features.
- Taking into account any other units that may have been installed, such as salt chlorinators and heat pumps,

whenever they involve constraints on the flow rate or pressure. For example, if a minimum flow rate is required for a unit to run.







- Selecting the pump ranges that supply this flow rate and pressure.
- Choosing the pump with the features that are best suited to a pool's requirements and those of its owner.

Pumps also have other uses, such as running water features and massage jets. In such cases, read the specifications for each use and select the right pump.







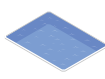
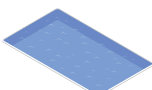
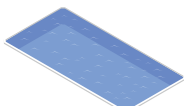

Variable speed technology delivers the highest levels of comfort and features. It is without a doubt the best choice for the most exacting users.

PUMP RANGES AND MAIN ADVANTAGES

To select the right pump, you can use the following table that shows the features according to pool size.

FEATURES				
COMFORT VARIABLE SPEED	<ol style="list-style-type: none"> 1. Extra silent 2. Power savings. Low power consumption 3. High quality filtration 4. Connected and connectable 5. Low maintenance: large capacity prefilter 	 Victoria Plus Silent VS		
		 Victoria Plus Silent		
COMFORT SINGLE SPEED	<ol style="list-style-type: none"> 1. Low and easy maintenance: large capacity prefilter 2. High efficiency 3. Wide range of flow rates suitable for practically any type of residential pool 4. High hydraulic performance 	 Verdon ES		
		 Senext XP		
COMPACT SINGLE SPEED	<ol style="list-style-type: none"> 1. Small footprint: compact prefilter 2. Intermediate hydraulic performance 3. For small- and medium-sized pools 	 Sena		
		 Boise		
		 SMALL POOL		
		 MEDIUM-SIZED POOL		
		 LARGE POOL		

PUMP FEATURES AND SELECTION

	VARIABLE SPEED COMFORT	SINGLE SPEED COMFORT		SINGLE SPEED COMPACT		
						
	VICTORIA PLUS SILENT VS	VICTORIA PLUS SILENT	VERDON ES	SENEXT XP	SENA	BOISE
Range	100 - 200	50 - 300	50 - 300	33 - 150	33 - 125	33 - 125
Flow rate range (m³/h)	17.0 - 26.0	8.0 - 33.0	7.0 - 31.0	5.0 - 21.0	3.5 - 16.3	6.0 - 19.0
Power supply	1~	1~ and 3~ for all	1~ from 50 to 75 1~ & 3~ from 100 to 300	1~ from 33 to 50 1~ & 3~ from 75 to 150	1~ from 33 to 50 1~ & 3~ from 75 to 125	1~
Hydraulic fittings	D50 to D63 or 2"	D50 to D75 or 2"	D50 to D75	D50	D50	D50
Couplings included	Yes D50-D63 acc. to power	Yes D50-D75 acc. to power	Yes D50-D75 acc. to power	Yes D50	Yes D50	Yes D50
Full backward compatibility with pump-friendly installations	Victoria Plus	Victoria Plus	ESPA Silen S2*	SPECK Badu* Magna/Top* HAYWARD MaxFlo*/ SuperPool*	IML America	--
Prefilter size (l)	3	3	3	2.0	0.9	1.1
Efficiency	★★★★★	★★★★★	★★★★★	★★★★★	★★★★★	★★★★★
Noise (dBA)	62 - 47	61	64	61	62	63
Possible controls	Standalone Dry contacts Fluidra Connect remote control Automated system	On/Off	On/Off	On/Off	On/Off	On/Off
Program settings	Hourly 3 speeds	--	--	--	--	--
User interface	LCD display Removable interface	--	--	--	--	--
Automation compatible	Yes - Fluidra Connect	--	--	--	--	--
Warranty						

□ Table of self-priming filtration pumps for residential pools.
 □ For details on backward compatibility in multi-compatibility ranges, see the product's technical specifications, catalogue or website.
 □ Total efficiency (hydraulic power/electric power consumed). Comparison based on internal tests on the ranges shown in this table.
 □ Noise. Based on internal tests. A 1 HP model for ranges with multiple powers.
 □ Flow rates at 10 m.c.w. for Comfort ranges and at 8 m.c.w. for Compact ranges.

*These are third-party brands that are not related to Fluidra.

VICTORIA PLUS SILENT VS

Shhhhh... Relax and enjoy the silence of your pool

A NEW GENERATION OF FILTRATION PUMPS



Silent

At just 45 dB, it is amongst the most silent pumps in the market



Savings

A variable speed pump that could see you save as 900€ in power consumption



Fluidra Connect connectivity

Download the app and program it from your mobile phone or tablet



User-friendly display

Easy to use and program with the added bonus that it can be installed on a wall



Easy to replace

Compatible with all earlier Victoria models by AstralPool



Reliability

Cutting-edge engineering tested for a long, problem-free service life





DESCRIPTION

The Victoria Plus Silent pump for residential pools comes with two motor powers, has variable speeds and can be automatically controlled.

This pump has been designed for both new-build pools and as a replacement for pumps already fitted.

Significant power savings can be made thanks to the use of variable speeds and the timer.

The pump is compatible with the Fluidra Connect platform.

It has a built-in HMI controller with the possibility of mounting it on a wall for better usability.

Bathers experience a greater feeling of well-being due to the reduced noise level.

There are digital inputs and outputs for the smooth running of all pool units, such as the salt chlorinator and heat pump. It includes a power factor correction function for reducing current flow. It does not require an external power pack for Fluidra Connect.

	Code	Standard Pack	Standard weight in kg	Standard volume in m ³
Victoria Plus Silent VS 100	67547	1	19	0.087
Victoria Plus Silent VS 200	67548	1	22	0.087

TECHNICAL FEATURES

	67547			67548		
	LOW	MEDIUM	HIGH	LOW	MEDIUM	HIGH
Speed (rpm)	1400	2100	2750	1400	2100	2750
Voltage (V)	220-240	220-240	220-240	220-240	220-240	220-240
Frequency (Hz)	50/60	50/60	50/60	50/60	50/60	50/60
Power (W)	170	470	1030	258	750	1560
Current (A)	1	2.2	4.5	1.4	3.4	7.1
Flow rate (m ³ /h)	8.2	12.4	16.7	11.1	18.8	25.5
Pressure (m)	2.7	6.1	10	3.2	6.2	10
Efficiency (l/Wh)	48.3	26.4	16.2	43	25	16.3
Max. working pressure (m)	4	9	15.5	4	9.4	16.3
Noise (dB)	45	53	61	51	58	66



Fluidra Connect compatible

PERFORMANCE

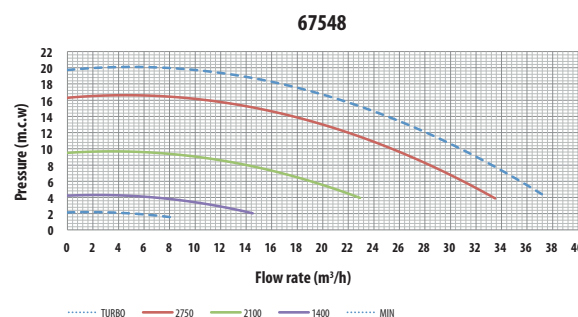
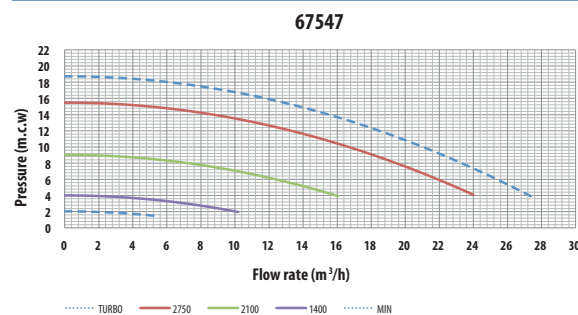

Menu-driven adjustments and settings

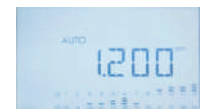

Intuitive weekly timer settings



Pre-set and adjustable speeds



Power consumption and savings display

Installation and control:



HMI control system on pump



HMI control system on wall

Victoria Plus Silent



DESCRIPTION

A self-priming pump with single-phase and three-phase motors. A prefilter is mounted on the body of the pump to prevent foreign bodies from entering it that may damage its hydraulic parts. The motors supplied come with an IP-55 protection rating and have been prepared to withstand hot environments and high levels of humidity. GS marking. The main characteristics of Victoria Plus Silent are:

- Low noise level: between 61 dB and 70 dB.
- Easy to use: Prefilter cap with 2 levers included (no spanner needed).
- Compatibility: Fully compatible in pools fitted with a Victoria Plus pump.
- Larger front bearing for improved axial thrust.
- PVC accessories assembly included in pump.



	Code	Standard Pack	Standard weight in kg	Standard volume in m ³
Victoria Plus Silent 50M	65557	1	12	0.07
Victoria Plus Silent 50T	65558	1	12	0.07
Victoria Plus Silent 75M	65560	1	13	0.07
Victoria Plus Silent 75T	65561	1	13	0.07
Victoria Plus Silent 100M	65562	1	14	0.07
Victoria Plus Silent 100T	65563	1	14	0.07
Victoria Plus Silent 150M	65564	1	17	0.07
Victoria Plus Silent 150T	65565	1	17	0.07
Victoria Plus Silent 200M	65566	1	18	0.07
Victoria Plus Silent 200T	65567	1	19	0.07
Victoria Plus Silent 300M	65569	1	23	0.07
Victoria Plus Silent 300T	65570	1	19	0.07

TECHNICAL FEATURES

REF	MODEL	Voltage	Flow at H _N	Nominal Head	Maximum Head	Maximum Flow	Motor Rated Output	Maximum Absorbed Power	Pipe Size
		U _N	Q _N	H _N	H _{MAX.}	Q _{MAX.}	P _{2N}	P _{IMAX}	D
		V	m ³ /h	m	m	m ³ /h	kW	kW	mm
65557	50M	230	7.5	10	13	14.5	0.38	0.58	D50
65558	50T	230/400	7.5	10	13	14.5	0.38	0.55	D50
65560	75M	230	11	10	15	18	0.56	0.72	D50
65561	75T	230/400	11	10	14	18	0.56	0.72	D50
65562	100M	230	16	10	17	23.5	0.75	0.98	D50
65563	100T	230/400	16	10	17	23.5	0.75	1.02	D50
65564	150M	230	21.5	10	18	29	1.12	1.40	D63
65565	150T	230/400	21.5	10	18	29	1.12	1.40	D63
65566	200M	230	26	10	18	33.5	1.49	1.80	D63
65567	200T	230/400	26	10	18	33.5	1.49	1.80	D63
65569	300M	230	35	10	21	41	2.24	2.59	D75
65570	300T	230/400	35	10	21	41	2.24	2.40	D75

Maximum flow at Head of 4 m.c.w

PERFORMANCE

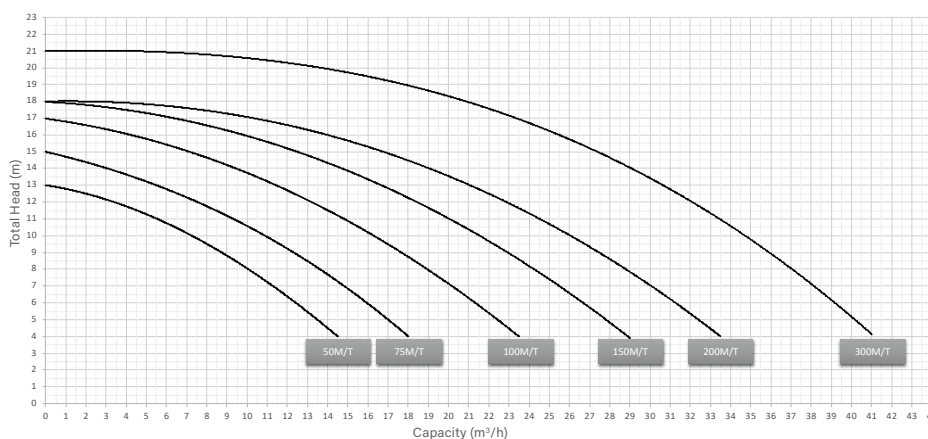

SELF-PRIMING PUMPS

Verdon ES



DESCRIPTION

Verdon ES is a wide range of self-priming pumps. Designed and produced to serve professional performance, to be reliable and with an exceptional value for money.

Ease of use and maintenance thanks to its large prefilter.

PVC accessories included in the pump.

	Code	Standard Pack	Standard weight in kg	Standard volume in m ³
Verdon ES 50M	73676	1	12	0.07
Verdon ES 75M	73678	1	13	0.07
Verdon ES 100M	73680	1	14	0.07
Verdon ES 100T	73681	1	14	0.07
Verdon ES 150M	73682	1	17	0.07
Verdon ES 150T	73683	1	17	0.07
Verdon ES 200M	73684	1	18	0.07
Verdon ES 200T	73685	1	19	0.07
Verdon ES 300M	73686	1	23	0.07
Verdon ES 300T	73687	1	19	0.07

TECHNICAL FEATURES

REF	MODEL	Voltage	Flow at H _N	Nominal Head	Maximum Head	Maximum Flow	Motor Rated Output	Maximum Absorbed Power	Pipe Size
		U _N	Q _N	H _N	H _{MAX.}	Q _{MAX.}	P _{2N}	P _{IMAX}	D
		V	m ³ /h	m	m	m ³ /h	kW	kW	mm
73676	50M	230	7	10	13.5	14.5	0.38	0.56	D50
73678	75M	230	10.5	10	14	18	0.56	0.73	D50
73680	100M	230	15.5	10	16	23	0.75	0.96	D50
73681	100T	230/400	15.5	10	16	23	0.75	0.96	D50
73682	150M	230	20.5	10	16	28	1.12	1.42	D63
73683	150T	230/400	20.5	10	16	28	1.12	1.35	D63
73684	200M	230	25	10	17	32.5	1.49	1.85	D63
73685	200T	230/400	25	10	17	32.5	1.49	1.85	D63
73686	300M	230	31	10	18	39	2.24	2.56	D75
73687	300T	230/400	31	10	18	39	2.24	2.35	D75

Maximum flow at Head of 4 m.c.w

PERFORMANCE

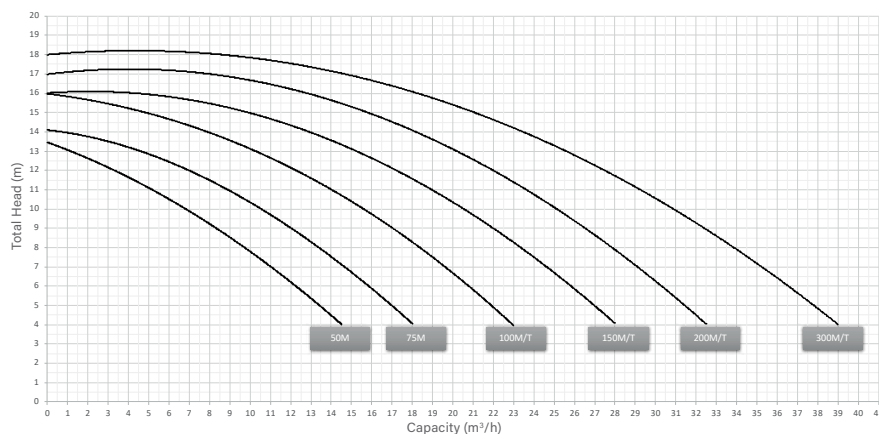

SENEXT XP SMALL SIZE. BIG PERFORMANCE.



SMALL-SIZED TO FIT EVERYWHERE.

As a result of its compact design, Senext XP pump reduces its footprint by 25%* and can fit even in the smallest technical rooms.

*Senext XP 100M compared to AstralPool Victoria Plus Silent 100M.



BIG PERFORMANCE.

Senext XP pump delivers 12%* improvement in hydraulic performance. It achieves higher efficiency and optimized flow by taking advantage of the new hydraulics and prefilter designs.

*Senext XP 100M compared to AstralPool Sena 100M.



EASY INSTALLATION AND MAINTENANCE.

Due to its retrofit platform and its specific fittings, Senext XP pump can be easily connected to any installation. Senext XP pump facilitates maintenance thanks to its tool-free easy-to-open pre-filter cap, its double water drainage for hibernation and its 2L-capacity pre-filter basket.

SELF-PRIMING PUMPS

Senext XP



- + Small-sized to fit everywhere
- + Big performance
- + Easy installation and maintenance

DESCRIPTION

Range of compact self-priming pumps with single-phase and three-phase motors. Engineered and built to perform outstandingly, for a long service with high reliability. The main characteristics of Senext XP are:

- **Small-sized to fit everywhere.** As a result of its compact design, its footprint is reduced by 25%¹ and can fit even in the smallest technical rooms.
- **Big performance.** Senext XP pump provides 12% improvement in hydraulic performance and 13%² in efficiency.
- **Easy installation.** Thanks to its retrofit platform and its specific fittings, this range of pumps can be easily connected to any installation
- **Easy maintenance.**
 - Extra large pre-filter basket of 2 liters
 - Tool-free easy-to-open prefilter cap
 - Double water drainage plug for hibernation

¹ Senext XP 100M compared to AstralPool Victoria Plus Silent pump

² Senext XP 100M compared to AstralPool Sena 100M



	Code	Standard Pack	Standard weight in kg	Standard volume in m ³
Senext XP 33M	71616	1	11.95	0.052
Senext XP 50M	71617	1	11.95	0.052
Senext XP 75M	71618	1	12.98	0.052
Senext XP 75T	71619	1	12.48	0.052
Senext XP 100M	71620	1	13.35	0.052
Senext XP 100T	71621	1	13.35	0.052
Senext XP 150M	71622	1	16.98	0.052
Senext XP 150T	71623	1	16.05	0.052

TECHNICAL FEATURES

REF	MODEL	Voltage	Flow at H _N	Nominal Head	Maximum Head	Maximum Flow	Motor Rated Output	Maximum Absorbed Power	Pipe Size
		U _N	Q _N	H _N	H _{MAX.}	Q _{MAX.}	P _{2N}	P _{IMAX}	D
		V	m ³ /h	m	m	m ³ /h	kW	kW	mm
71616	33M	230	5	8	10	10	0.38	0.35	D50
71617	50M	230	8.5	8	11	14	0.38	0.50	D50
71618	75M	230	12	8	14	17	0.56	0.65	D50
71619	75T	230/400	12	8	14	17	0.56	0.65	D50
71620	100M	230	15.5	8	17	20	0.75	0.88	D50
71621	100T	230/400	15.5	8	17	20	0.75	0.88	D50
71622	150M	230	21	8	20	25.5	1.12	1.30	D50
71623	150T	230/400	21	8	20	25.5	1.12	1.30	D50

Maximum flow at Head of 4 m.c.w

PERFORMANCE

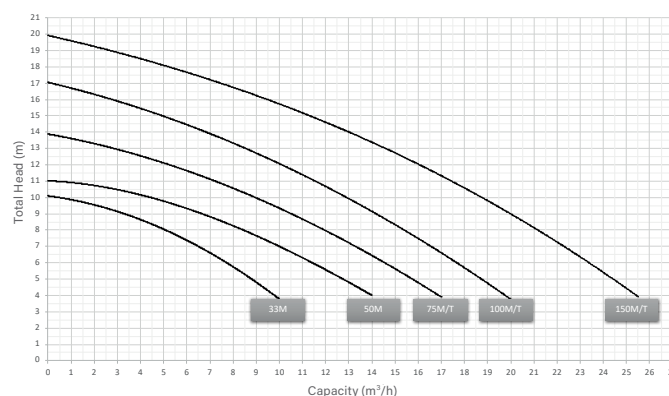

Sena



DESCRIPTION

A compact self-priming pump with single-phase and three-phase motors. GS marking. IP-55 protection rating, Class F insulation and AISI-316 stainless steel for all components in direct contact with water.



	Code	Standard Pack	Standard weight in kg	Standard volume in m ³
Sena 33M	25461	1	10.20	0.055
Sena 50M	25462	1	10.20	0.055
Sena 75M	25463	1	11.65	0.055
Sena 75T	25464	1	11.40	0.055
Sena 100M	25465	1	12.75	0.055
Sena 100T	25466	1	13.00	0.055
Sena 125M	25467	1	13.75	0.055
Sena 125T	25468	1	13.55	0.055

TECHNICAL FEATURES

REF	MODEL	Voltage	Flow at H _N	Nominal Head	Maximum Head	Maximum Flow	Motor Rated Output	Maximum Absorbed Power	Pipe Size
		U _N	Q _N	H _N	H _{MAX.}	Q _{MAX.}	P _{2N}	P _{IMAX}	D
		V	m ³ /h	m	m	m ³ /h	kW	kW	mm
25461	33M	230	3.5	8.0	9.0	9.3	0.25	0.46	D50
25462	50M	230	7.5	8.0	11.0	12.0	0.38	0.61	D50
25463	75M	230	11.2	8.0	13.0	15.3	0.56	0.91	D50
25464	75T	230/400	11.2	8.0	13.0	15.3	0.56	0.91	D50
25465	100M	230	13.8	8.0	14.5	17.3	0.75	1.14	D50
25466	100T	230/400	13.8	8.0	14.5	17.3	0.75	1.14	D50
25467	125M	230	16.0	8.0	16.5	19.5	0.94	1.19	D50
25468	125T	230/400	16.0	8.0	16.5	19.5	0.94	1.19	D50

Maximum flow at Head of 4 m.c.w

PERFORMANCE

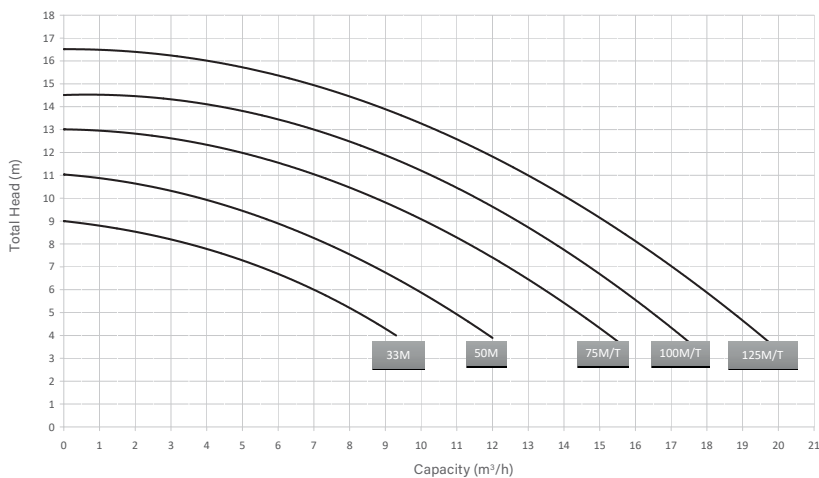

SELF-PRIMING PUMPS

Boise



DESCRIPTION

The Boise pump is designed to work under a vast range of conditions.

The Boise pump is built for ease of handling. It has a see-through lid for easy inspection and a large strainer to extend time between cleanings.

The motor materials are rustproof; the motor shaft is made from stainless steel and the sealed bearings never need lubrication. The thermoplastic housing withstands extreme heat and corrosion.

	Code	Standard Pack	Standard weight in kg	Standard volume in m ³
Boise 33M	71671	1	8.8	0.039
Boise 50M	71672	1	9.0	0.039
Boise 75M	71673	1	9.5	0.039
Boise 100M	71674	1	10.8	0.039
Boise 125M	71675	1	11.8	0.039

TECHNICAL FEATURES

REF	MODEL	Voltage	Flow at H _N	Nominal Head	Maximum Head	Maximum Flow	Motor Rated Output	Maximum Absorbed Power	Pipe Size
		U _N	Q _N	H _N	H _{MAX.}	Q _{MAX.}	P _{2N}	P _{IMAX}	D
		V	m ³ /h	m	m	m ³ /h	kW	kW	mm
71671	33M	230	6	8	11	10	0.21	0.36	D50
71672	50M	230	10.5	8	12.7	14.5	0.36	0.52	D50
71673	75M	230	12.5	8	13.8	15.5	0.55	0.77	D50
71674	100M	230	15.5	8	15	19.5	0.57	0.80	D50
71675	125M	230	19	8	16	22	0.73	1.00	D50

Maximum flow at Head of 4 m.c.w

PERFORMANCE

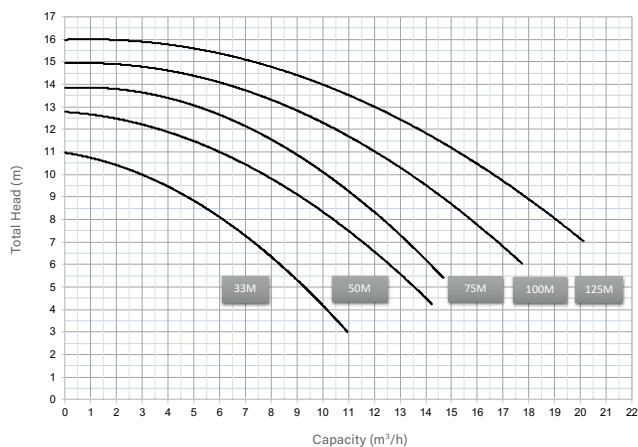

- IP-65 protection.
- Glass panel with lock and key.
- All units are compatible with:
 - 220/240V 1-phase (P+N+T) 50Hz/60Hz
 - 380/415V 3-phase (3P+N+T) 50Hz/60Hz
 - 220/230V 3-phase (3P+T) 50Hz/60Hz
- 24h programming clock with hourly programming.
- Connection for remote control of pump (on/off,...) and for auxiliary equipment (cold detector, level control...).
- All products supplied with:
 - Electrical diagram
 - Connection diagram
 - Instructions for installation
 - CE conformity certificate
 - Stuffing box at every cable entrance
 - Screws and plugs (4) for fixing to wall
- The control box model should be selected according to the nominal voltage of the pump:

TECHNICAL FEATURES

Type	Intensity range	Power Range 1-phase 230V	Power Range 3-phases 400V	Power Range 3-phases 230V
A	1.6A - 2.5A	¼ HP	¾ HP - 1 HP	½ HP
B	2.5A - 4A	½ HP	1.5 HP - 2 HP	¾ HP - 1 HP
C	4A - 6.3A	¾ HP - 1 HP	3 HP*	1.5 HP
D	6A - 10A	1.5 HP	4 HP**	2 HP - 3 HP

* Also 3.5 hp 400V 3~ in plastic (code 08003)

** Also 4.5 and 5.5 hp 400 V 3~ in plastic (codes 08004, 08005)



Complies with Standard EN 16582-1:2015

Control box for pump overload protection

DESCRIPTION

Thermal overload protection (1.6 to 10A), contactor, 24 hr programming clock, modular switch with 3 positions, Auto / 0 / Manual.

	Code	Standard Pack	Standard weight in kg	Standard volume in m ³
Type A	25717	1	1.9	0.014
Type B	25718	1	1.9	0.014
Type C	25719	1	1.9	0.014
Type D	25720	1	1.9	0.014

Control box for pump overload protection and underwater light

DESCRIPTION

Thermal overload protection (1.6 to 10A), contactor, 24 hr programming clock, modular switch with 3 positions: Auto / 0 / Manual.

	Code	Standard Pack	Standard weight in kg	Standard volume in m ³
Type A	25721	1	2.3	0.014
Type B	25722	1	2.3	0.014
Type C	25723	1	2.3	0.014
Type D	25724	1	2.3	0.014

CONTROL BOXES

Control box for pumps overload protection and underwater light with differential protection



DESCRIPTION

Thermal overload protection (1.6 to 10A), contactor, 24 hr programming clock. Three positions: Auto/0/manual. Protected 230 V 10 A output and controlled for underwater projectors. Single-phase.

	Code	Standard Pack	Standard weight in kg	Standard volume in m ³
Type A	25725	1	2.1	0.014
Type B	25726	1	2.1	0.014
Type C	25727	1	2.1	0.014
Type D	25728	1	2.1	0.014

Control box for pump overload protection and underwater light with differential protection



DESCRIPTION

Thermal overload protection (1.6 to 10A), contactor, 24 hr programming clock. Three positions: Auto/0/manual. Protected 230 V 10 A output and controlled for lights. Three phases. Three-phase.

	Code	Standard Pack	Standard weight in kg	Standard volume in m ³
Type A	25729	1	2.4	0.015
Type B	25730	1	2.4	0.015
Type C	25731	1	2.4	0.015
Type D	25732	1	2.4	0.015

Control box for pump overload protection and 1 set of LED underwater lights



DESCRIPTION

Control box for pump overload protection and 1 set of LED underwater lights. Thermal overload protection (1.6 to 10A), contactor, 24 hr programming clock. Three positions: Auto/0/manual. 12V 100VA. Protected output for 1 set of LED underwater lights.

	Code	Standard Pack	Standard weight in kg	Standard volume in m ³
Type A	74991	1	4.6	0.021
Type B	74992	1	4.6	0.021
Type C	74993	1	4.6	0.021
Type D	74994	1	4.6	0.021

Control box for pump overload protection and 1 underwater light



DESCRIPTION

Control box for pump overload protection and 1 underwater light.
Thermal overload protection (1.6 to 10A), contactor, 24 hr programming clock.
Three positions: Auto/0/manual. 12 V 315. Protected output for 1 underwater light.

	Code	Standard Pack	Standard weight in kg	Standard volume in m ³
Type A	69916	1	6	0.021
Type B	69917	1	6	0.021
Type C	69918	1	6	0.021
Type D	69919	1	6	0.021

Control box for pump overload protection and 2 underwater lights



DESCRIPTION

Thermal overload protection (1.6 to 10A), contactor, 24 hr programming clock.
Three positions: Auto/0/manual. 12 V 630. Protected output for 2 underwater lights.

	Code	Standard Pack	Standard weight in kg	Standard volume in m ³
Type A	69920	1	8	0.021
Type B	69921	1	8	0.021
Type C	69922	1	8	0.021
Type D	69923	1	8	0.021

Control box with overload protection for 2 pumps and control for 1 underwater light



DESCRIPTION

Circuit breaker protection (2 pumps of 1.6 at 10 A), contactor and 24 h timer. Three positions: Auto/0/manual.
Protected 230 V 10 A output for lights. Protected 12 V 315 VA output for 1 underwater light.

	Code	Standard Pack	Standard weight in kg	Standard volume in m ³
Type C + Type D	70429	1	7.5	0.024
Type D + Type D	70422	1	7.5	0.024



Control box with protection for 2 pumps and control for 2 underwater lights



DESCRIPTION

Thermal overload protection (1st pump: 4 poles, 10 A max. / 2nd pump: 2 poles, 10 A max.), contactor, 24 hr. programming clock, modular switch "Auto / 0 / Manual". Transformer 230/12 V -600VA for 2 underwater light of 300W.

	Code	Standard Pack	Standard weight in kg	Standard volume in m ³
Type C + Type D	70423	1	9.5	0.024
Type D + Type D	70424	1	9.5	0.024



Control box with protection for 1 pump and control for 3 underwater lights



DESCRIPTION

Thermal overload protection (4 poles, 10 A max.), contactor, 24 hr. programming clock, modular switch "Auto / 0 / Manual". Transformer 230/12 V -600VA + 300VA for 3 underwater light of 300W.

	Code	Standard Pack	Standard weight in kg	Standard volume in m ³
Type A	70425	1	10.4	0.024
Type B	70426	1	10.4	0.024
Type C	70427	1	10.4	0.024
Type D	70428	1	10.4	0.024



Encapsulated security transformer IP-65 for pool



DESCRIPTION

Manufactured according to the rules UNE-EN 61558 and directive CE.

- IP-657 housing protection degree.
- Transformer Class II. total protection against electric shock.
- Self-extinguishing housing IEC 695-2-1.
- Frequency 50/60 Hz.

	Code	Standard Pack	Standard weight in kg	Standard volume in m ³
130 VA from 220-240V to 12 V	35807	1	3.2	0.02
400 VA to 220-240V to 12-17 V	35385	1	6.8	0.04
800 VA from 220-240V to 12-17 V	35386	1	10.4	0.04

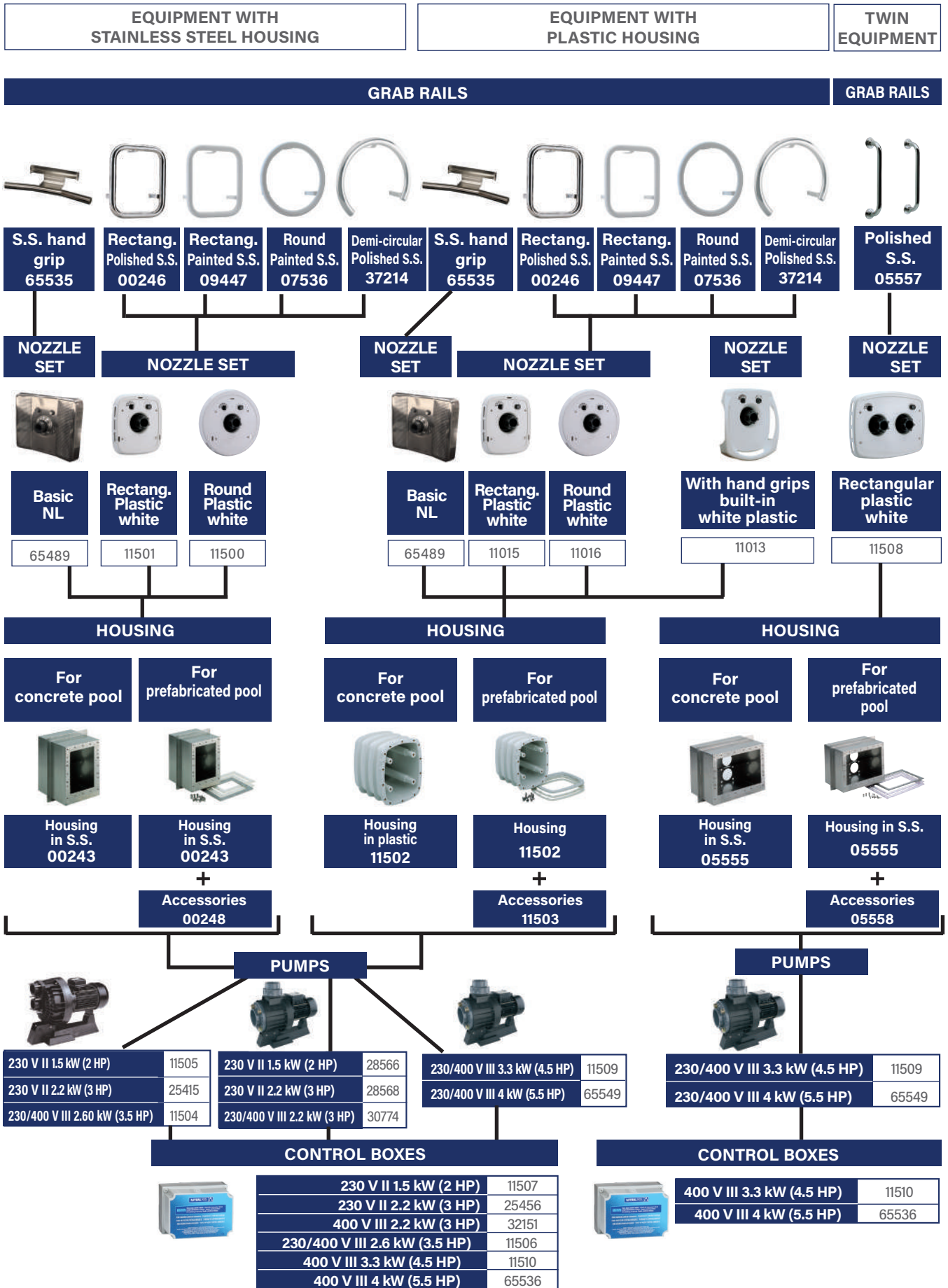

COUNTERCURRENT SWIMMING EQUIPMENT

Basic NL countercurrent nozzle set



DESCRIPTION

Countercurrent nozzle set in polished AISI-316L stainless steel front cover, interchangeable with nozzle sets 11499 and 11014, multi-directional water-air return nozzle, and suction capacity 60 m³/h, and on-off push button. Optional hand grip (code 65535).

	Code	Standard Pack	Standard weight in kg	Standard volume in m ³
Basic NL nozzle set for both stainless steel and plastic housing	65489	1	-	-



Basic ND countercurrent kit



DESCRIPTION

Countercurrent kit made up of:

- Return inlet (air-water) made of AISI-316 stainless steel.
- Illuminated ON-OFF piezoelectric push button made of AISI-316 stainless steel.
- Suction grille with a capacity of 60 m³/h made of polished AISI-316 stainless steel.
- 5.5 HP pump.
- Flow rate of 60 m³/h.
- Power control cabinet.

	Code	Standard Pack	Standard weight in kg	Standard volume in m ³
Basic ND unit for concrete pools	65498	1	-	-
Basic ND unit for liner pools	66044	1	-	-

Basic ND works only at 400 V III.



Advance ND countercurrent kit



DESCRIPTION

Countercurrent kit made up of:

- Return inlet (air-water) made of polished AISI-316 stainless steel.
- Illuminated ON-OFF and +/- piezoelectric push button made of AISI-316 stainless steel.
- Suction grille with a capacity of 60 m³/h made of polished AISI-316 stainless steel.
- 5.5 HP pump.
- Flow rate adjustable from 23 m³/h to 60 m³/h thanks to a variable-speed drive.
- Power control cabinet.

	Code	Standard Pack	Standard weight in kg	Standard volume in m ³
Advance ND unit for concrete pools	65497	1	-	-
Advance ND unit for liner pools	66043	1	-	-

Advance ND works only at 400 V III

For all products on this page



Complies with Standard
EN 13451-1-3



Complies with Standards
EN 16582-1
EN 16713-2

Nozzle assemblies with round front plate in white plastic



DESCRIPTION

Made up of: Front plate, nozzle assembly, on-off and air regulation remote control.
Components in AISI-316 stainless steel.

	Code	Standard Pack	Standard weight in kg	Standard volume in m ³
For stainless steel housing	11500	1	5.0	0.045
For plastic housing	11016	1	4.4	0.056

Nozzle assemblies with rectangular front plate in white plastic



DESCRIPTION

Made up of: Front plate, nozzle assembly, on-off and air regulation remote control.
Components in AISI-316 stainless steel.

	Code	Standard Pack	Standard weight in kg	Standard volume in m ³
For stainless steel housing	11501	1	5.0	0.045
For plastic housing	11015	1	3.9	0.039

Nozzle assemblies with rectangular front plate in white plastic and built-in hand grip



DESCRIPTION

Made up of: Front plate, nozzle assembly, on-off and air regulation remote control.

	Code	Standard Pack	Standard weight in kg	Standard volume in m ³
For plastic housing	11013	1	4.2	0.039

Front suction countercurrent unit hand grip



DESCRIPTION

Handrail made of AISI-316 stainless steel for assembly with Basic NL nozzle set (code 65489).

	Code	Standard Pack	Standard weight in kg	Standard volume in m ³
Hand grip	65535	1	-	-

For all products on this page



Complies with Standard
EN 13451-1-3



Complies with Standards
EN 16582-1
EN 16713-2

COUNTERCURRENT SWIMMING EQUIPMENT

Rectangular hand grips

in painted AISI-316L Stainless Steel



DESCRIPTION

Specially designed for 11015 & 11501 nozzles. Nevertheless can be mounted on any of the other nozzle sets except for the 11013.

Code	Standard Pack	Standard weight in kg	Standard volume in m ³
09447	1	1.4	0.013

Rectangular hand grips

in polished AISI-316L Stainless Steel



DESCRIPTION

Specially designed for 11015 and 11501 nozzles. Nevertheless can be mounted on any of the other nozzle sets except for the 11013.

Code	Standard Pack	Standard weight in kg	Standard volume in m ³
00246	1	1.48	0.01

Round Hand grips

in painted AISI-316L Stainless Steel



DESCRIPTION

Specially designed for 11016 & 11500 nozzles. Nevertheless can be mounted on any of the other nozzle sets except for the 11013.

Code	Standard Pack	Standard weight in kg	Standard volume in m ³
07536	1	1.6	0.02

Semicircular grab rail

in polished AISI-316L Stainless Steel



DESCRIPTION

AISI-316L polished stainless steel. Specially indicated for Marlin counter current swimming kit models; Marlin 30 II, Marlin 30 III and Marlin 45 III, although it may be mounted on any of the inlet sets, except for model 11013.

Code	Standard Pack	Standard weight in kg	Standard volume in m ³
37214	1	1.62	0.018

For all products on this page



Complies with Standard EN 13451-1-3



Complies with Standards EN 16582-1 EN 16713-2

Stainless Steel Housing

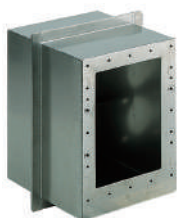

DESCRIPTION

In AISI-316L stainless steel. 240 mm in depth. Suitable for both, concrete and prefabricated pools. Supplied with sealing elements and 3 m cable conduit.

Code	Standard Pack	Standard weight in kg	Standard volume in m ³
00243	1	7.79	0.04

Accessory for fitting in liner and fibreglass pools

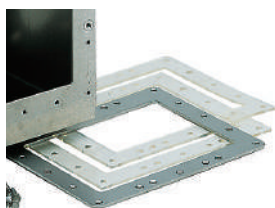

DESCRIPTION

In AISI-316L stainless steel, with seals and screws.

Code	Standard Pack	Standard weight in kg	Standard volume in m ³
00248	1	0.85	0.002

Housing



DESCRIPTION

Made in unalterable plastic. Supplied with sealing elements and two conduits of 3 m each.

Code	Standard Pack	Standard weight in kg	Standard volume in m ³
11502	1	5.0	0.036

Accessory for fitting in liner and fibreglass pools



DESCRIPTION

In plastic, with seals and screws.

Code	Standard Pack	Standard weight in kg	Standard volume in m ³
11503	1	0.6	0.003

Massage hose



DESCRIPTION

To be fitted on to the discharge nozzle. Length: 1.5 m.

Code	Standard Pack	Standard weight in kg	Standard volume in m ³
00247	1	1.22	0.01

Pumps



DESCRIPTION

Made of plastic. Double insulation motor shaft. IP-54 motor protection.

	Code	Standard Pack	Standard weight in kg	Standard volume in m ³
CCIH 200M	11505	1	27	0.098
CCIH 300M	25415	1	29	0.098
CCIH 350T	11504	1	30.5	0.098

PERFORMANCE

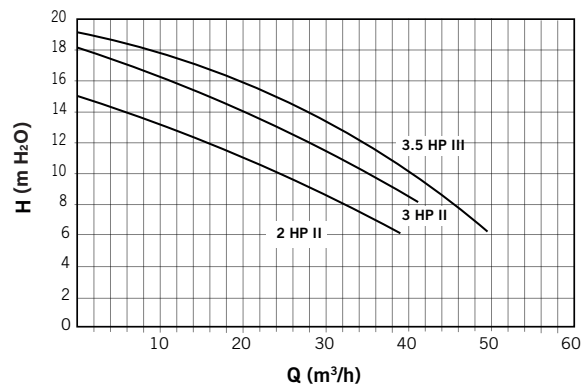

CCIV vertical drive pumps

DESCRIPTION

Specially designed for countercurrent equipment with high performance output with larger diameter of discharge and suction. It is important not to add any special features to the installation as they may limit the performance significantly. All the pumps metal components in contact with water are manufactured in AISI-316L Stainless Steel, highly resistant to corrosion.

	Code	Standard Pack	Standard weight in kg	Standard volume in m ³
CCIV 200M	28566	1	21.0	0.095
CCIV 300M	28568	1	22.6	0.095
CCIV 300T	30774	1	22.5	0.095
CCIV 550T	65549	1	-	-

PERFORMANCE

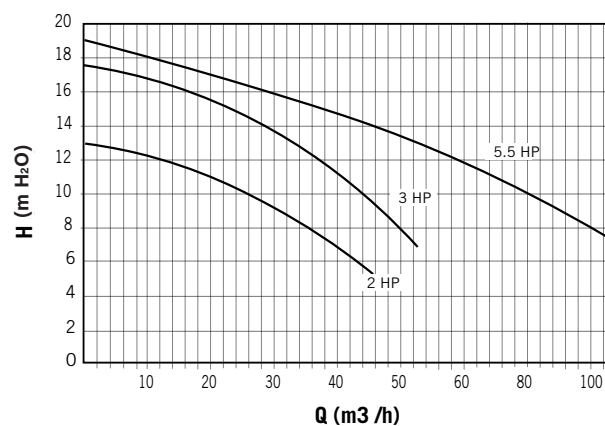

Control boxes



DESCRIPTION

Electro-pneumatic box. Pumps are operated through the nozzle faceplate buttons.

	Code	Standard Pack	Standard weight in kg	Standard volume in m ³
For 230 V II 1.5 kW (2 HP) pumps	11507	1	1.2	0.004
For 230 V II 2.2 kW (3 HP) pumps	25456	1	1.2	0.004
For 400 V III 2.2 kW (3 HP) pumps	32151	1	1.2	0.004
For 230/400 V III 2.6 kW (3.5 HP) pumps	11506	1	1.2	0.004
For 400 V III 4 kW (5.5 HP) pumps	65536	1	-	-

Nozzle assemblies

with rectangular front plate in white plastic



DESCRIPTION

Composed of: Faceplate, nozzle, On/OFF switch and air regulation knob. Components in AISI-316 Stainless Steel.

	Code	Standard Pack	Standard weight in kg	Standard volume in m ³
Nozzle assemblies	11508	1	7.0	0.065



Complies with Standard EN 13451-1-3



Complies with Standards EN 16582-1 EN 16713-2

Grab rails



DESCRIPTION

In AISI-316L Stainless Steel. (2 units).

	Code	Standard Pack	Standard weight in kg	Standard volume in m ³
Grab rails	05557	1	1.9	0.01



Complies with Standard EN 13451-1-3



Complies with Standards EN 16582-1 EN 16713-2

Twin Housing

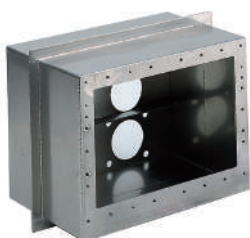

DESCRIPTION

In AISI-316L stainless steel. 240 mm in depth. Suitable for both, concrete and prefabricated pools. Supplied with sealing elements and 3 m cable conduit.

	Code	Standard Pack	Standard weight in kg	Standard volume in m ³
Twin Housing	05555	1	11.4	0.06

Accessory for mounting

in prefabricated and liner pools

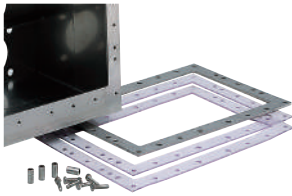

DESCRIPTION

In AISI-316L Stainless Steel. With gaskets and screws.

	Code	Standard Pack	Standard weight in kg	Standard volume in m ³
Accessory for mounting in prefabricated and liner pools	05558	1	1.35	0.01

Pumps



DESCRIPTION

Made of plastic. Double insulation motor shaft. IP-54 motor protection

	Code	Standard Pack	Standard weight in kg	Standard volume in m ³
CCIV 450T	11509	1	32.5	0.098

PERFORMANCE

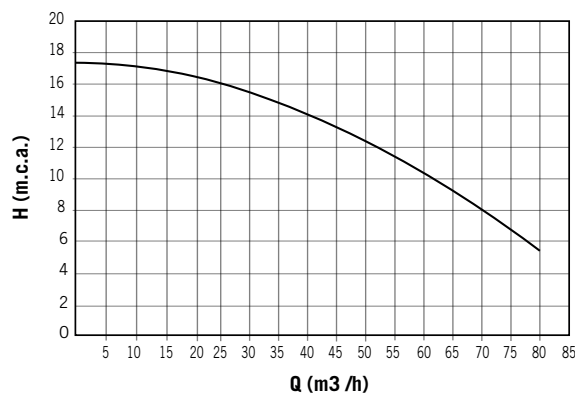

Control boxes



DESCRIPTION

Electro-pneumatic box. Pumps are operated through the nozzle faceplate buttons.

	Code	Standard Pack	Standard weight in kg	Standard volume in m ³
For 400 V III 3.3 kW (4.5 HP) pumps	11510	1	1.2	0.004

Marlin XS countercurrent

swimming equipment



DESCRIPTION

Set nozzle Mini Eco counter current unit. Highly competitive in its hydraulic performance. It can be installed in both concrete and prefabricated pools. Manufactured in white plastic parts. Consists of front panel nozzle set, stop/start push button and housing. Supplied with installation kit. Does not include pump or control box.

	Code	Standard Pack	Standard weight in kg	Standard volume in m ³
Marlin XS	45618	1	1.553	0.015

Marlin:

- + Inexpensive countercurrent swimming unit.
- + The innovative design and concept supplied as a kit (including face plate, housing, control box and pump) makes it a feature that will add significant value to your pool.
- + A highly competitive product thanks to its high performance hydraulic features, the Marlin countercurrent system is available in 3 models: the Marlin 30 II, the Marlin 30 III and the Marlin 45 III.
- + Grab rails and hydromassage hose may be added as optional features.

Marlin 30 II (single-phase)



DESCRIPTION

Consists of: Nozzle faceplate, plastic housing, control box and pump 2.2 kW (3 HP) 230 V II 50 Hz.

	Code	Standard Pack	Standard weight in kg	Standard volume in m ³
Marlin 30 II	35375	1	37.4	0.260

Marlin 30 III (three-phase)



DESCRIPTION

Consists of: Nozzle faceplate, plastic housing, control box and pump 2.2 kW (3 HP) 400 V III 50 Hz.

	Code	Standard Pack	Standard weight in kg	Standard volume in m ³
Marlin 30 III	35376	1	37.4	0.260

Marlin 45 III (three-phase)

DESCRIPTION

Consists of: Nozzle faceplate, plastic housing, control box and pump 3.3 kW (4.5 HP) 400 V III 50 Hz.

Part 11503 required for liner pools.

	Code	Standard Pack	Standard weight in kg	Standard volume in m ³
Marlin 45 III	35377	1	42.2	0.260

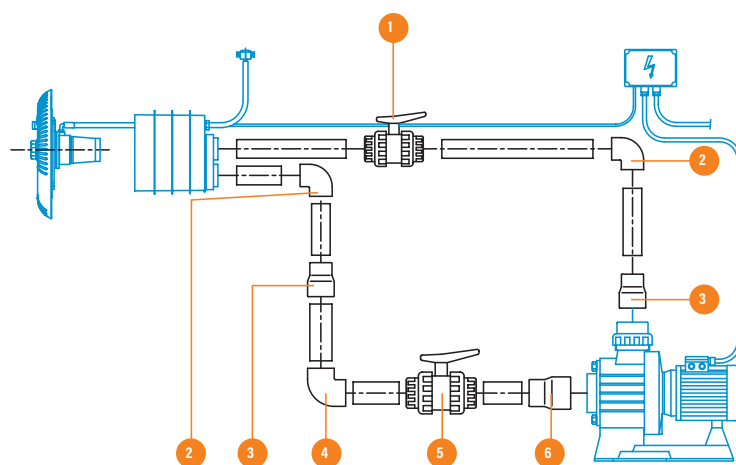
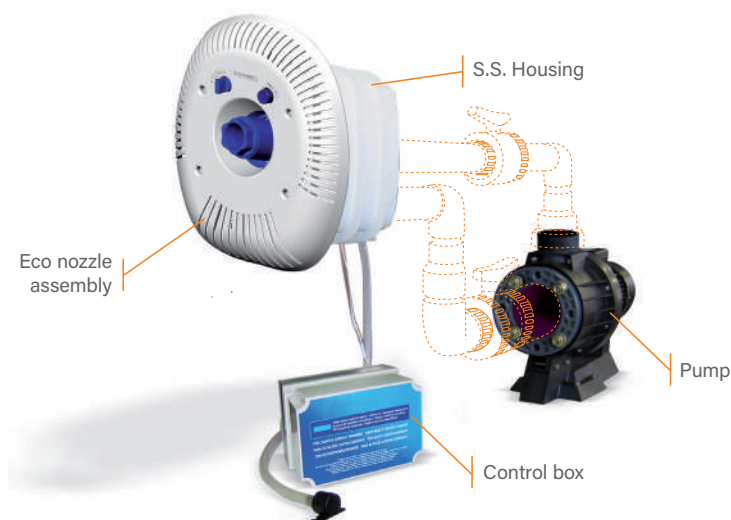

ACCESSORIES (NOT INCLUDED IN THE KIT)

Position	Quantity	Denomination	Code
1	1	PVC Ball valve Ø63 mm	02458
2	2	PVC elbow 90° Ø63 mm	01717
3	2	Conical reduction Ø90-75x63 mm	01993
4	1	PVC elbow 90° Ø75 mm	01718
5	1	PVC Ball valve Ø75 mm	02459
6	1	Conical reduction Ø110-90x75 mm	01997
-	-	PVC pipe Ø 63 mm PN-6	02692
-	-	PVC pipe Ø75 mm PN-6	02693



WATER TREATMENT PRODUCTS

ASTRALPOOL 

blueriiot

210 POOL CHEMICALS

- 211 Regulators
- 212 Disinfectants
- 214 Algicides
- 217 Flocculants
- 218 Cleaners
- 222 Winterising products
- 223 Kit

224 TESTERS

- 224 Blueriiot connected pool assistants
- 225 Blueriiot accessories
- 226 AstralPool water testers
- 231 Pocket gauges
- 232 Test kits and photometers

ctx[®]
pro

262 POOL CHEMICALS

- 262 Regulators
- 265 Disinfectants
- 274 Algicides
- 278 Flocculants
- 281 Cleaners
- 286 Maintenance Kit
- 287 Winterising products

YOUR POOL CARE STARTS HERE

New AstralPool range MAINTENANCE

THE 6 STEPS TO MAINTAIN YOUR POOL



- BALANCE** 1 adjust water parameters (pH and alkalinity)
- DISINFECTION** 2 add chlorine
- ALGICIDE** 3 algae prevention
- FLOCCULANT** 4 keep water clean and clear
- CLEANERS** 5 cleaning of pool elements
- WINTER CARE** 6 to maintain your pool in Winter



A GOOD MAINTENANCE IS THE BEST SOLUTION

However if something unexpected happens, RELAX!

- CLOUDY WATER?
- GREEN WATER OF ALGAE?
- ITCHY EYES AND SMELL OF CHLORINE?
- UNESTABLE PH?



New AstralPool range

SOLUTION













PREPARED FOR THE UNEXPECTED



Range
MAINTENANCE
or **SOLUTION**

Name + Product description

Product benefits

Formats	Duration Efficacy in the water	Type of pools	Dose Dose per m ³
 Granulate	 Immediate	 All pools	
 Tablets	 Daily	 pools with skimmer and sand filter	
 Liquid	 Recovery	 Special sand filter	
 Concentrated liquid		 Special liner	
 Powder		 Special tile	

For minimum amounts,
ask your dealer



Regulators

Solid pH Minor

DESCRIPTION

Solid pH reducer. For adjusting the pH to between 7.2 and 7.6.

	Format	Code	Standard Pack	Standard weight in kg	Standard volume in m ³
Square packaging	1.5 kg	11384	18	600	-
Square packaging	5 kg	74651	4	720	-

Solid pH Plus

DESCRIPTION

Solid pH enhancer. For adjusting the pH to between 7.2 and 7.6.

	Format	Code	Standard Pack	Standard weight in kg	Standard volume in m ³
Square packaging	1 kg	16538	18	400	-
Square packaging	5 kg	74896	4	720	-

Liquid pH Minor

DESCRIPTION

Liquid pH reducer. Ideal for dosing with a pump.

	Format	Code	Standard Pack	Standard weight in kg	Standard volume in m ³
Liquid pH Minor					
for professional use	10 l	43290	1	400	-
for professional use	20 l	73140	1	600	-
for end users	10 l	73664	1	400	-
for end users	20 l	73674	1	600	-

Liquid pH Plus

DESCRIPTION

Liquid pH enhancer. Ideal for dosing with a pump.

	Format	Code	Standard Pack	Standard weight in kg	Standard volume in m ³
	20 l	74863	1	600	-

Alkalinity enhancer

DESCRIPTION

Powder for increasing water alkalinity when it falls below 125 ppm.

	Format	Code	Standard Pack	Standard weight in kg	Standard volume in m ³
Square packaging	6 kg	15976	4	864	-

For minimum amounts,
ask your dealer



These new codes only affect
new formulas with low boric
(European legislation)



These new codes only affect
new formulas with low boric
(European legislation)

Disinfectants

Chlorine Shock granulate



DESCRIPTION

Dichloride granules with 55% free available chlorine.

	Format	Code	Standard Pack	Standard weight in kg	Standard volume in m ³
Square packaging	1 kg	11393	18	400	-
Square packaging	5 kg	11394	4	720	-

Chlorine Shock 30g tablets



DESCRIPTION

Trichloride 30-g tablets with 50% free available chlorine.

	Format	Code	Standard Pack	Standard weight in kg	Standard volume in m ³
Square packaging	1 kg	75156	18	400	-
Square packaging	5 kg	75157	4	720	-

Chlorine Lent granulate



DESCRIPTION

Trichloride granules with 90% free available chlorine.

	Format	Code	Standard Pack	Standard weight in kg	Standard volume in m ³
Square packaging	1 kg	11404	18	400	-
Square packaging	5 kg	11405	4	720	-
	30 kg	11406	1	540	-

Chlorine Lent 250g tablets



DESCRIPTION

Slow-dissolving 250-g trichloride blocks with 90% free available chlorine.

	Format	Code	Standard Pack	Standard weight in kg	Standard volume in m ³
Square packaging	5 kg	75162	4	720	-
	25 kg	75163	1	450	-

The transition to the new brand's visuals may take some time. It is possible to get products with visuals which have not yet been updated.

For minimum amounts,
ask your dealer

Disinfectants



Action 10



These new codes only affect
new formulas with low boric
(European legislation)

DESCRIPTION

250-g multipurpose tablets that perform the functions of the following 10 products: disinfectant, algicide, bactericide, algaestat, virucide, fungicide, flocculant-coagulant, pH reducer, stabilizer and descaler.

	Format	Code	Standard Pack	Standard weight in kg	Standard volume in m ³
Square packaging	5 kg	75158	4	720	-

Multi-action granules



DESCRIPTION

Granules that act as a bactericide, algicide and flocculant.



	Format	Code	Standard Pack	Standard weight in kg	Standard volume in m ³
	1 kg	15983	18	400	-
	5 kg	15984	4	480	-
	30 kg	15985	1	540	-

Multi-action 250-g tablet



DESCRIPTION

Slow-dissolving, 250-g tablet that acts as an algicide, bactericide and flocculant.



	Format	Code	Standard Pack	Standard weight in kg	Standard volume in m ³
Square packaging	1 kg	75159	18	540	-
Square packaging	5 kg	75160	4	720	-
	25 kg	75161	1	450	-

These new codes only affect
new formulas with low boric
(European legislation)

Special multi-purpose tablet for hard water



DESCRIPTION

Solid compound in tablet form, specially formulated so that a single dose will remove bacteria, viruses and microorganisms from pool water, which prevents algae from growing, limescale from forming and keeps the water crystal clear.

	Format	Code	Standard Pack	Standard weight in kg	Standard volume in m ³
	5 kg	75154	4	720	-
	25 kg	75155	1	450	-

These new codes only affect
new formulas with low boric
(European legislation)

For minimum amounts,
ask your dealer



Disinfectants

Bromine tablets



DESCRIPTION

Slow-dissolving 20-g bromine tablets for the continuous disinfection of pools and spas. Does not smell of chlorine. High tolerance to pH levels. Powerful disinfectant and oxidising agent.

Format	Code	Standard Pack	Standard weight in kg	Standard volume in m ³
5 kg	16550	4	400	-
20 kg	28740	1	540	-

Chlorine stabilizer



DESCRIPTION

Prevents the rapid breakdown of chlorine by the sun's UV rays.

Format	Code	Standard Pack	Standard weight in kg	Standard volume in m ³
4,5 kg	72812	4	480	-

Chlorine and bromine neutralizer



DESCRIPTION

For the removal of excess residual chlorine or bromine.

Format	Code	Standard Pack	Standard weight in kg	Standard volume in m ³
6 kg	16578	4	576	-

Algicides

Algicide



DESCRIPTION

Prevents the formation of algae in pools.

Format	Code	Standard Pack	Standard weight in kg	Standard volume in m ³
5 l	11417	1	600	-
25 l	11418	1	600	-

The transition to the new brand's visuals may take some time. It is possible to get products with visuals which have not yet been updated.

For minimum amounts,
ask your dealer



Instantly removes what
algae feed on.

Concentrated product:
lasts for 13 weeks*

* 80 ml a week for a 50 m³ pool.



64291

Algicides

Algicide with brightener



DESCRIPTION

A powerful bactericide, algicide and fungicide.

Format	Code	Standard Pack	Standard weight in kg	Standard volume in m ³
5 l	11414	4	640	-
25 l	11415	1	600	-

Algicide Extra



DESCRIPTION

Highly efficient non-foaming algicide that also acts as a flocculant.

Format	Code	Standard Pack	Standard weight in kg	Standard volume in m ³
5 l	24616	4	640	-
25 l	11423	1	600	-

PhosFree



DESCRIPTION

Concentrated product that prevents the formation of algae as a result of chemicals, garden fertilizers and other contaminating agents. It removes the phosphates on which algae feed, thus inhibiting their growth.

Suitable for use in all types of pools, filters and disinfection treatment systems.

- Is easy to use.
- Improves the performance of salt chlorinators.

Recommended use:

The concentration of phosphates should be kept below 125 ppb (parts per billion) to prevent the formation of algae.

Initial treatment for high phosphate levels:

1. Ensure the filter is clean and that the system is working properly.
2. Pour the required concentration of PhosFree in a container with water and spread the solution evenly across the surface of the pool.
3. Keep the filtration system running for at least 24 hours following application.
4. Test the phosphate level of your pool using a phosphate test kit 48 hours later. If necessary, repeat the treatment.

Format	Code	Standard Pack	Standard weight in kg	Standard volume in m ³
PhosFree 1 l	65957	12	480	-
Phosphate test strips 25 strips	64291	12	-	-

TECHNICAL FEATURES

For a 50 m ³ pool				
Phosphate level of the pool	250 ppb	500 ppb	1000 ppb	1500 ppb
Phosfree ml	150	300	600	900

The transition to the new brand's visuals may take some time. It is possible to get products with visuals which have not yet been updated.

For minimum amounts,
ask your dealer

Algicides

Algicide Power



More power in each
drop!

Concentrated product:
25 weeks (1 l)

DESCRIPTION

A fast-acting compound formulated from surfactants that displays great properties as an algicide and fungicide, which therefore prevents the formation and growth of algae in pool water.

Prevention is better than cure:

Concentrated maintenance product that keeps pools free of all types of algae thanks to its powerful properties.

The revolutionary dosing cap will enable you to add exactly the amount of the product you need, thus helping you to make savings and use it more efficiently.

Format	Code	Standard Pack	Standard weight in kg	Standard volume in m ³
1 l	63124	12	480	-

Algicide Power Plus



Non-foaming.

Concentrated product:
20 weeks (1 l)

DESCRIPTION

An extra strong, fast-acting algicide with micro-flocculant properties that makes it better able to prevent the appearance of algae that live suspended in the water. Non-foaming.

Concentrated maintenance product that keeps pools free of all types of algae thanks to its powerful properties.

The revolutionary dosing cap will enable you to add exactly the amount of the product you need, thus helping you to make savings and use it more efficiently.

Format	Code	Standard Pack	Standard weight in kg	Standard volume in m ³
1 l	63126	12	480	-

AlgiStop



DESCRIPTION

Antialgae concentrated recovery, removes all kinds of algae, even black. Fast-acting, recommended even for liner and polyester pools (does not stain).

Format	Code	Standard Pack	Standard weight in kg	Standard volume in m ³
1 l	72824	5 l	640	-

The transition to the new brand's visuals may take some time. It is possible to get products with visuals which have not yet been updated.

For minimum amounts,
ask your dealer



The natural way to
make water clean and
transparent.

Concentrated product:
25 weeks (1 l)

* 40 ml a week for a 50 m³ pool.

Flocculants

Natural Flocculant



DESCRIPTION

This natural clarifier made from chitosan (crustacean shells) is the most effective weekly treatment for preventing the formation of foam and cloudiness in pool water. It removes all traces of body oils and lotions, as well as excess metal precipitates.

Suitable for use in all types of pools and filters.

- Keeps water crystal clear, which helps the filter collect dirt.
- Removes excess metal precipitates.
- Helps make cleaning filters quicker and easier.
- Improves the performance of salt chlorinators.

Recommended use:

To keep your pool water crystal clear, treat it with the recommended dose of Natural Clarifier once a week. For home pools that are used a lot or for public pools, treat the pool water with twice or three times the recommended dose.

Format	Code	Standard Pack	Standard weight in kg	Standard volume in m ³
1 l	65956	12	480	-

CrystalBlock - Single dose gel flocculant



DESCRIPTION

The easiest way to enjoy crystal clear water. No handling or complicated dosing systems required. It has never been easier to enjoy crystal clear water. Ideal for all pool types, except ones with cartridge or diatomaceous earth filters.

The single dose gel blocks will enable you to add the exact amount of the product with next to no effort. CrystalBlock collects colloidal particles and algae spores so that they are filtered better.

- Increases filter efficiency.
- Helps keep your pool water crystal clear.
- Improves the efficiency of disinfectants.

Format	Code	Standard Pack	Standard weight in kg	Standard volume in m ³
36 UN	67558	72	10.800	-

Liquid flocculant



DESCRIPTION

Clarifies water by eliminating the colloidal particles that cause cloudiness in water.

Format	Code	Standard Pack	Standard weight in kg	Standard volume in m ³
5 l	11388	4	640	-
25 l	11389	1	600	-



For minimum amounts,
ask your dealer



Flocculants

Solid flocculant



DESCRIPTION

Long-lasting improvement of water transparency through permanent flocculation.

	Format	Code	Standard Pack	Standard weight in kg	Standard volume in m ³
	1 kg of product in 8 bags (8 bags of 125 g each)	11390	14	490	-

Claritab Plus



DESCRIPTION

Super concentrated dual action coagulant and flocculant tablets, specially formulated to obtain the best performance from sand filters. The slow dissolving and controlled action completely removes suspended particles in the water (metal ions, organic matter, etc.). Savings are made as fewer disinfectants are used.

	Format	Code	Standard Pack	Standard weight in kg	Standard volume in m ³
	Display 20 units Unit: 5 x 20 g	72769	24	960	-

Cleaners

Surface cleaner



DESCRIPTION

Extra strong descaler. Acid.

	Format	Code	Standard Pack	Standard weight in kg	Standard volume in m ³
	5 l	11391	4	640	-
	25 l	11392	1	600	-

Surface cleaner

for polyester and fibreglass pools



DESCRIPTION

It combats limescale and grease without damaging pool lining.

	Format	Code	Standard Pack	Standard weight in kg	Standard volume in m ³
	5 l	16558	4	640	-

The transition to the new brand's visuals may take some time. It is possible to get products with visuals which have not yet been updated.

For minimum amounts,
ask your dealer

Cleaners



Gelamin



DESCRIPTION

Gel descaler for pool walls and floors. Highly effective. Easy to use.

Format	Code	Standard Pack	Standard weight in kg	Standard volume in m ³
5 l	15987	4	640	-



Water line degreaser Non-foaming



DESCRIPTION

A specially formulated compound for removing scum and dirt from pool edges and walls, and areas around them that may require cleaning.

Format	Code	Standard Pack	Standard weight in kg	Standard volume in m ³
5 l	11426	4	640	-
25 l	11427	1	600	-



Netoline Water line



DESCRIPTION

Powerful liquid descaler with degreasing properties for cleaning the water line.

Format	Code	Standard Pack	Standard weight in kg	Standard volume in m ³
1 l	40931	12	480	-
5 l	40932	4	640	-
25 l	40934	1	600	-



Liquid Filnet



DESCRIPTION

Liquid descaler specially designed for cleaning the inside of sand filters in public pools.

Format	Code	Standard Pack	Standard weight in kg	Standard volume in m ³
5 l	73557	4	640	-
25 l	73558	1	600	-



The transition to the new brand's visuals may take some time. It is possible to get products with visuals which have not yet been updated.

For minimum amounts,
ask your dealer

Cleaners

Solid Filnet



DESCRIPTION

A solid descaler for cleaning the inside of sand filters.

Format	Code	Standard Pack	Standard weight in kg	Standard volume in m ³
1 kg	15988	18	540	-

Step 1 Polisher



DESCRIPTION

Stainless steel polisher and rust remover.

Format	Code	Standard Pack	Standard weight in kg	Standard volume in m ³
750 ml	72847	12	432	-

Step 2 Brightener



DESCRIPTION

Product designed to care and polish stainless steel.

Format	Code	Standard Pack	Standard weight in kg	Standard volume in m ³
750 ml	72848	12	432	-

Stainless steel cleaner-polish



DESCRIPTION

Stainless steel cleaner-polish. It removes stains and degreases all types of stainless steel surfaces.

Format	Code	Standard Pack	Standard weight in kg	Standard volume in m ³
1 l	72845*	12	480	-
5 l	72846*	4	640	-

* New codes replace old codes 18713 and 16630.

The transition to the new brand's visuals may take some time. It is possible to get products with visuals which have not yet been updated.

For minimum amounts,
ask your dealer



Cleaners

Surf-Clean



DESCRIPTION

Surface sanitizer with a pleasant pine smell for all kinds of surfaces.

Format	Code	Standard Pack	Standard weight in kg	Standard volume in m ³
1 l	73666	9	432	-
5 l	73667	4	720	-
25 l	73668	1	450	-

Descaler



DESCRIPTION

Prevents limescale.

Format	Code	Standard Pack	Standard weight in kg	Standard volume in m ³
5 l	11431	4	640	-



Super descaler



DESCRIPTION

Highly efficient descaler. Prevents the precipitation of lime and the build-up of limescale. Prevents pipes from getting blocked.

Format	Code	Standard Pack	Standard weight in kg	Standard volume in m ³
5 l	16555	4	640	-



The transition to the new brand's visuals may take some time. It is possible to get products with visuals which have not yet been updated.

For minimum amounts,
ask your dealer

Winterising products

Winterizer



DESCRIPTION

Prevents the proliferation of algae and bacteria in the water. Prevents water from going stagnant and the build-up of limescale. Takes the strain out of spring cleaning. Non-foaming.

Format	Code	Standard Pack	Standard weight in kg	Standard volume in m ³
5 l	11430	4	640	-

Winterizer copper free



DESCRIPTION

Prevents water putrefaction and slows the growth of algae and bacteria. Compatible with all treatments. Including the PHMB.

Format	Code	Standard Pack	Standard weight in kg	Standard volume in m ³
5 l	16553	4	640	-

More power in each drop!

Concentrated product:
0,5 L / 40 - 50 m³

Winterizer Power



DESCRIPTION

Concentrated winterizer specially formulated for liner and polyester pools that will enable you to keep your pool water in top condition during winter as it prevents the formation of algae and bacteria. Saves water as it can be used from one season to the next.

The revolutionary dosing cap will enable you to add exactly the amount of the product you need, thus helping you to make savings and use it more efficiently.

At the end of the bathing season before ending regular maintenance treatment, a super-chlorination should be performed using dichlor granules.

It is advisable to repeat the process halfway through the winter season.

Format	Code	Standard Pack	Standard weight in kg	Standard volume in m ³
1 l	63165	12	480	-

More power in each drop!

Concentrated product:
0,5 L / 40 - 50 m³

The transition to the new brand's visuals may take some time. It is possible to get products with visuals which have not yet been updated.

For minimum amounts,
ask your dealer

Winterising products

Inverlong



These new codes only affect
new formulas with low boric
(European legislation)

DESCRIPTION

Full treatment for pools in winter. Prevents the water from going stagnant and the proliferation of algae. Keeps the water crystal clear. Acts as a bactericide, algicide and flocculant. Comes with a floating dispenser.

Format	Code	Standard Pack	Standard weight in kg	Standard volume in m ³
1.75 kg	75151	8	128	-

Kit

KIT-Splash



DESCRIPTION

Children's pool maintenance kit. It contains 0.5 l of dichlor granules and 0.5 l of concentrated algicide.

Format	Code	Standard Pack	Standard weight in kg	Standard volume in m ³
Kit	15986	14	294	-

Blueriiot connected pool assistants



Blue Check

DESCRIPTION

Smart test strips (50 strips) that can be used with Blueriiot app to get advices to better treat the pool.

- pH.
- Free chlorine.
- Bromine.
- Total alkalinity.
- Total hardness.
- Cyanuric acid.
- Blueriiot Pool & spa Assistant free app.

Code	Standard Pack	Standard weight in kg	Standard volume in m ³
71664*	1	-	-
71665*	1	-	-

*71664 : Packaging in English, French, Dutch and German.

*71665 : Packaging in English, Spanish, Italian and Portuguese.

Blue Connect GO



DESCRIPTION

The smart connected pool assistant to get essential water parameters and advices using the Blueriiot app.

- Temperature.
- pH.
- ORP (platinum sensor for use with fresh water).
- Works with Bluetooth & Sigfox (remote access from anywhere).
- Blueriiot Pool & spa Assistant free app.
- Compatible with chlorine and bromine pools and spas. Not compatible with salt chlorinator pools and spas.
- Blueriiot Premium available upon subscription (monthly or yearly).

Code	Standard Pack	Standard weight in kg	Standard volume in m ³
73014	1	-	-

Blue Connect Plus



DESCRIPTION

The smart connected pool assistant to get all water parameters and premium advices using the Blueriiot app.

- Temperature.
- pH.
- ORP (gold sensor for uses with fresh and salt water).
- Conductivity (Salinity).
- Works with Bluetooth & Sigfox (remote access from anywhere).
- Up to 20 automatical measurements.
- Blueriiot Pool & spa Assistant free app.
- Blueriiot Premium lifetime included.
- Blue Fit50.
- Virtual Pool Care (pools management portal for pool pros) lifetime included.
- Compatible with chlorine, bromine and salt chlorinator pools and spas.

Code	Standard Pack	Standard weight in kg	Standard volume in m ³
71663	1	-	-

The transition to the new brand's visuals may take some time. It is possible to get products with visuals which have not yet been updated.

Blueriiot accessories



Fit

blueriiot

DESCRIPTION

50 mm tapping saddle. For in-line installation onto plumbing (better integration and more accurate reading).

	Code	Standard Pack	Standard weight in kg	Standard volume in m ³
50 mm tapping saddle	7015C002	1	-	-

Calibration Kit

blueriiot



DESCRIPTION

For Blue Connect sensor's calibration. The calibration is recommended once a year depending of the usage.

- 2 x 20ml packets of pH4.
- 2 x 20ml packets of pH7.
- 2 x 20ml packets of ORP 468 mV.

	Code	Standard Pack	Standard weight in kg	Standard volume in m ³
	71666	6	-	-

Battery

blueriiot



DESCRIPTION

Battery for Blue Connect.

	Code	Standard Pack	Standard weight in kg	Standard volume in m ³
	7015C001	1	-	-

Sensor

blueriiot



DESCRIPTION

Sensors for Blue Connect:

- 3-in-1 sensor Pt : Compatible with chlorine, bromine pools and spas.
- 4-in-1 sensor Au : compatible with chlorine, bromine and salt pools and spas.

	Code	Standard Pack	Standard weight in kg	Standard volume in m ³
4-in-1 sensor Au	7015R002	1	-	-
3-in-1 sensor Pt	7015R003	1	-	-

Extender

blueriiot



DESCRIPTION

Wi-Fi bridge. With Blue Extender, use Blue Connect with a Wi-Fi network.

	Code	Standard Pack	Standard weight in kg	Standard volume in m ³
	7015C004	1	-	-

The transition to the new brand's visuals may take some time. It is possible to get products with visuals which have not yet been updated.

AstralPool water testers



3-in-1 test strips



DESCRIPTION

Quick and easy test for free chlorine, pH and alkalinity. Contains 50 strips.

Code	Standard Pack	Standard weight in kg	Standard volume in m ³
41925	10	0.6	0.005



6-in-1 test strips



DESCRIPTION

Quick and easy test for free chlorine, pH, alkalinity, bromine, water hardness and cyanuric acid. Contains 50 strips.

Code	Standard Pack	Standard weight in kg	Standard volume in m ³
45198	10	0.6	0.005



Reagent refills



DESCRIPTION

1 OTO and 1 phenol refill.

Code	Standard Pack	Standard weight in kg	Standard volume in m ³
38638	144	8	0.037



Basic pH and chlorine test kit

Basic Line



DESCRIPTION

With OTO and phenol.

Code	Standard Pack	Standard weight in kg	Standard volume in m ³
38637	48	8	0.054

AstralPool water testers



Total chlorine and pH comparison test kit



DESCRIPTION

Comes in a modern, practical design. Packaged in a blue plastic box. Comes with OTO and liquid phenol.

	Code	Standard Pack	Standard weight in kg	Standard volume in m ³
	25353	25	4.8	0.019



Chlorine, bromine and pH comparison test kit



DESCRIPTION

Comes in a modern, practical design. Packaged in a blue plastic box. Comes with phenol and DPD tablets.

	Code	Standard Pack	Standard weight in kg	Standard volume in m ³
	26155	25	4.8	0.019



Liquid active oxygen tester



DESCRIPTION

For testing the residual liquid active oxygen in the water.

	Code	Standard Pack	Standard weight in kg	Standard volume in m ³
	26082	1	15.4	0.0265



28050



28051

Reagent refills



	Format	Code	Standard Pack	Standard weight in kg	Standard volume in m ³
OTO refill	15 cm ³	28050	50	2.1	0.020
Phenol refill	15 cm ³	28051	50	2.1	0.020
OTO refill	250 cm ³	16623	20	5.5	0.010
Phenol refill	250 cm ³	16624	20	5.5	0.010
1 OTO and 1 phenol refill	15 cm ³	16610	50	3.5	0.020



16623



16610

The transition to the new brand's visuals may take some time. It is possible to get products with visuals which have not yet been updated.

AstralPool water testers



Free chlorine and pH Pooltester



	Code	Standard Pack	Standard weight in kg	Standard volume in m ³
Chlorine range: 0.1-3.0 mg/l pH range: 6.8-8.2	03253	12	2.2	0.007
Chlorine range: 0.5-6.0 mg/l pH range: 6.8-8.2	01419	12	2.2	0.007



Oxygen and pH Pooltester



	Code	Standard Pack	Standard weight in kg	Standard volume in m ³
	03182	12	2.2	0.007



Bromine and pH Pooltester



	Code	Standard Pack	Standard weight in kg	Standard volume in m ³
	16374	12	2.2	0.007



Copper test kit



	Code	Standard Pack	Standard weight in kg	Standard volume in m ³
	03258	1	0.2	0.004



Pooltester refill blister pack



DESCRIPTION

20 DPD-1 tablets and 20 red phenol tablets.

	Code	Standard Pack	Standard weight in kg	Standard volume in m ³
	18854	30	1.4	0.010

The transition to the new brand's visuals may take some time. It is possible to get products with visuals which have not yet been updated.

TESTERS

AstralPool water testers



Except for codes 43409 and 43408

Reagent tablets



	Format	Code	Standard Pack	Standard weight in kg	Standard volume in m ³
Phenol reagent tablets (pH)	250 units	01426	1	0.1	0.004
DPD-1 reagent tablets	250 units	01424	1	0.1	0.004
DPD-2 reagent tablets	250 units	43409	1	0.1	0.004
DPD-3 reagent tablets	250 units	01425	1	0.1	0.004
DPD-4 reagent tablets	250 units	43408	1	0.1	0.004
MPS-OUT reagent tablets (test for the amount of chlorine in the presence of Oximines)	250 units	08677	1	0.1	0.004

3-in-1 test strips: MPS



DESCRIPTION

Tests for potassium monopersulphate, pH and total alkalinity. Each pack contains 50 strips.

	Code	Standard Pack	Standard weight in kg	Standard volume in m ³
	57500	-	-	-

4-in-1 test strips: free chlorine



DESCRIPTION

Quick and easy test for free chlorine, pH and total alkalinity in pools treated with chlorine. Each pack contains 50 strips.

	Code	Standard Pack	Standard weight in kg	Standard volume in m ³
	11732	-	-	-

4-in-1 test strips: bromine



DESCRIPTION

Quick and easy test for bromine, pH and total alkalinity in pools treated with bromine. Each pack contains 50 strips.

	Code	Standard Pack	Standard weight in kg	Standard volume in m ³
	54467	-	-	-

The transition to the new brand's visuals may take some time. It is possible to get products with visuals which have not yet been updated.

AstralPool water testers

Salt test kit



DESCRIPTION

Salt test strips for checking salt levels. Salt levels must be checked on a regular basis as the water is renewed.

Code	Standard Pack	Standard weight in kg	Standard volume in m ³
07937	-	-	-

TruTest test strips



DESCRIPTION

50 TruTest 3-in-1 test strips (test for free chlorine and bromine, pH and total alkalinity).

Code	Standard Pack	Standard weight in kg	Standard volume in m ³
40817	-	-	-

Digital test strip reader



DESCRIPTION

Digital test strip reader for measuring total free chlorine/bromine, pH and alkalinity. It combines the simplicity and accuracy of test strips with advanced digital technology. You will no longer have to guess the exact results of test strips. Just wet a test strip in your pool or spa water, put it in the reader and you will obtain fast, accurate results.

Code	Standard Pack	Standard weight in kg	Standard volume in m ³
38813	-	-	-

TruTest kit



DESCRIPTION

Comes with:

- 1 display rack and banner for your point of sale.
- 6 digital test strip readers.
- 6 packs of TruTest digital test strips.

Code	Standard Pack	Standard weight in kg	Standard volume in m ³
41653	-	-	-

The transition to the new brand's visuals may take some time. It is possible to get products with visuals which have not yet been updated.

Pocket gauges



Dissolved solids pocket gauge

DESCRIPTION

A small, practical pocket gauge for quickly measuring the solids dissolved in the water.

	Code	Standard Pack	Standard weight in kg	Standard volume in m ³
	41928	1	-	-



Redox pocket gauge

DESCRIPTION

A small, practical pocket gauge for quickly measuring the redox level in pool water.

	Code	Standard Pack	Standard weight in kg	Standard volume in m ³
	28583	1	-	-



pH pocket gauge

DESCRIPTION

A small, practical pocket gauge for quickly measuring the pH level in pool water.

	Code	Standard Pack	Standard weight in kg	Standard volume in m ³
	43447	1	-	-



Conductivity pocket gauge

DESCRIPTION

A small, practical pocket gauge for quickly measuring conductivity.

	Code	Standard Pack	Standard weight in kg	Standard volume in m ³
Range: 0.1-19.9 mS/cm.	43428	1	-	-

Test kits and photometers

3-in-1 photometer



DESCRIPTION

- Chlorine: 0.01-5.0 mg/l
- Isocyanuric acid 2-200 mg/l
- pH: 6.8 - 8.4

Code	Standard Pack	Standard weight in kg	Standard volume in m ³
47189	1	1.0	0.049

6-in-1 photometer



DESCRIPTION

- Chlorine range: 0.01-5.0 mg/l
- ph range: 6.8-8.4
- Isocyanuric acid 2-200 mg/l
- Calcium hardness: 5-500 mg/l
- Bromine: 0.01-5.0 mg/l
- Alkalinity: 10-500 mg/l

Code	Standard Pack	Standard weight in kg	Standard volume in m ³
47190	1	1.0	0.049

3-in-1 photometer PC test kit



DESCRIPTION

- Chlorine range: 0.05-6.0 mg/l
- ph range: 6.5-8.4
- Cyanuric acid range: 0-80.0 mg/l

Code	Standard Pack	Standard weight in kg	Standard volume in m ³
54567	1	1.0	0.049

Test kits and photometers

Pool-Control-Direct



DESCRIPTION

Multiparameter photometer that enables a wide range of tests to be performed that cover all pool water readings. Intended for pool dealers.

	Code	Standard Pack	Standard weight in kg	Standard volume in m ³
Pool-Control-Direct	41922	1	1.9	0.023

Parameters tested (the reagents required can be ordered):

- | | |
|---------------------------------------|-------------------------------|
| Alkalinity: 10 – 500 mg/l | Total copper 0.03–5.0 mg/l |
| Aluminium: 0.02–0.5 mg/l | Free copper: 0.03–5.0 mg/l |
| Ammonia: 0.01–1.0 mg/l | Total hardness: 5–500 mg/l |
| Cyanuric acid: 2–200 mg/l | Phosphates: 0.03–4.0 mg/l |
| Biguanide: 2–100 mg/l | Iron: 0.01–1.0 mg/l |
| Bromine: 0.04–10.0 mg/l | Manganese: 0.001–0.03 mg/l |
| Calcium hardness: 5–500 mg/l | Nitrates: 0.02–20 mg/l |
| Chloride: 10–500 mg/l | Ozone: 0.01–2.0 mg/l |
| Free chlorine: 0.01–5.0 mg/l | Hydrogen peroxide: 1–100 mg/l |
| Total chlorine: 0.01–5.0 mg/l | pH: 6,8 – 8,4 |
| Free chlorine released: 0.01–10 mg/l | Salt level: 0–10.000 mg/l |
| Total chlorine released: 0.01–10 mg/l | Sulphates: 5–200 mg/l |
| Chlorine range: 1–250 mg/l | |

5-in-1 photometer PC test kit



DESCRIPTION

- Chlorine range: 0.05–6.0 mg/l
- ph range: 6.5–8.4
- Cyanuric acid range: 0–80.0 mg/l
- Alkalinity range: 5–200 mg/l
- Calcium hardness range: 50–500 mg/l

	Code	Standard Pack	Standard weight in kg	Standard volume in m ³
	54568	1	1.0	0.049

Photometer reagents



03009



	Format	Code	Standard Pack	Standard weight in kg	Standard volume in m ³
Phenol reagent tablets (pH)	250 units	03019	1	0.1	0.004
DPD-1 reagent tablets	250 units	03009	1	0.1	0.004
DPD-3 reagent tablets	250 units	03014	1	0.1	0.004
MPS-OUT reagent tablets	250 units	08679	1	0.1	0.004
(test for the amount of chlorine in the presence of Oximines)					
Isocyanuric acid reagent tablets	250 units	08345	1	0.1	0.004
Other reagents		Consult			

The transition to the new brand's visuals may take some time. It is possible to get products with visuals which have not yet been updated.

ctx[®] pro

We know, we take care, we live the water.

Our formula is unique: care, technology, knowledge.
Now with a new design, clearer and more functional.

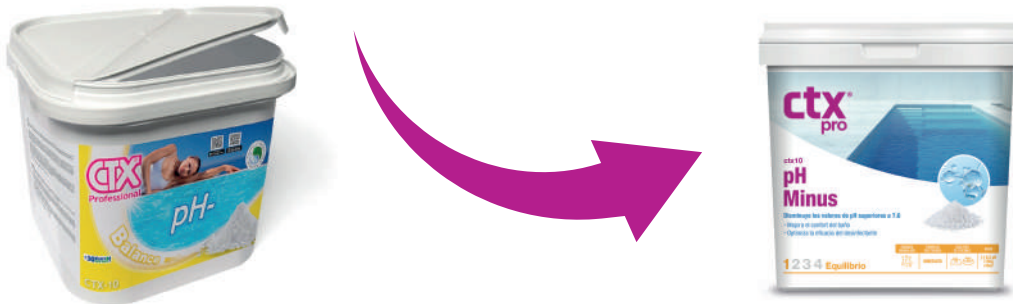

New design

Reference

Name of the product

Benefits and advantages of the product

Family & type of product



Format of the product

Usage guide

Everything you need for a healthy and perfect water in 4 steps:



Take care of the elements of your pool for a perfect efficacy.

Cleaning products



Take care of your pool during Winter.

Winter products



And if any type of problem arises, or you need extra care, a complete range of **CTX Solutions**.



ctx[®]
pro

The caring formula

ctxprofessional.com

Regulators



CTX 10 pH Minus

DESCRIPTION

Reduces pH values over 7.6.

- Enhances bathing comfort, preventing irritation of the eyes and mucous membranes and destruction of the skin's natural protective layer.
- Optimizes disinfectant efficacy.
- Prevents limescale.

GRANULATED	EFFICACY	ALL TYPES OF POOLS	DOSAGE		
	IMMEDIATE		150g / -0,2pH / 10m³		
	Format	Code	Standard Pack	Pallet weight Kg	Standard volume in m ³
	CTX 10 pH Minus	03105	18	648	-
	CTX 10 pH Minus	74650	4	720	-

CTX 15 pH Minus

DESCRIPTION

Reduces pH values over 7.6.

- Enhances bathing comfort, preventing irritation of the eyes and mucous membranes and destruction of the skin's natural protective layer.
- Optimizes disinfectant efficacy.
- Prevents limescale.
- Ideal for pump dosing.



LIQUID	EFFICACY	ALL TYPES OF POOLS	DOSAGE		
	IMMEDIATE		120ml / -0,2pH / 10m³		
	Format	Code	Standard Pack	Pallet weight Kg	Standard volume in m ³
	CTX 15 pH Minus	28399	1	600	-
	CTX 15 pH Minus	17181	1	400	-

Professional use only



LIQUID	EFFICACY	ALL TYPES OF POOLS	DOSAGE		
	IMMEDIATE		325ml / -0,2pH / 10m³		
	Format	Code	Standard Pack	Pallet weight Kg	Standard volume in m ³
	CTX 15 pH Minus	73669	1	600	-
	CTX 15 pH Minus	73670	1	400	-

The transition to the new brand's visuals may take some time. It is possible to get products with visuals which have not yet been updated.

Regulators



CTX 20 pH Plus



DESCRIPTION

Increases pH values under 7.2.

- Enhances bathing comfort, preventing irritation of the eyes and mucous membranes, and destruction of the skin's natural protective layer.
- Optimizes disinfectant efficacy.
- Prevents metal corrosion.

GRANULATED	EFFICACY	ALL TYPES OF POOLS	DOSAGE		
	IMMEDIATE		150g / -0,2pH / 10m³		
	Format	Code	Standard Pack	Pallet weight Kg	Standard volume in m ³
	CTX 20 pH Plus	16723	18	432	-
	CTX 20 pH Plus	74895	4	720	-



CTX 25 pH Plus



DESCRIPTION

Increases pH values under 7.2.

- Enhances bathing comfort, preventing irritation of the eyes and mucous membranes, and destruction of the skin's natural protective layer.
- Optimizes disinfectant efficacy.
- Prevents metal corrosion.
- Ideal for pump dosing.

LIQUID	EFFICACY	ALL TYPES OF POOLS	DOSAGE		
	IMMEDIATE		350ml / -0,2pH / 10m³		
	Format	Code	Standard Pack	Pallet weight LT	Standard volume in m ³
	CTX 25 pH Plus	17182	1	480	-

Regulators



CTX 21 Alka Plus

DESCRIPTION

Alkalinity has an important role as a regulatory effect of pH changes, correcting an unstable pH in the case of low alkalinity.

- Prevents pH fluctuations when alkalinity is between 125-150 ppm.
- Shores up water balance.
- Enhances bathing comfort.

GRANULATED	EFFICACY	ALL TYPES OF POOLS	DOSAGE			
	IMMEDIATE		180g / +10pH / 10m³			
	Format	Code	Standard Pack	Pallet weight Kg	Standard volume in m ³	
	CTX 21 Alka Plus	6 kg	03212	4	864	-



CTX 22 Calc +

DESCRIPTION

Increases water hardness at values below 175 ppm to prevent the corrosion of pool materials.

- Water hardness should be between 175 and 300 ppm.

GRANULATED	EFFICACY	ALL TYPES OF POOLS	DOSAGE			
	IMMEDIATE		150g / 10ppm / 10m³			
	Format	Code	Standard Pack	Pallet weight Kg	Standard volume in m ³	
	CTX 22 Calc +	5 kg	03214	4	864	-

Disinfectants





CTX 200/gr ClorShock

DESCRIPTION

Chlorine treatment for water recovery.

- Fast-dissolving.
- High water solubility makes it quick to obtain the necessary residual chlorine amount.
- Stable chlorine, lasts longer in the water.
- Does not modify pH.

GRANULATED	EFFICACY	ALL, SPECIALLY LINER AND POLIESTER	DOSAGE			
	IMMEDIATE		150g / 10m³			
	Format	Code	Standard Pack	Pallet weight Kg	Standard volume in m ³	
	CTX 200gr Clor Shock	1 kg	03135	18	432	-
	CTX 200gr Clor Shock	5 kg	03137	4	720	-
	CTX 200gr Clor Shock	25 kg	10905	1	450	-

CTX 250 ClorShock





These new codes only affect new formulas with low boric (European legislation)

DESCRIPTION

Chlorine treatment for water recovery.

- Fast-dissolving.
- The tablets have an effervescent effect ensuring swift rise in chlorine rate.
- Stable chlorine, lasts longer in the water.
- Does not modify pH.
- Recommended for use in tiled pools or in skimmer.

TABLET	EFFICACY	ALL TYPES OF POOLS	DOSAGE			
	IMMEDIATE		7 tablet / 10m³			
	Format	Code	Standard Pack	Pallet weight Kg	Standard volume in m ³	
	CTX 250 ClorShock	1 kg	75133	18	432	-
	CTX 250 ClorShock	5 kg	75134	4	720	-
	CTX 250 ClorShock	25 kg	75135	1	450	-

Disinfectants

CTX 12 Chlorine-bromine neutralizer



DESCRIPTION

Reduces chlorine or bromine residual excess.

- Quickly removes the disinfectant excess so bathers can enjoy the pool safely.

GRANULATED	EFFICACY	ALL TYPES OF POOLS	DOSAGE			
	IMMEDIATE		10g / -0.5ppm / 10m³			
	Format	Code	Standard Pack	Pallet weight Kg	Standard volume in m ³	
	CTX 12 Chlorine-bromine neutralizer	6 kg	03211	4	576	-

CTX 300 ClorLent



DESCRIPTION

Chlorine treatment for disinfecting the pool.

- Essential for ongoing pool treatment since the disinfectant is released as the water needs it.
- Stable chlorine, lasts longer in the water.
- Suitable for shock treatments and general maintenance.

POWDER	EFFICACY	ALL TYPES OF POOLS	DOSAGE			
	DAILY		10g / 10m³			
	Format	Code	Standard Pack	Pallet weight Kg	Standard volume in m ³	
	CTX 300 ClorLent	1 kg	03147	18	480	-
	CTX 300 ClorLent	5 kg	03149	4	720	-
	CTX 300 ClorLent	25 kg	19194	1	450	-

Disinfectants

CTX 300/gr ClorLent



DESCRIPTION

Chlorine treatment for disinfecting the pool.

- Essential for ongoing pool treatment since the disinfectant is released as the water needs it.
- Stable chlorine, lasts longer in the water.
- Suitable for shock treatments and general maintenance.

GRANULATED	EFFICACY	ALL TYPES OF POOLS	DOSAGE			
	DAILY		10g / 10m³			
	Format	Code	Standard Pack	Pallet weight Kg	Standard volume in m ³	
	CTX 300/gr ClorLent	1 kg	03154	18	480	-
	CTX 300/gr ClorLent	5 kg	03156	4	720	-
	CTX 300/gr ClorLent	25 kg	19195	1	450	-

CTX 370 ClorLent



These new codes only affect new formulas with low boric (European legislation)

DESCRIPTION

Chlorine treatment for disinfecting the pool.

- Slow-dissolving and continuous disinfection.
- Stable chlorine, lasts longer in the water.
- Dosing from the skimmer or in a floating dosing device is advised. Avoid direct contact with pools made with a polyester or vinyl liner or painted pools as it can cause discolorations.

TABLET	EFFICACY	ALL TYPES OF POOLS	DOSAGE			
	WEEKLY		1 tablet / 25m³			
	Format	Code	Standard Pack	Pallet weight Kg	Standard volume in m ³	
	CTX 370 ClorLent	1 kg	75136	18	432	-
	CTX 370 ClorLent	5 kg	75137	4	720	-
	CTX 370 ClorLent	25 kg	75138	1	450	-



Disinfectants



CTX 370SB ClorLent boric free

Chlorine treatment for disinfecting the pool.

- PureDrop technology:
 - 0% boric acid
 - 50% long-lasting than standard tablets
 - Leaves no residue in the water.
- Slow-dissolving and continuous disinfection.
- Stable chlorine, lasts longer in the water.
- Dosing in the skimmer or in a floating dosing device is advised. Avoid direct contact with pools made with a polyester or vinyl liner or painted pools as it can cause discolorations.



TABLET	EFFICACY	ALL TYPES OF POOLS	DOSAGE		
	7 / 10 DAYS		1 tablet / 30m³		
	Format	Code	Standard Pack	Pallet weight Kg	Standard volume in m ³
	CTX 370SB ClorLent	4 kg	69866	4	-



CTX 120 Hypocal

Calcium hypochlorite treatment for disinfecting the pool.

- Fast-dissolving.
- Unstabilized chlorine, no cyanuric acid is added to the water.
- Suitable for shock treatments and general maintenance.

GRANULATED	EFFICACY	ALL TYPES OF POOLS	DOSAGE		
	DAILY		10g / 10m³		
	Format	Code	Standard Pack	Pallet weight Kg	Standard volume in m ³
	CTX 120 Hypocal	5 kg	03130	4	360
	CTX 120 Hypocal	25 kg	03131	1	450

Disinfectants



CTX 400 ClorProtect

Keeps water disinfected for longer.

- Extends the disinfect action of chlorine since it prevents the rapid destruction caused by ultraviolet sunlight.
- Supplement for salt electrolysis or unstabilized chlorine treatments.
- For outdoor pools.
- Introduce the product in the skimmer or pump prefilter.

POWDER	EFFICACY	ALL TYPES OF POOLS	DOSAGE		
	IMMEDIATE		400g / 10m³		
	Format	Code	Standard Pack	Pallet weight Kg	Standard volume in m ³
CTX 400 ClorProtect	4.5 kg	73127	4	648	-



CTX 161 ClorLiquid

DESCRIPTION

Liquid chlorine for continuous water disinfection.

- Unstabilized chlorine, no cyanuric acid is added to the water.
- Suitable for shock treatments and general maintenance.

LIQUID	EFFICACY	ALL TYPES OF POOLS	DOSAGE		
	DAILY		500ml / 10m³		
	Format	Code	Standard Pack	Pallet weight Kg	Standard volume in m ³
CTX 161 ClorLiquid	20 l	47191	1	560	-

Disinfectants

CTX 390 Multiaction



DESCRIPTION

Multi-action, occasional-use chlorine treatment.

- Stable chlorine, lasts longer in the water.

GRANULATED	EFFICACY	ALL, SPECIAL TILE POOLS	DOSAGE		
	DAILY		15g / 10m³		
	Format	Code	Standard Pack	Pallet weight Kg	Standard volume in m ³
	CTX 390 Multiaction 5 kg	07897	4	480	-
	CTX 390 Multiaction 25 kg	19196	1	450	-

CTX 342 Multiaction 5



DESCRIPTION

Multi-action chlorine treatment for pool maintenance.

- Slow and continuous dissolution.
- Disinfection, antialgae, flocculant, coagulant, chlorine stabilizer.

TABLET	EFFICACY	ALL, SPECIALLY LINER AND POLIESTER	DOSAGE		
	WEEKLY		1 tablet / 25m³		
	Format	Code	Standard Pack	Pallet weight Kg	Standard volume in m ³
	CTX 342 Multiaction 5 1 kg	75140	18	432	-
	CTX 342 Multiaction 5 5 kg	75141	4	720	-
	CTX 342 Multiaction 5 25 kg	75142	1	450	-

These new codes only affect new formulas with low boric (European legislation)

Disinfectants





These new codes only affect new formulas with low boric (European legislation)

DESCRIPTION

Multi-action chlorine treatment for pool maintenance.

- Slow and continuous dissolution.
- Disinfection, antialgae, flocculant, coagulant, chlorine stabilizer.

TABLET	EFFICACY	ALL TYPES OF POOLS	DOSAGE		
	WEEKLY		1 tablet / 25m³		
	Format	Code	Standard Pack	Pallet weight Kg	Standard volume in m ³
CTX 393 Multiaction 5	1 kg	75143	18	432	-
CTX 393 Multiaction 5	5 kg	75144	4	720	-
CTX 393 Multiaction 5	25 kg	75145	1	450	-





These new codes only affect new formulas with low boric (European legislation)

CTX 379 Multiaction 5

DESCRIPTION

Multi-action chlorine treatment for pool maintenance.

- Slow and continuous dissolution.
- Disinfection, antialgae, flocculant, coagulant, chlorine stabilizer.

TABLET	EFFICACY	ALL, SPECIALLY CARTIGE FILTERS	DOSAGE		
	WEEKLY		1 tablet / 25m³		
	Format	Code	Standard Pack	Pallet weight Kg	Standard volume in m ³
CTX 379 Multiaction 5	5 kg	75146	4	720	-

Disinfectants



These new codes only affect new formulas with low boric (European legislation)

CTX 391 Multiaction 10

DESCRIPTION

Multi-action chlorine treatment for pool maintenance.

- Slow and continuous dissolution.
- Disinfection, antialgae, algicidal, flocculant, coagulant, chlorine stabilizer, antical, metal scavenger, corrosion protector, pH reducer.

TABLET	EFFICACY	ALL TYPES OF POOLS	DOSAGE		
250g	WEEKLY		1 tablet / 25m ³		
	Format	Code	Standard Pack	Pallet weight Kg	Standard volume in m ³
CTX 391 Multiaction 10	5 kg	75147	4	720	-



CTX 393SB Multiaction 10 Boric Free

DESCRIPTION

Multi-action chlorine treatment for pool maintenance.

- Slow and continuous dissolution.
- Disinfection, antialgae, algicidal, flocculant, coagulant, chlorine stabilizer, antical, metal scavenger, corrosion protector, pH reducer.

PURE DROP TECHNOLOGY

- Without boric acid
- Lasts 50% more
- No residue en the water

TABLET	EFFICACY	ALL TYPES OF POOLS	DOSAGE		
250g	7-10 days		1 tablet / 30m ³		
	Format	Code	Standard Pack	Pallet weight Kg	Standard volume in m ³
CTX 393SB Multi action 10	4 kg	69868	4	-	-

Disinfectants





These new codes only affect new formulas with low boric (European legislation)

CTX 230 Dosilong

DESCRIPTION

Floating dosing device for multi-action treatment for pool maintenance.

- Ensures ongoing and constant dosing, keeping the water disinfected and promoting an algacide and flocculant action.
- Specially designed for pools with a skimmer.
- Easy to use, no product handling.

FLOATING DISPENSER	EFFICACY	ALL TYPES OF POOLS		DOSAGE	
	3-4 WEEKS			1 / 50m³	
	Format	Code	Standard Pack	Pallet units	Standard volume in m ³
CTX 230 Dosilong	-	75149	6	96	-



CTX 130 Bromine



DESCRIPTION

Bromine treatment to disinfect the pool.

- Very slow-dissolving and continuous disinfection.
- Pleasant bathing, no odors.
- Does not irritate eyes.

TABLET	EFFICACY	ALL TYPES OF POOLS		DOSAGE	
	WEEKLY			1.0 - 3.0 ppm	
	Format	Code	Standard Pack	Pallet weight Kg	Standard volume in m ³
CTX 130 Bromine	5 kg	03183	4	400	-
CTX 130 Bromine	20 kg	27129	1	540	-

Disinfectants

CTX 17 Genbrom



DESCRIPTION

Inorganic compound that transform the active chlorine generated by a salt electrolysis treatment into bromine to disinfect the pool and keep it clean and hygienically pure.

- Bromine disinfectant efficacy is not reduced in contact with organic matter.
- More pleasant bathing without irritating the eyes or unpleasant odors.
- Ideal for covered pools treated with salt electrolysis.

GRANULATED	EFFICACY	ALL TYPES OF POOLS	DOSAGE			
	IMMEDIATE		500g / 10m³			
	Format	Code	Standard Pack	Pallet weight Kg	Standard volume in m ³	
	CTX 17 Genbrom	5 kg	23117	4	720	-

Algicides

CTX 575 Algae destroyer



DESCRIPTION

Concentrated product that successfully removes all type of algae, including hard-to-budge black algae.

- Fast-working, long-lasting.
- Non-foaming.

LIQUID	EFFICACY	ALL, EXCEPT LINER AND POLYESTER	DOSAGE			
	4 to 8h		200ml / 10m³			
CONCENTRATED	Format	Code	Standard Pack	Pallet units	Standard volume in m ³	
	CTX 575 Algae destroyer	1 l	71653	12	384	-
	CTX 575 Algae destroyer	3 l	71654	6	384	-

Algicides





CTX Phosfree

DESCRIPTION

Concentrated product to instantly remove algae-producing phosphates by inhibiting their growth.

- Prevents the appearance of algae.
- Compatible with all disinfectants.
- Enhances salt electrolysis output.
- With an easy-to-use dosing bottle.
- Phosphate concentration should be kept below 25ppb to prevent algae formation.



LIQUID	EFFICACY	ALL TYPES OF POOLS	DOSAGE		
 CONCENTRATED	WEEKLY		12ml / 10m³		
	Format	Code	Standard Pack	Pallet LT	Standard volume in m ³
CTX Phosfree		63108	12	480	-



CTX 500C Algastop Power

Concentrated product that prevents algae formation and growth.

- High bactericide, algaecide, and fungicide power.
- Fast-working, long-lasting.
- With an easy-to-use dosing bottle.

LIQUID	EFFICACY	ALL TYPES OF POOLS	DOSAGE		
 CONCENTRATED	WEEKLY		8ml / 10m³		
	Format	Code	Standard Pack	Pallet LT	Standard volume in m ³
CTX 500C Algastop Power	11	63120	12	576	-

Algicides

CTX 530C Algastop Ultra Power



DESCRIPTION

Concentrated product that prevents algae formation and growth, with a flocculant effect.

- High bactericide, algaecide, and fungicide power with a microfloculant power boosting its capacity to prevent the appearance of floating algae.
- Fast-working, long-lasting.
- Non-foaming, making it ideal for pools with counterflow systems or similar, water parks, etc.
- With an easy-to-use dosing bottle.

LIQUID	EFFICACY	ALL TYPES OF POOLS	DOSAGE		
 CONCENTRATED	WEEKLY		12ml / 10m³		
	Format	Code	Standard Pack	Pallet LT	Standard volume in m ³
	CTX 530C Algastop Ultra Power 1 l	63122	12	576	-

CTX 500 Algastop



DESCRIPTION

Prevents algae formation and growth.

- High bactericide, algaecide, and fungicide power.
- Fast-working, long-lasting.

LIQUID	EFFICACY	ALL TYPES OF POOLS	DOSAGE		
	WEEKLY		50ml / 10m³		
	Format	Code	Standard Pack	Pallet LT	Standard volume in m ³
	CTX 500 Algastop 5 l	03194	4	640	-
	CTX 500 Algastop 25 l	03195	1	600	-

Algicides





CTX 60 AlgaStop Cristal

DESCRIPTION

Prevents algae formation and growth.

- Clarifies the water, increasing transparency.
- Keeps water blue.

LIQUID	EFFICACY	ALL TYPES OF POOLS		DOSAGE	
	WEEKLY			50ml / 10m³	
	Format	Code	Standard Pack	Pallet LT	Standard volume in m ³
CTX 60 AlgaStop Cristal	5 l	03190	4	640	-





CTX 530 Algastop Ultra

DESCRIPTION

Prevents algae formation and growth.

- High bactericide, algaecide, and fungicide power.
- Fast-working, long-lasting.
- Non-foaming, making it ideal for pools with counterflow systems or similar, water parks, etc.

LIQUID	EFFICACY	ALL TYPES OF POOLS		DOSAGE	
	WEEKLY			25ml / 10m³	
	Format	Code	Standard Pack	Pallet LT	Standard volume in m ³
CTX 500C Algastop Power	5 l	03204	4	640	-
CTX 500C Algastop Power	25 l	03205	1	600	-

Flocculants

CTX 39 Pool Gel



DESCRIPTION

Single-dose flocculant gel for crystal-clear water.

- Increases filter and disinfectant efficacy.
- Easy to use, no product handling.

MONODOSE	EFFICACY	ALL TYPES OF POOLS	DOSAGE		
	15 DAYS		1 MONODOSE / up to 60m³		
	Format	Code	Standard Pack	Pallet weight Kg	Standard volume in m ³
	CTX 39 Pool gel Pack 36 un.	61363	2	6912	-
	CTX 39 Pool gel (un)	61363UN		-	-

CTX Care Pods



DESCRIPTION

Multifunctional water-soluble film, single-dose.

- Stops water turning cloudy.
- Prevents algae growth.
- Prevents foam generation.
- Immediate effect.
- Efficacy unaltered by possible temperature rises or pH variations.

MONODOSE	EFFICACY	ALL TYPES OF POOLS	DOSAGE		
	WEEKLY		1 MONODOSE / up to 50m³		
	Format	Code	Standard Pack	Pallet weight Kg	Standard volume in m ³
	CTX Care Pods 35 g	73119	-	-	-
	CTX Care Pods (un)	73119UN	-	-	-

Flocculants

CTX Natural Flocculant



DESCRIPTION

Naturally sourced concentrate that keeps water crystal-clear.

- Removes remains of body creams and oils, foam and excess metal.
- Suitable for salt electrolysis, boosting output.
- Compatible with all disinfectants.
- Easy-clean filter.
- With an easy-to-use dosing bottle.

LIQUID	EFFICACY	ALL TYPES OF POOLS	DOSAGE		
	WEEKLY		8ml / 10m ³		
	Format	Code	Standard Pack	Pallet weight Kg	Standard volume in m ³
	CTX Natural Flocculant	63107	12	480	-



CTX 43 Flocculant Deluxe

DESCRIPTION

Removes the particles from the water that turn it cloudy.

- Clean, crystal-clear water.
- Fast flocculation, continuous clarification.
- Improves disinfectant output.

CARTIDGE	EFFICACY	ALL TYPES OF POOLS	DOSAGE		
	10 DAYS		1 CARTRIDGE / up to 50m ³		
	Format	Code	Standard Pack	Pallet weight Kg	Standard volume in m ³
	CTX 43 Flocculant Deluxe	46664	14	35	-

Flocculants





CTX 42 Flocculant

DESCRIPTION

Removes the particles from the water that turn it cloudy.

- Improves water transparency.
- Coagulant action.
- Place tablet in skimmer.

TABLET	EFFICACY	ALL TYPES OF POOLS	DOSAGE		
	10 DAYS		1 TABLET UP TO 50m³		
	Format	Code	Standard Pack	Pallet weight Kg	Standard volume in m ³
	CTX 42 Flocculant 5 kg	03119	4	480	-
	CTX 42 Flocculant 25 kg	03120	1	450	-





CTX 37 Xtreme Floc

DESCRIPTION

Shock treatment to completely remove particles from the water.

- For crystal-clear water.
- Slow and controlled dissolution.
- Coagulant and flocculant action.
- Improves filter and disinfectant output.
- Removes metal ions like iron and manganese and eliminates organic matter

TABLET	EFFICACY	ALL TYPES OF POOLS	DOSAGE		
	8h		1 TABLET / 20m³		
	Format	Code	Standard Pack	Pallet weight Kg	Standard volume in m ³
	CTX 37 Xtreme Floc 20 un.	60044	8	144	-



Flocculants





CTX 41 Flocculant



DESCRIPTION

Shock treatment that removes the particles from the water that turn it cloudy.

- Clarifies the water, restoring transparency.
- Fast-acting.
- Improves disinfectant output.

LIQUID	EFFICACY	ALL TYPES OF POOLS	DOSAGE		
	8h		100ml / 10m³		
	Format	Code	Standard Pack	Pallet weight Kg	Standard volume in m ³
CTX 41 Flocculant	5 l	03117	4	640	-
CTX 41 Flocculant	25 l	03118	1	600	-

Cleaners





CTX 51 WallCleaner Plus



DESCRIPTION

Cleans the pool basin.

- Detergent cleaner specially formulated to remove the limescale, organic residues, and mineral sediments that form over time and attach to pool surfaces.

LIQUID	EFFICACY	ALL TYPES OF POOLS	DOSAGE		
	30min		2l / 10m³		
	Format	Code	Standard Pack	Pallet LT	Standard volume in m ³
CTX 51 WallCleaner Plus	5 l	03124	4	640	-
CTX 51 WallCleaner Plus	25 l	03125	1	600	-

Cleaners





CTX 53 WallCleaner Liner

DESCRIPTION

Cleans the pool basin.

- Detergent cleaner specially formulated to remove the limescale, organic residues, and mineral sediments that form over time and attach to pool surfaces.
- Special for liner or polyester pools.

LIQUID	EFFICACY	ALL TYPES OF POOLS	DOSAGE			
	30min		2l / 10m³			
	Format	Code	Standard Pack	Pallet weight Kg	Standard volume in m ³	
	CTX 53 WallCleaner	5 l	07882	4	640	-





CTX 56 Netoline

DESCRIPTION

Cleans the waterline.

- Gel detergent specially formulated to remove oil, dirt, and limescale from pool edges, walls and surrounds as required.
- Due to gel consistency it sticks to the walls, preventing splash-back.

GEL	EFFICACY	ALL TYPES OF POOLS	DOSAGE			
	IMMEDIATE		SPONGE			
	Format	Code	Standard Pack	Pallet weight Kg	Standard volume in m ³	
	CTX 56 Netoline	5 l	38811	4	640	-

Cleaners





CTX 75 Waterline Cleaner

DESCRIPTION

Cleans the waterline.

- Gel detergent specially formulated to remove oil, dirt, and limescale from pool edges, walls and surrounds as required.

LIQUID	EFFICACY	ALL TYPES OF POOLS	DOSAGE		
	IMMEDIATE		SPONGE		
	Format	Code	Standard Pack	Pallet LT	Standard volume in m ³
CTX 75 Waterline Cleaner	5 l	03222	4	640	-
CTX 75 Waterline Cleaner	25 l	03223	1	600	-





CTX 70 Surfosan

DESCRIPTION

Sanitizer multi-surface.

- Does not alter water parameters.
- Respectful with the surface.

LIQUID	EFFICACY	ALL TYPES OF POOLS	DOSAGE		
	IMMEDIATE		SPONGE		
	Format	Code	Standard Pack	Pallet weight Kg	Standard volume in m ³
CTX 70 Surfosan	1 l	73941	9	-	-
CTX 70 Surfosan	5 l	05453	4	640	-
CTX 70 Surfosan	25 l	05454	1	600	-

Cleaners





CTX 600 Descaler

DESCRIPTION

Prevents limescale.

- Removes and prevents limescale. Helps stop filters from clogging up and corrosion of metal parts in the recirculation and filter system.

LIQUID	EFFICACY	ALL TYPES OF POOLS	DOSAGE		
	IMMEDIATE		SPONGE		
	Format	Code	Standard Pack	Pallet LT	Standard volume in m ³
CTX 600 Descaler	5 l	03229	4	640	-





CTX 700 Descaler Super

DESCRIPTION

Prevents limescale and iron stains.

- Prevents limescale formation on walls, ladders, bottoms and filters as a result of hard water.
- Keeps the water recirculation, pump, and heat-exchange circuits clean.
- Prevents stains forming on the basin as a result of iron in the water.
- Non-foaming.

LIQUID	EFFICACY	ALL TYPES OF POOLS	DOSAGE		
	IMMEDIATE		SPONGE		
	Format	Code	Standard Pack	Pallet LT	Standard volume in m ³
CTX 700 Descaler Super	5 l	03231	4	640	-

Cleaners





CTX 800 Inhibical



DESCRIPTION

Prevents the limescale produced by using liquid chlorine that clogs up dosing systems (dosing pumps, tubes, etc.).

- Prevents the corrosion of metal pool parts.

LIQUID	EFFICACY	ALL TYPES OF POOLS		DOSAGE	
	DAILY			500ml / 50 cl liquid	
	Format	Code	Standard Pack	Pallet LT	Standard volume in m ³
CTX 800 Inhibical	5 l	20265	4	640	-





CTX 35 Descaler electrolyte cells



DESCRIPTION

Removes limescale that forms and sticks to electrodes and reduces electrochlorinator output and performance.

- Extends electrochlorinator life.

LIQUID	EFFICACY	ALL TYPES OF POOLS		DOSAGE	
	8h			100ml / 10m³	
	Format	Code	Standard Pack	Pallet LT	Standard volume in m ³
CTX 35 Descaler	5 l	31127	4	640	-

Cleaners



CTX 57 Netafilter

DESCRIPTION

Cleans the inside of sand filters.

- Removes limescale caused by salts in the water and dirt deposited inside sand filters.
- Non-foaming.
- For stainless steel or sand/polyester, silex or ecoglass.

LIQUID	EFFICACY	POOLS WITH SAND FILTER	DOSAGE			
	4h / 8h		2 l / 10kg sand			
	Format	Code	Standard Pack	Pallet LT	Standard volume in m ³	
	CTX 57 Netafilter	5 l	08671	4	640	-

Maintenance Kit



CTX 205 Baby Pool

DESCRIPTION

Complete kit for small inflatable or removable pools.

- Keeps the water clean without having to empty the pool
- It contains 0.5 l of dichlor granules and 0.5 l of concentrated algicide.

KIT	TYPES OF POOLS	DISINFECTION	EFFICACY	ALGICIDE	EFFICACY
with dispenser	Mini Pools		DAILY		WEEKLY
	Format	Code	Standard Pack	Pallet weight Kg	Standard volume in m ³
	CTX 205 Baby Pool	1 uni.	03176	14	-

Winterising products





CTX 550 WinterStar

DESCRIPTION

Complete treatment in winter.

- Prevents algae and bacteria proliferation.
- Prevents the formation of lime.
- Non-foaming.

LIQUID	EFFICACY	ALL TYPES OF POOLS	DOSAGE		
	3 MONTHS		500ml / 10m³		
	Format	Code	Standard Pack	Pallet weight Kg	Standard volume in m ³
CTX 550 WinterStar	5 l	03226	4	640	-
CTX 550 WinterStar	25 l	20906	1	600	-





CTX 551 WinterStar Liner

DESCRIPTION

Complete treatment in winter.

- Prevents algae and bacteria proliferation.
- Non-foaming.

LIQUID	EFFICACY	ALL TYPES OF POOLS	DOSAGE		
	3 MONTHS		830ml / 10m³		
	Format	Code	Standard Pack	Pallet weight Kg	Standard volume in m ³
CTX 551 WinterStar Liner	5 l	17228	4	640	-

Winterising products

CTX 551C WinterStar Power



DESCRIPTION

Concentrated product for complete treatment in winter.

- Prevents algae and bacteria proliferation.
- Non-foaming.
- With an easy-to-use dosing bottle.

LIQUID	EFFICACY	ALL TYPES OF POOLS	DOSAGE		
	3 MONTHS		200ml / 10m³		
	Format	Code	Standard Pack	Pallet LT	Standard volume in m ³
CTX 551C WinterStar Power	1 l	63163	12	576	-

CTX 235 Sleepy



DESCRIPTION

Floating dosing device for complete treatment in winter.

- Prevents algae and bacteria proliferation.
- Easy to use, no product handling.

FLOATING DISPENSER	EFFICACY	ALL TYPES OF POOLS	DOSAGE		
	3 MONTHS		1ml / 50m³		
	Format	Code	Standard Pack	Pallet units	Standard volume in m ³
CTX 235 Sleepy		75150	6	96	-

These new codes only affect new formulas with low boric (European legislation)





WATER TREATMENT EQUIPMENT



266 RESIDENTIAL POOLS WATER TREATMENT SOLUTIONS

267 SALT WATER ELECTROLYSIS - RESIDENTIAL POOLS

- 268 Elite Connect
- 269 Smart Next
- 270 Energy Sel
- 270 Sel Clear
- 270 Bering Sel
- 271 E-Next
- 272 Earthing anode
- 272 Electrodes

274 AUTOMATIC UV DISINFECTION - RESIDENTIAL POOLS

- 274 Neolysis 2
- 275 Heliox UV
- 276 Lyriox UV-C
- 276 UV-C TL

279 PH & CHLORINE AUTOMATIC REGULATIONS - RESIDENTIAL POOLS

- 279 Control Connect
- 280 Relay Box
- 280 Dual pH-EV Basic Control Plus
- 281 Control Basic Plus
- 281 Redox Basic EV Plus
- 282 Control Basic Next
- 282 Redox Basic EV Next

283 DOSING PUMPS

- 283 Optima
- 284 Optima Next
- 285 Optima Plus

287 DOSING EQUIPMENT

290 WATER METERS & CONTROL DEVICES









- Disinfection management and pH management represent 20% of pool water treatment but 80% of daily in-store enquiries.
- Correctly managing disinfection and pH is then key for a perfect pool experience. AstralPool® offers 4 product families to relieve the pool owners from constraints.

HOW TO CHOSE THE MOST ADAPTED WATER TREATMENT SOLUTION?

Our water treatment product portfolio allows pool owners to adapt their equipment to their needs, from lowering maintenance constraints to increasing bathing comfort, connectivity or environmentally friendly solutions. The chart below will help you chose the best option for your pool.

For an optimal disinfection against pathogens (bacteria, viruses, fungi...), you may combine UV treatment with chlorinated treatment. It delivers a larger efficacy spectrum ensuring pool's water is disintected AND disinfected.









				
	Dosing	UV	Salt Water Electrolysis	Neolysis 2
Type of disinfection	Liquid chlorine	UV treatment	Salt water chlorination	Hybrid UV treatment + Salt water chlorination
pH regulation*	✓	✓	✓	✓
Disinfection regulation**	✓	✓	✓	✓
Automated dosing / disinfecting	✓	✓	✓	✓
IoT connectivity : remote control with an app	 Fluidra Connect compatible	-	 Fluidra Connect compatible 	 Fluidra Connect compatible 
Reduced maintenance constraints	✓	✓✓	✓✓✓	✓✓✓
Reduced use/handling of chemicals	✓	✓✓	✓✓✓	✓✓✓
Gentle and eco-friendly treatment	✓	✓✓	✓✓	✓✓✓
Investment	At installation	€ - €€€	€€ - €€€	€€ - €€€
	Seasonal cost	€€€	€€	€

* When ✓ : depending on model.

** Could be either ORP or PPM free chlorine depending on model.

MODEL COMPARISON

	 Elite Connect				 Smart Next					 Energy Sel			 Bering Sel
Product name	Elite Connect				Smart Next					Energy Sel			Bering Sel
Chlorine output (g/h)	12	24	32	42	7	12	21	30	40	9	13	19	8
Pool volume Based on 8 h/day of chlorination for a pool water = 25°C (if pool water > 25°C : -15% max volume)	50	100	150	200	30	50	90	140	180	40	55	85	35
Salinity (g/L)	Standard Mini: 5 - Ideal: 6 Low Salt Mini: 1 - Ideal: 2				Mini: 5 - Ideal: 6					Mini: 3,5 - Ideal: 4			Mini: 3,2 - Ideal: 4
Output control	0-100%				0-100% (10 levels)					0-100%			0-100% (4 levels)
User interface	2,8" Oled colour touchscreen				Back-lit touchscreen					2 digits LCD screen			LED
Minimum flow rate (m³/h)	2	4	6	8	2	3	5	6	8	2	3	4	3
Electric power (W)	83	165	205	205	46	92	92	184	207	70			100
Protection rating	IP65				IP65					IP45			IP24
Type of cell	Horizontal or vertical				Horizontal or vertical					Horizontal or vertical			Horizontal or vertical
Cell service life	12,000 h				10,000 h					8,000 h			8,000 h
Polarity reversal	✓ (2-3-4 h)				✓ (2-3-4-7 h)					✓ (0 to 99 h)			✓
Cover mode	✓				✓					✓			-
Boost mode	-				✓					-			-
Lack of water:													
Gas sensor	✓				✓					-			-
Flow Switch	✓				✓ (Optional)					✓ (Optional)			-
Salt fail-safe mode (High - Low)	✓				✓					-			-
Running time counter	✓				✓					-			-
Temperature display	✓				✓					-			-
Salinity display	✓				✓					-			-
Timer scheduling	✓				-					-			-
Connectivity / App control:													
NN Thing (Connect & Go automation)										-			-
PoolStation app					-					-			-
External output control	✓				✓					-			-
pH control	✓ (Scalable)				✓ (Optional)					-			-
Sensor holder included	✓				✓					-			-
pH pump included	✓				✓					-			-
ORP control	✓ (Scalable)				✓ (Optional)					-			-
ppm control	✓ (Scalable)				-					-			-
Low Salt version	✓				-					-			-
Timer	✓				-					-			-
Inputs - Outputs	4 (digital) - 4 (relays)				-					-			-
Warranty	3 years				2 years					2 years			2 years

Elite Connect

+ A fully automated pH and chlorine control unit with all of the added advantages of salt water chlorination.

DESCRIPTION

- Connected product with built-in Ethernet port and PoolStation app (available on iOS & aOS).
- NN Thing: Smart control within Fluidra Connect pool automation and NN app (available on iOS & aOS).
- Scalable control functions with S-Driver® plug-in modules (pH, Rx and Cl ppm).
- NEW for 2022 : 2.8" OLED colour touch screen with enhanced display
- NEW for 2022 : integrated timer scheduling for all controlled pool features.
- 4 digital inputs and 4 digital outputs (relays) to control filter pump, heater, lighting, etc.
- Equipped with a gas sensor, a flow switch and a compact sensor holder as standard.
- Equipped with high quality electrodes, with a service life of up to 12,000 hours under normal conditions.
- Output control from 0 to 100%.
- pH dosing pump included with pH option.
- Low-salt version (1-2 g/l).
- Optional VSP S-Driver® that can control 3-speed variable speed pumps and backwash piston valves.
- Optional Relay Box to ease the installation between Elite Connect and the controlled pool equipment. See page 280.



Fluidra Connect compatible

	Code	Standard Pack	Standard weight in kg	Standard volume in m³
Elite Connect				
Up to 50 m³ 12 g/h	70012	1	6.30	0.047
Up to 100 m³ 24 g/h	70013	1	8.20	0.047
Up to 150 m³ 32 g/h	70014	1	9.10	0.047
Up to 200 m³ 42 g/h	70016	1	9.50	0.047
Elite Connect pH				
Up to 50 m³ pH 12 g/h	70019	1	7.70	0.047
Up to 100 m³ pH 24 g/h	70021	1	9.50	0.047
Up to 150 m³ pH 32 g/h	70023	1	10.60	0.047
Up to 200 m³ pH 42 g/h	70025	1	10.90	0.047
Elite Connect pH/Rx				
Up to 50 m³ 12 g/h	70031	1	8.15	0.047
Up to 100 m³ 24 g/h	70032	1	9.95	0.047
Up to 150 m³ 32 g/h	70033	1	11.05	0.047
Up to 200 m³ 42 g/h	70035	1	11.35	0.047
Elite Connect pH/ppm				
Up to 50 m³ 12 g/h	70361	1	13.80	0.080
Up to 100 m³ 24 g/h	70363	1	14.90	0.080
Up to 150 m³ 32 g/h	70365	1	16.60	0.080
Up to 200 m³ 42 g/h	70369	1	16.90	0.080
Elite Connect LS				
LS. Up to 50 m³ 12 g/h	70037	1	6.30	0.047
LS. Up to 100 m³ 24 g/h	70039	1	8.20	0.047
LS pH. Up to 50 m³ 12 g/h	70040	1	7.70	0.047
LS pH. Up to 100 m³ 24 g/h	70042	1	9.50	0.047
LS pH/Rx. Up to 50 m³ 12 g/h	70047	1	7.80	0.047
LS pH/Rx. Up to 100 m³ 24 g/h	70048	1	8.90	0.047
LS pH/ppm. Up to 50 m³ 12 g/h	70371	1	14.90	0.080
LS pH/ppm. Up to 100 m³ 24 g/h	70372	1	16.60	0.080
Option				
Relay Box	72454	1	9,5	-
S-Driver® modules				
SD-pH	70049	1	0.80	0.06
SD-Pump (pH)	70054	1	0.80	0.06
SD-ORP	70051	1	0.80	0.06
SD-PPM	70052	1	6.00	0.051
SD-VSP	73471	1	0.80	0.002



Possibility of upgrading the unit with S-Driver® modules

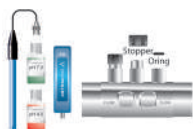

70049



70054



70051



70052



73471

Smart Next

+ A salt water chlorinator with optional pH and ORP automated control.



Fluidra Connect compatible

DESCRIPTION

- NN Thing: Smart control within Fluidra Connect pool automation and NN app (available on iOS & aOS).
- NEW for 2022 : 24h Boost mode.
- NEW For 2022 : "Bio pool" mode with specific pH & ORP setpoint thresholds.
- Smart Next is available as a Salt water chlorinator, or with regulations: pH only or pH and Redox for chlorination control.
- Equipped with a gas sensor (optional flow switch) and compact sensor holder (pH and pH/Rx options) as standard.
- Monitors temperature and salinity.
- Equipped with high quality electrodes, with a service life of up to 10 000 hours under normal conditions.
- Output control from 0 to 100%.
- pH dosing pump included with pH and pH/Rx options.

	Code	Standard Pack	Standard weight in kg	Standard volume in m ³
Smart Next				
Up to 30 m ³ 7 g/h	70058	1	4.80	0.047
Up to 50 m ³ 12 g/h	70060	1	6.30	0.047
Up to 90 m ³ 21 g/h	70062	1	8.20	0.047
Up to 140 m ³ 30 g/h	70063	1	9.10	0.047
Up to 180 m ³ 40 g/h	70064	1	9.50	0.047
Smart Next pH				
Up to 30 m ³ 7 g/h	70083	1	6.20	0.047
Up to 50 m ³ 12 g/h	70084	1	7.70	0.047
Up to 90 m ³ 21 g/h	70085	1	9.50	0.047
Up to 140 m ³ 30 g/h	70086	1	10.60	0.047
Up to 180 m ³ 40 g/h	70093	1	10.90	0.047
Smart Next pH/Rx				
Up to 30 m ³ 7 g/h	71692	1	6.65	0.047
Up to 50 m ³ 12 g/h	71693	1	8.15	0.047
Up to 90 m ³ 21 g/h	71694	1	9.95	0.047
Up to 140 m ³ 30 g/h	71695	1	11.05	0.047
Up to 180 m ³ 40 g/h	71696	1	11.35	0.047
Option:				
Flow switch kit	71124	1	0.17	0.002



pH accessories
(provided with pH & pH/Rx models)



ORP accessories
(provided with pH/Rx models)





Energy Sel

DESCRIPTION

Self-cleaning salt water chlorinator thanks to polarity reversal. Flat screen design. Easy to install and use. On / off push button located in the lower part to avoid involuntary disconnections. It is recommended for pools up to 85 m³. Relay for automatic cover. Optional flow switch (code 300227 includes D.63 collar; code 300228 includes D.50 collar).

		Code	Standard Pack	Standard weight in kg	Standard volume in m ³
Chlorine output:					
Up to 40 m ³	9 g/h	71650	1	3.50	0.025
Up to 55 m ³	13 g/h	71651	1	3.65	0.025
Up to 85 m ³	19 g/h	71652	1	3.70	0.025

Sel Clear



DESCRIPTION

Self-cleaning salt water chlorinator thanks to polarity reversal. Easy to install and use. It is recommended for pools up to 85 m³. Relay for automatic cover. Optional flow switch (code 300227 includes D.63 collar; code 300228 includes D.50 collar).

		Code	Standard Pack	Standard weight in kg	Standard volume in m ³
Chlorine output:					
Up to 40 m ³	9 g/h	54041	1	3.50	0.025
Up to 55 m ³	13 g/h	54042	1	3.65	0.025
Up to 85 m ³	19 g/h	54043	1	3.70	0.025

Bering Sel



DESCRIPTION

Self-cleaning salt water chlorinator thanks to polarity reversal. For pools up to 35 m³. Compact design. Manual output adjustment (from 0 to 100%). 3 indicators: solid green = running, solid red = in standby mode, flashing red = failure (lack of water, lack of salt).

		Code	Standard Pack	Standard weight in kg	Standard volume in m ³
Chlorine output:					
Up to 35 m ³	8 g/h	64315	1	6.0	-

Salt test kit



DESCRIPTION

Salt test strips for checking salt levels. Salt levels must be checked on a regular basis as the water is renewed.

		Code	Standard Pack	Standard weight in kg	Standard volume in m ³
Salt test strips bottle		07937	1	0.8	0.001

E-Next



DESCRIPTION

E-Next salt water chlorinator is able to treat pools up to 180 m³. It automatically disinfects and lowers the chlorine production if pool is equipped with an automatic pool cover (dedicated dry contact).

The polarity reversal will help cleaning the electrodes, and its salt alarm will warn the user in case of low salt concentration to avoid damaging the cell and the pool to turn green.

NEW for 2022 : Also exists in pH version that includes pH regulation & dosing for a complete water treatment.

		Code	Standard Pack	Standard weight in kg	Standard volume in m ³
Chlorine output:					
E-Next					
Up to 30 m ³	7 g/h	74081	1	4.80	0.047
Up to 50 m ³	12 g/h	74082	1	6.30	0.047
Up to 90 m ³	21 g/h	74083	1	8.20	0.047
Up to 140 m ³	30 g/h	74084	1	9.10	0.047
Up to 180 m ³	40 g/h	74085	1	9.50	0.047
E-Next pH					
Up to 30 m ³	7 g/h	74944	1	6.20	0.047
Up to 50 m ³	12 g/h	74945	1	7.70	0.047
Up to 90 m ³	21 g/h	74946	1	9.50	0.047
Up to 140 m ³	30 g/h	74947	1	10.60	0.047
Up to 180 m ³	40 g/h	74948	1	10.90	0.047



pH accessories (provided with pH version)

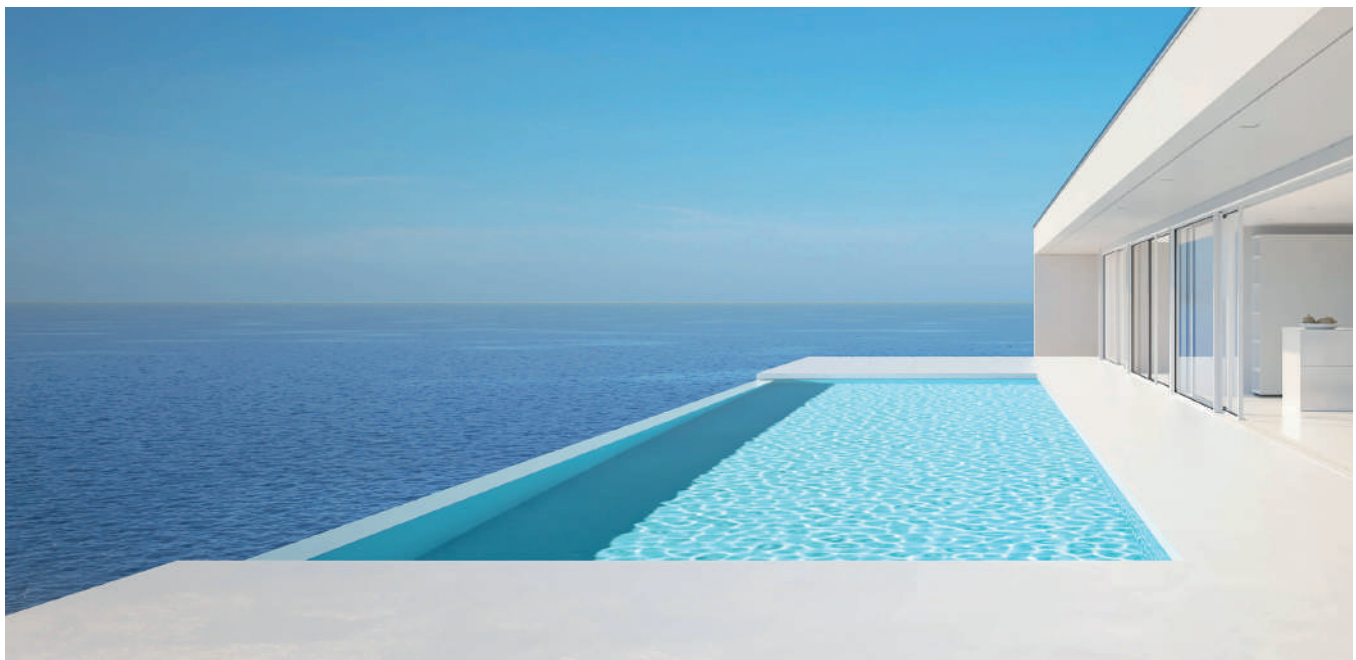

Earthing anode



DESCRIPTION

Easy-to-install stainless steel earthing anode to remove roaming currents that might be present with salt water. Provided with saddle clamp kit.

	Code	Standard Pack	Standard weight in kg	Standard volume in m ³
For Ø 50 mm	25894	1	0.6	0.001
For Ø 63 mm	25895	1	0.6	0.001

Elite Connect electrodes



	Code	Standard Pack	Standard weight in kg	Standard volume in m ³
Elite Connect 12 electrode (Codes 70012 / 70019 / 70031 / 70361)	60588	1	-	-
Elite Connect 24 electrode (Codes 70013 / 70021 / 70032 / 70363)	60589	1	-	-
Elite Connect 32 electrode (Codes 70014 / 70023 / 70033 / 70365)	60594	1	-	-
Elite Connect 42 electrode (Codes 70016 / 70025 / 70035 / 70369)	70316	1	-	-
Elite Connect 12 LS electrode (Codes 70037 / 70040 / 70047 / 70371)	70317	1	-	-
Elite Connect 24 LS electrode (Codes 70039 / 70042 / 70048 / 70372)	70318	1	-	-

Smart Next electrodes



	Code	Standard Pack	Standard weight in kg	Standard volume in m ³
Smart Next 7 electrode (Codes 70058 / 70083 / 71692 / 74081)	60595	1	-	-
Smart Next 12 electrode (Codes 70060 / 70084 / 71693 / 74082)	60596	1	-	-
Smart Next 21 electrode (Codes 70062 / 70085 / 71694 / 74083)	70312	1	-	-
Smart Next 30 electrode (Codes 70063 / 70086 / 71695 / 74084)	70314	1	-	-
Smart Next 40 electrode (Codes 70064 / 70093 / 71696 / 74085)	70315	1	-	-

Energy Sel / Sel Clear electrodes









	Code	Standard Pack	Standard weight in kg	Standard volume in m ³
Electrode 30: up to 40 m ³	54051	1	0.35	0.0055
Electrode 55: up to 55 m ³	54052	1	0.44	0.0055
Electrode 95: up to 85 m ³	54053	1	0.50	0.0055

Bering Sel electrode



	Code	Standard Pack	Standard weight in kg	Standard volume in m ³
Electrode: up to 35 m ³	72889	1	0.5	0.0070

MODEL COMPARISON

																			
Product name	Neolysis 2			Heliox UV LP SS				Heliox UV LP PE				Lyriox UV-C							
Type	Hybrid UV + electrolysis			UV treatment				UV treatment				UV treatment							
Power range (rated UV Watt)	48	56	56	48	56	90	150	48	56	75	90	15	25	30	50	55	75	110	
Chlorine output (g/h electrolysis)	12	24	32	-				-				-							
Salinity (g/L)	Standard	Mini: 5 - Ideal: 6	Low Salt	-				-				-							
Max pool volume (m ³). Based on 8 h/day filtration for a pool water = 25°C (if temp >25°C : -15% max volume)	50	100	150	50	60	90	140	50	60	75	90	15	25	30	50	55	75	110	
Flow rate (m ³ /h for 30 mJ/cm ² UV efficiency)	10	14	18	10	14	25	30	10	14	20	25	2	2	4	5	8	10	15	
UV reactor																			
Body material	Polyethylene (PE)			AISI 316L Stainless Steel				Polyethylene (PE)				PVC							
Compatible with salt water	✓			-				✓				✓							
Max pressure (bar)	3,0			3,0				3,0				2,5							
UV lamp service life (hours)	13.000			13.000				13.000				9.000							
Electrolysis electrode service life (hours)	12.000			-				-				-							
Power pack / Ballast casing																			
User interface	2,8" Oled touchscreen			LCD screen(s)				LCD screen(s)				-							
UV lamp running time counter	✓			✓				✓				Reminder label							
Ballast type	Integrated			Integrated				Integrated				Integrated							
pH control	✓ (scalable)			✓ (depends on model)				✓ (depends on model)				-							
pH dosing pump included	✓			✓				✓				-							
Sensor holder included	✓			✓				✓				-							
ORP control	✓ (scalable)			✓ (depends on model)				✓ (depends on model)				-							
Timer schedules	✓			-				-				-							
Polarity reversal	✓ (2-3-4 h)			-				-				-							
Cover mode	✓			-				-				-							
Flow switch	✓			✓				✓				-							
External output control	✓			-				-				-							
Iputs - Outputs	4 (digital) - 4 (relays)			-				-				-							
Connectivity / App control																			
NN Thing (Connect & Go automation)				-				-				-							
Poolstation app				-				-				-							
Warranty	3 years			2 years				2 years				2 years							

- + Neolysis is the most advanced water treatment from AstralPool. It is a patented hybrid sanitation system combining UV treatment with salt water electrolysis to deliver an unrivalled efficiency against pathogens.
- + NEW for 2022 : Neolysis 2 range using a new connected power pack with 2.8" Oled touchscreen and pool equipment control capability.



Fluidra Connect compatible



Possibility of upgrading the unit with S-Driver® modules

Neolysis 2



DESCRIPTION

- Water suitable for watering.
- Hybrid disinfection based on UV and electrolysis.
- Unbeatable water quality.
- Sustainable and healthier treatment.
- Connected product (Poolstation app) with pool equipment control capability (4 inputs & 4 outputs).
- UV LP high quality lamps (13,000 h).
- High quality electrolysis electrodes (12,000 h).
- Patented process.
- Optional Relay Box to ease the installation between Neolysis 2 and the controlled pool equipment. See page 280.

	Code	Standard Pack	Standard weight in kg	Standard volume in m ³
Neolysis 2 LS (low salt 1 g/L)				
AP NEO-S2 LS 12 g/h + UV 48W	74686	1	13.50	0.187
AP NEO-S2 LS 24 g/h + UV 56W	74687	1	14.00	0.187
AP NEO-S2 32 LS g/h + UV 56W	74688	1	15.50	0.187
AP NEO-S2 12 LS g/h + UV 48W + pH	74689	1	14.00	0.187
AP NEO-S2 24 LS g/h + UV 56W + pH	74690	1	14.50	0.187
AP NEO-S2 32 LS g/h + UV 56W + pH	74691	1	15.00	0.187
AP NEO-S2 12 LS g/h + UV 48W + pH/ORP	74692	1	14.50	0.187
AP NEO-S2 24 LS g/h + UV 56W + pH/ORP	74693	1	15.00	0.187
AP NEO-S2 32 LS g/h + UV 56W + pH/ORP	74694	1	17.00	0.187
Neolysis 2 (standard salinity)				
AP NEO-S2 12 g/h + UV 48W	74695	1	13.50	0.187
AP NEO-S2 24 g/h + UV 56W	74696	1	14.00	0.187
AP NEO-S2 32 g/h + UV 56W	74697	1	15.50	0.187
AP NEO-S2 12 g/h + UV 48W + pH	74698	1	14.00	0.187
AP NEO-S2 24 g/h + UV 56W + pH	74699	1	14.50	0.187
AP NEO-S2 32 g/h + UV 56W + pH	74700	1	15.00	0.187
AP NEO-S2 12 g/h + UV 48W + pH/ORP	74701	1	14.50	0.187
AP NEO-S2 24 g/h + UV 56W + pH/ORP	74702	1	15.00	0.187
AP NEO-S2 32 g/h + UV 56W + pH/ORP	74703	1	17.00	0.187
Optional:				
Relay Box (for pool equipment control)	72454	1	9.50	-
S-Driver® modules:				
SD-pH	70049	1	0.80	0.006
SD-Pump	70054	1	0.80	0.06
SD-ORP	70051	1	0.80	0.006
SD-PPM	70052	1	6.00	0.051
SD-VSP	73471	1	0.80	0.002



70049



70051



70052



73471

+ Heliox UV LP systems (LP = Low Pressure) are designed to be used in residential pools. They work on a wavelength of 254 nm, which is ideal for removing microorganisms. They will enable you to benefit from the latest ultraviolet light technology in the field of water treatment.

DESCRIPTION

- Stainless steel and polyethylene versions.
- Double lamp version (LP30 and LP30+).
- Plastic injection power box.
- Fluidra technology (design and manufacturing).
- Lamp "ON" indicator.
- Electronic counter for working time and ignitions (lamp lifetime control).
- Flow switch (optional, included in LP+ versions).
- LP+ versions come with a built-in pH/ORP controller (complete package).
- LP+ versions come with a flow switch, pH/ORP sensors and sensor holder (dosing pumps not included).



Heliox UV LP S.S. (Stainless Steel)



	Code	Standard Pack	Standard weight in kg	Standard volume in m ³
Heliox UV LP S.S. (Stainless Steel)				
Heliox UV LP 10	52206	1	11.80	0.153
Heliox UV LP 14	52207	1	12.00	0.153
Heliox UV LP 25	52208	1	15.00	0.187
Heliox UV LP 30	52209	1	15.60	0.187
Version with pH/ORP Control (LP+)				
Heliox UV LP 10 +	52210	1	12.10	0.153
Heliox UV LP 14 +	52211	1	12.40	0.153
Heliox UV LP 25 +	52212	1	16.00	0.187
Heliox UV LP 30 +	52213	1	16.50	0.187



Heliox UV LP PE (PolyEthylene)



	Code	Standard Pack	Standard weight in kg	Standard volume in m ³
Heliox UV LP PE (Polyethylene)				
Heliox UV LP P10	52214	1	7.90	0.153
Heliox UV LP P14	52215	1	8.10	0.153
Heliox UV LP P20	52216	1	9.20	0.187
Heliox UV LP P25	52217	1	9.60	0.187
Version with pH/ORP Control (LP+)				
Heliox UV LP P10 +	52218	1	8.10	0.153
Heliox UV LP P14 +	52219	1	8.30	0.153
Heliox UV LP P20 +	52220	1	10.80	0.187
Heliox UV LP P25 +	52221	1	11.15	0.187

TECHNICAL FEATURES

Material	Code	Model	Code	Model	Flow rate (30 mJ/cm ²)	Num. lamps	Rated / UV-C power	Total height (mm)	Ø reactor
Stainless steel	52206 & 52210	UV LP 10	52210	UV LP 10+	10 m ³ /h	1	48 / 13 W	790	204
Stainless steel	52207 & 52211	UV LP 14	52211	UV LP 14+	14 m ³ /h	1	56 / 18 W	790	204
Stainless steel	52208 & 52212	UV LP 25	52212	UV LP 25+	25 m ³ /h	1	90 / 30 W	1033	204
Stainless steel	52209 & 52213	UV LP 30	52213	UV LP 30+	30 m ³ /h	2	2 x 75 / 2 x 25 W	1033	204
PE	52214 & 52218	UV LP P10	52218	UV LP P10+	10 m ³ /h	1	48 / 13 W	735	200
PE	52215 & 52219	UV LP P14	52219	UV LP P14+	14 m ³ /h	1	56 / 18 W	735	200
PE	52216 & 52220	UV LP P20	52220	UV LP P20+	20 m ³ /h	1	75 / 25 W	978	200
PE	52217 & 52221	UV LP P25	52221	UV LP P25+	25 m ³ /h	1	90 / 30 W	978	200



Lyriox UV-C

- + Affordable & sustainable UV-C treatment solution for pools & spas.
- + Eco-friendly sanitation : drastically reduces the use of residual disinfection products.
- + Compact & easy to install.

DESCRIPTION

- Corrosion free : 100% made of PVC, hence suitable for use in combination with salt water
- Integrated ballast casing
- Also exists in a compact U-shape version for easier installation (50W model)
- UV-C high quality lamps (9 000 h).
- Provided with 50mm or 63mm unions (depending on model) to ease installation.

	Code	Standard Pack	Standard weight in kg	Standard volume in m ³
Lyriox UV-C 15W	82100	1	-	-
Lyriox UV-C 25W	82101	1	-	-
Lyriox UV-C 30W	82102	1	-	-
Lyriox UV-C 50W Compact	82103	1	-	-
Lyriox UV-C 55W	82104	1	-	-
Lyriox UV-C 75W	82105	1	-	-
Lyriox UV-C 110W	82106	1	-	-

TECHNICAL FEATURES

Code	Flow rate for 30 mJ/cm ² (m ³ /h)	Max. flow rate (m ³ /h)	Rated UV-C power (Watt)	Piping Connection	Reactor material	Lamp service life
82100	2	7	15	50mm	PVC	9 000 h
82101	2	10	25	50mm	PVC	9 000 h
82102	4	15	30	50mm	PVC	9 000 h
82103	5	15	50	50mm	PVC	9 000 h
82104	8	20	55	50mm	PVC	9 000 h
82105	10	25	75	63mm	PVC	9 000 h
82106	15	25	119	63mm	PVC	9 000 h



UV-C TL

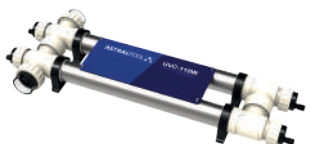

DESCRIPTION

The Astral UV-C TL ensures that your pool water is kept clean, fresh and crystal clear at all times in the most efficient, environmentally friendly way possible. Easy to install and maintain. It has a built-in electronic ballast for running the power pack without problems. In addition, the stainless steel reactor reflects UV-C rays, thus increasing efficiency by as much as 35%. The 30 and 55 Watt versions have a single lamp, whilst the 110-Watt version has two 55-Watt lamps in dual housing to increase contact time. Max. pressure: 2 bar. Comes with 3 connections (one closed with a blind cover) for easy installation. Also includes adaptors from Ø 63 mm to Ø 50 mm, with 1/2" female thread. The reactor must be wired to earth.

	Code	Standard Pack	Standard weight in kg	Standard volume in m ³
Astral UVC-30W TL	71427	1	-	-
Astral UVC-55W TL	71428	1	-	-
Astral UVC-110W TL	71429	1	-	-

TECHNICAL FEATURES

Code	Flow rate of 30 mJ/cm ²	Max. flow rate m ³ /h	Watt	Connection	Reactor material	Lamp service life
71427	8 m ³ /h	23	30	63/50/1.5"	316L	9000 h
71428	13 m ³ /h	23	55	63/50/1.5"	316L	9000 h
71429	20 m ³ /h	23	110 (2 x 55)	63/50/1.5"	316L	9000 h

Neolysis & Neolysis 2 lamps



	Code	Standard Pack	Standard weight in kg	Standard volume in m ³
48-W UV LP-10 lamps	60559	1	0.10	0.016
56-W UV LP-14 lamps	60606	1	0.12	0.016
UV LP-10/14 quartz	60607	1	0.08	-

Neolysis & Neolysis 2 electrodes

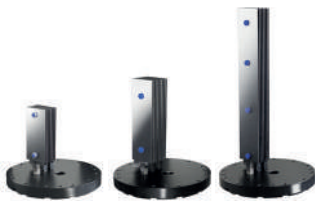

	Code	Standard Pack	Standard weight in kg	Standard volume in m ³
12 gr/h Neolysis LS electrode	61116	1	0.88	0.064
24 gr/h Neolysis LS electrode	61117	1	1.15	0.064
32 gr/h Neolysis LS electrode	61118	1	1.85	0.064
12 gr/h Neolysis (6 gr/l) electrode	67807	1	0.70	0.064
24 gr/h Neolysis (6 gr/l) electrode	67808	1	1.00	0.064
32 gr/h Neolysis (6 gr/l) electrode	67809	1	1.70	0.064

Heliox UV LP lamps



	Code	Standard Pack	Standard weight in kg	Standard volume in m ³
48-W UV LP-10 lamps (Codes 52206, 52210, 52214, 52218)	60559	1	0.10	0.016
56-W UV LP-14 lamps (Codes 52207, 52211, 52215, 52219)	60606	1	0.12	0.016
75-W UV LP-20 lamp (Codes 52216, 52220)	60608	1	0.20	0.022
90-W UV LP-25 lamp (Codes 52208, 52212, 52217, 52221)	60609	1	0.12	0.022
Kit of 2 x 75-W UV LP replacement lamps (Cod. 52209, 52213)	60637	1	0.24	0.045
UV LP-10/14 quartz (lamps 48 W and 56 W)	60606	1	0.08	0.016
UV LP-20/25/30 quartz (lamps 75 W and 90 W)	60631	1	0.09	0.022

MODEL COMPARISON

Product platform name	Control Connect			Dual Basic Plus		Basic Plus			Basic Next		
Product name	Control Connect			Dual pH-EV Basic Control Plus		Control Basic Plus		Redox Basic EV Plus	Control Basic Next		Redox Basic EV Next
Regulation type	pH & chlorine liquid dosing			pH & electrolysis control		pH or chlorine liquid dosing		Electrolysis management	pH or chlorine liquid dosing		Electrolysis management
Measure technology	pH	ORP	PPM	pH	ORP	pH	ORP	ORP	pH	ORP	ORP
Built-in dosing pump type	-			Peristaltic	-	Peristaltic	Peristaltic	-	Peristaltic	Peristaltic	-

Power pack

User interface	2,8" Oled touchscreen			LCD screen		LCD screen		LCD screen	LCD screen		LCD screen
Dosing pump (L/h)	-			0.4 or 1.5	-	1.5 or 5.0	1.5 or 5.0	-	0.4, 1.5 or 3.0	0.4, 1.5 or 3.0	-
Main on/off switch	✓			✓		✓		✓	✓		✓
Over-feed alarm	✓			✓		✓		✓	✓		✓
Alarm relay (for remote info)	-			✓		✓		✓	-		-
Water temperature	✓			✓ (optional PT100 input)		✓ (optional PT100 input)		✓ (optional PT100 input)	-		-
Inputs - Outputs	4 (digital) - 4 (relays)			-		-	-	-	-	-	-

Sensors / Regulation

Sensor(s) provided	✓ (pH & ORP or pH & PPM)			✓	✓	- (pH kit)	- (ORP kit)	- (ORP kit)	✓	✓	✓
Sensor(s) installation	In line or Panel (depends on model)			In line	In line	In line	In line	In line	In line	In line	In line
Range measurement	0.0-9.9 pH	0-999 mV	0.0-5.0 ppm	0.0-14.0 pH	0-999 mV	0.0-14.0 pH	0-999 mV	0-999 mV	0.0-14.0 pH	0-1000 mV	0-1000 mV
Automatic calibration	✓	✓	✓	✓	✓	✓	✓	✓	✓	✓	✓

Connectivity / App control

NN Thing (Connect & Go automation)									-	-	-
Poolstation app				-	-	-	-	-	-	-	-
Warranty	3 years			2 years		2 years		2 years	2 years		2 years

Control Connect

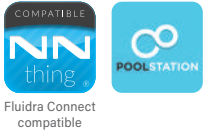

DESCRIPTION

A fully automated multi-parameters control unit for a balanced and disinfected swimming pool. A range of models suitable to different needs with either pH & ORP automatic regulations and dosing or pH & PPM free chlorine automatic regulations.

- Connected product using built-in Ethernet port and PoolStation app (available on iOS & aOS).
- NN compatible: Smart control within Fluidra Connect pool automation and NN app (available on iOS & aOS).
- Available in stand-alone version (code 71537) or in a complete panel version with low flow chamber (codes 71538 & 71539).
- 2.8" TFT colour touchscreen.
- 4 digital inputs and 4 digital outputs (relays) to control the filter pump, heat pump, lighting, refill system, etc.
- Water temperature reading as standard.
- Equipped with a flow switch as standard.
- Equipped with dedicated outputs for pH & chlorine dosing pumps.
- pH and chlorine dosing pumps NOT included to give maximum flexibility depending on pool type. Kit 70054 can be used (1.5 L/h peristaltic pumps).



	Code	Standard Pack	Standard weight in kg	Standard volume in m ³
pH / ORP / Temp. stand-alone	71537	1	5.85	0.047
pH / ORP / Temp. complete panel	71538	1	6.85	0.079
pH / PPM / Temp. complete panel	71539	1	6.85	0.079
Optional				
SD-Pump	70054	1	0.80	0.06
Relay Box (for pool equipment control)	72454	1	9.50	-
S-Driver® modules:				
SD-VSP	73471	1	0.80	0.002



70054



72454



73471



71537
pH/ORP/Temp.
stand-alone



71538
pH/ORP/Temp.
complete panel



71539
pH/PPM/Temp.
complete panel

Relay Box

Elite Connect, Neolysis 2, Control Connect



DESCRIPTION

Pre-wired cabinet that facilitates the installation between Elite Connect, Neolysis 2 or Control Connect and the pool equipment that can be controlled using 4 power outputs (filter pump, heater, lighting, etc.). See Elite Connect on page 268, Neolysis 2 on page 274 and Control Connect on page 279.

- IP55 watertight casing.
- All outputs are protected by a fuse.
- Control features :
 - 1 x 230 Vac output for :
 - Filter pump up to 3 HP
 - Or any device up to 10A / 2.3 kW
 - 3 x 230 Vac outputs for :
 - Filter pump up to 1/3 HP
 - Any device up to 6.5A / 1.5 kW

	Code	Standard Pack	Standard weight in kg	Standard volume in m ³
Relay Box	72454	1	9.5	-

Dual pH-EV Basic Control Plus



DESCRIPTION

The DUAL pH-EV Basic Control Plus dosing device has been specifically designed for automatically controlling pH and ORP levels. It is a must in home spas and pools. It can work with a salt chlorinator or chlorine tablets, as it has relay output for enabling the chlorinator, in addition to controlling a pool's pH levels through a peristaltic pump.

Small in size, it comes with all of the components required for proper installation. Depending on the device that has been connected, the control function can be set to the ON-OFF setting or proportional setting (ideal for solenoid valves).

General technical features

- Automatic pH or redox control and dosing system.
- Measurement range of 0-14 (pH) and 0-100 mV (redox).
- Includes full installation kit comprising a pH and Redox sensor, sensor holder, standard solutions, suction and blow pipes and suction- and blow-pipe fittings.
- ABS casing with IP65 protection rating.
- Digital screen that gives pH, redox (ORP) and temperature (optional Pt100) readings
- Remote on-off input (230 VAC) that keeps display lit up for calibration and programming.
- Chemical product level inlet.
- Alarm relay.

	Code	Standard Pack	Standard weight in kg	Standard volume in m ³
Dual pH-EV Basic Control 1.5 l/h compatible with Fluidra Connect (includes sensors)	66180	1	-	-
SPA pH-EV 0.4 l/h Dual Basic Control compatible with Fluidra Connect (includes sensors)	66181	1	-	-
Optional				
PT100 sensor	66758	-	-	-
Flange for PT100	66759	-	-	-

Control Basic Plus



Fluidra Connect compatible

Check sensors and installation kit on page 282

DESCRIPTION

Small in size, it has been designed to prevent siphoning, require little maintenance, be easy to install and is protected from the spraying of chemical products. The device automatically measures and checks a pool's pH or ORP level.

Supplied without sensors or calibration solutions. Installation kit included.

- Plastic housing with IP-65 protection rating
- Backlit LCD display comprising 2 lines and 16 characters.
- Self-calibration of sensors.
- Quality control of sensors.
- Dosing pause during alarms and notification by a blinking LED.
- Proportional dosing.
- Adjustable set point.
- Flow rate: 1,5 l/h or 5 l/h.
- Back pressure: 1.5 bar.
- pH measurement range: 0.00 to 14.00.
- Redox measurement range: -999 to + 999 mV.
- Switch.
- Alarm relay.
- Minimum chemical product level input.
- PT100 temperature inlet (optional sensor).

	Code	Standard Pack	Standard weight in kg	Standard volume in m ³
Control Basic 1,5 l/h	66159	1	2.2	0.01
Control Basic 5,0 l/h	66160	1	2.2	0.01
pH sensor with calibration solutions	36004	1	0.4	0.001
Redox sensor with calibration solutions	36005	1	0.3	0.001
Optional				
PT100 sensor	66758	-	-	-
Flange for PT100	66759	-	-	-



Fluidra Connect compatible

Check sensors and installation kit on page 282

Redox Basic EV Plus

DESCRIPTION

Small in size, it has been designed to prevent siphoning, require little maintenance, be easy to install and is protected from the spraying of chemical products. Recommended for use with any chlorinator without ORP regulation.

Supplied without sensors or calibration solutions. Installation kit included.

- Plastic housing with IP-65 protection rating
- Backlit LCD display comprising 2 lines and 16 characters.
- Self-calibration of sensors.
- Quality control of sensors.
- Dosing pause during alarms and notification by a blinking LED.
- Proportional dosing.
- Adjustable set point.
- Redox measurement range: -999 to + 999 mV.
- Switch.
- Alarm relay.
- Output relay for external component.
- Minimum chemical product level input.
- PT100 temperature input (optional sensor).

	Code	Standard Pack	Standard weight in kg	Standard volume in m ³
Redox Basic EV Plus, sensor not included	66161	1	2.1	0.01
Redox sensor with calibration solutions	36005	1	0.3	0.001
Optional				
PT100 sensor	66758	-	-	-
Flange for PT100	66759	-	-	-

Control Basic Next



DESCRIPTION

The Control Basic Next device has been specifically designed for the automatic control of pH and redox levels. It can be set to control whichever of these two functionalities is required.

It is the most simple control and dosing device in the market. Small in size, it has all of the components required for immediate installation.

General technical features

- Automatic pH or redox control and dosing system.
- Measurement range of 0-14 (pH) and 0-100 mV (redox).
- It comes with a full installation kit, made up of a pH or redox sensor (depending on the model), a sensor holder, standard solutions, suction and blow pipes, and suction and blow pipe fittings.
- ABS casing with IP65 protection rating.
- Digital display screen for both pH and redox readings.
- Remote on-off input (230 VAC) that keeps display lit up for calibration and programming.

	Code	Standard Pack	Standard weight in kg	Standard volume in m ³
Control Basic pH 1.5 l/h NEXT (pH sensor included)	66162	1	-	-
Control Basic pH 3 l/h NEXT (pH sensor included)	66336	1	-	-
Control Basic ORP 1.5 l/h NEXT (ORP sensor included)	66163	1	-	-
Control Basic ORP 3 l/h NEXT (ORP sensor included)	66337	1	-	-
Control Basic pH 0.4 l/h NEXT SPA (pH sensor included)	66156	1	-	-
Control Basic ORP 0,4 l/h NEXT SPA (ORP sensor included)	66157	1	-	-

Redox Basic EV Next



DESCRIPTION

The Redox Basic EV Next device has been specifically designed for automatically controlling ORP levels. It is the most simple control and dosing device in the market. Small in size, it has all of the components required for immediate installation.

It can work with a salt chlorinator, a simple dosing pup or even chlorine tablets thanks to its relay output automatically enabling the sanitation feature when needed.

General technical features

- Automatic redox control and dosing system.
- Measurement range of 0-1000 mV.
- It comes with basic installation kit, made of an ORP sensor, a sensor holder and standard buffer solution (no piping kit as device is made to control a separate sanitizer appliance).
- ABS casing with IP65 protection rating.
- Digital screen that gives redox readings.
- Remote on-off input (230 VAC) that keeps display lit up for calibration and programming.

	Code	Standard Pack	Standard weight in kg	Standard volume in m ³
Redox Basic EV Next Includes redox sensor	66174	1	-	-

Installation kit



Sensors kits



	Installation kit	Sensors kits
Control Basic Next	<input type="checkbox"/> <input type="checkbox"/> <input type="checkbox"/> <input type="checkbox"/> <input type="checkbox"/>	pH sensor with calibration solutions (Code: 36004) <input type="checkbox"/>
Redox Basic EV next	<input type="checkbox"/> <input type="checkbox"/>	Redox sensor with calibration solutions (Code: 36005) <input type="checkbox"/>

- The OPTIMA dosing pumps reduce the number of pumps required to meet the various dosing needs.
- The OPTIMA dosing pump series, with its 90-265 VAC / 50-60 Hz power supply technology, ensures a precision and reliability never seen before.
- Integration of many functions thanks to its simple programming, an alphanumeric display, the possibility of multilingual programming of the menu and a technology which permit controlled flow rate and back pressure.
- Allows to use the same model for various applications providing a great versatility.
- IPX5 protection.
- Components in contact with chemicals are made of polypropylene, Viton, Teflon and PVC.
- Acid-resistant casing.
- Moisture-resistant membrane push buttons.
- Built-in purge valve.
- No lubrication and little maintenance work required.
- Sensors and calibration solutions not included.

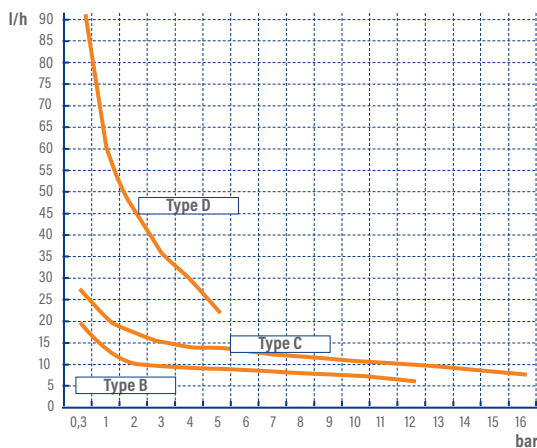

Sensors kits

				
pH sensor with calibration solutions (Code: 36004)	■		■	
Redox sensor with calibration solutions (Code: 36005)		■		■



Optima constant flow rate

analogue dosing pump



DESCRIPTION

In OPTIMA constant flow rate analogue dosing pumps, the flow rate can be set as a percentage using the potentiometer under the front panel, which modifies the pump's operation frequency.

The pumps in this range have an level inlet sensor.

Double scale adjustment: the maximum dosing frequency can be divided into 5. This double scale allows users to have two pumps with a single unit.

Power supply from 90 to 230 VCA at 50-60 Hz with plug and switch



	Code	Standard Pack	Standard weight in kg	Standard volume in m ³
Adjustable manual Optima pump				
B-type pump of 5-10 bar and 2-5 l/h	57132	1	3.5	0.01
C-type pump of 5 bar and 10 l/h	57133	1	4.5	0.01
D-type pump of 5 bar and 120 l/h	57135	1	4.5	0.01

Optima Next constant flow rate analogue dosing pump



DESCRIPTION

The flow rate is fully adjustable from the flow meter. Power supply from 90 to 230 VCA at 50-60 Hz without plug.

	Code	Standard Pack	Standard weight in kg	Standard volume in m ³
Adjustable Optima manual pump at 8 bar and 5 l/h	66164	1	-	-

Optima proportional and volumetric dosing pump



DESCRIPTION

OPTIMA pumps provide all the functions of proportional dosing in a single model.

Features:

- Proportional with analogue signals 4 - 20 mA.
- Proportional with digital signals and the possibility of:
- Multiplying the input impulses (1:n)
- Dividing the input impulses (n:1)
- Function in ppm
- The pump has a memory function for processing input impulses dosing
- Level alarm with pump disconnection.
- Maximum dosing flow rate to prevent overdosing.
- Password for protecting programmed data
- Possibility of alarm connection
- Power supply from 90 to 265 VCA at 50-60 Hz with plug

	Code	Standard Pack	Standard weight in kg	Standard volume in m ³
Type B Model 7-10 bar and 5 litres	57136	1	3.5	0.01
Type C Model 5 bar and 10 litres	57137	1	4.5	0.01
Type D Model 5 bar and 20 litres	57138	1	4.5	0.01

Optima Next proportional and volumetric dosing pump



DESCRIPTION

OPTIMA pumps provide all the functions of proportional dosing in a single model.

Features:

- Proportional with analogue signals 4 - 20 mA.
- Reading of pulses/minute.
- Chemical product minimum level inlet.
- Pulse entry for dosing proportional from pulse emitter counter.
- Remote start/stop.
- Power supply from 90 to 265 VCA at 50-60 Hz without plug.

	Code	Standard Pack	Standard weight in kg	Standard volume in m ³
Model 8 bar and 5 litres	66165	1	-	-

DOSING PUMPS

Optima Plus dosing pump

with pH or ORP regulation



Fluidra Connect compatible

Sensor not included
(see sensors on page 283)
Sensor holder not included
(code 01306)

DESCRIPTION

OPTIMA dosing pump with built-in pH/Redox control. pH/Redox instrument.

Automatic calibration: Calibration by simply pressing a button, with the possibility of controlling the level of sensor efficiency.

Features:

- 90-265 VAC 50/60 Hz power supply
- Manual temperature compensation for pH or optionally automatic via Pt100.
- 4-20mA output for printed register or transmission of the reading.
- Level alarm with pump disconnection or simple warning of lack of product by means of the alarm relay.
- Alarm notifying deactivation of the programmable setpoint across whole of the measurement range.
- Dosing delay time to stop the dosing pump from injecting product in event of sensor malfunction.
- Maximum dosing pump flow rate for preventing overdosing.
- Password for protecting programmed data.
- Possibility of alarm connection.

	Code	Standard Pack	Standard weight in kg	Standard volume in m ³
Type C Optima Redox/pH control dosing pump (10 bar and 5 l/h and 5 bar and 10 l/h)	66179	1	4.5	0.01
pH sensor with calibration solutions	36004	1	0.4	0.001
Redox sensor with calibration solutions	36005	1	0.3	0.001
Optional				
PT100 sensor	66758	-	-	-
Flange for PT100	66759	-	-	-

Optima Next dosing pump

with pH or ORP regulation



Sensor not included
(see sensors on page 283)
Sensor holder not included
(code 01306)

DESCRIPTION

OPTIMA dosing pump with built-in pH/Redox control instrument.

Automatic calibration by simply pressing a button, with the possibility of controlling the degree of sensor efficiency.

Features:

- Power supply from 90 to 265 VCA at 50-60 Hz without plug
- Manual temperature adjustment for pH or optional automatic adjustment with PT100 (sensor not included).
- Level control input.
- Remote off control.

	Code	Standard Pack	Standard weight in kg	Standard volume in m ³
Optima Next dosing pump redox control/pH control at 8 bar and 5 l/h	66166	1	-	-
pH sensor with calibration solutions	36004	1	0.4	0.001
Redox sensor with calibration solutions	36005	1	0.3	0.001

Bracket for mounting above tank



DESCRIPTION

Optional support for mounting the OPTIMA series and pH Basic horizontally; for example, above chemical solution tanks.

	Code	Standard Pack	Standard weight in kg	Standard volume in m ³
	36830	1	0.1	0.002

Peristaltic dosing pumps



DESCRIPTION

90/260V 50/60 Hz electrical connection.

The installation kit includes:

- Transparent glass-type flexible 2-m PVC suction pipe.
- Semi-rigid white polyethylene 2-m return pipe.
- 3/8" BSP m. injection valve.
- Pool floor filter.

	Code	Standard Pack	Standard weight in kg	Standard volume in m ³
Peristaltic pump 4 l/h (3 bar)	57179	1	-	-
Peristaltic pump 12 l/h (1 bar)	57178	1	-	-

Polyethylene cylindrical tanks



DESCRIPTION

To hold chemicals for dosage pumps.

	Code	Standard Pack	Standard weight in kg	Standard volume in m ³
Capacity: 125 l	01314	1	4.5	0.120
Capacity: 250 l	01315	1	10.0	0.390
Capacity: 350 l	01316	1	14.0	0.510
Capacity: 500 l	01317	1	21.5	0.760
Capacity: 1000 l	28831	1	-	-

Manual stirrer



DESCRIPTION

For Polyethylene tanks.

	Code	Standard Pack	Standard weight in kg	Standard volume in m ³
Length 60 cm	01318	1	0.5	0.010
Length 90 cm	01319	1	1.2	0.020

Floating dispenser



36620

69668



38630

38629

DESCRIPTION

Allows for dosing and easy chemical product handling in the pool.

	Code	Standard Pack	Standard weight in kg	Standard volume in m ³
Shark Series Floating dispenser for 200 g tablets	36620	12	8.0	0.14
Blue Line Dispenser with tablet level indicator	69668	12	3.8	0.067
Basic Line Floating dispenser for 200 g tablets	38630	12	4.0	0.079
Floating dispenser for 20 g tablets	38629	12	4.0	0.030



Dossi-5 and Dossi-10 in-line

Bromine feeders

DESCRIPTION

Bromine dispenser. Manufactured from unalterable plastic materials (ABS). With regulation valve, manual purge, Venturi automatic depression purge, and opening key. For pools up to 45 m³ with the Dossi-5 dispenser and up to 90 m³ Dossi-10 dispenser. Connections 1½". Ø 200 mm.

	Code	Standard Pack	Standard weight in kg	Standard volume in m ³
Dossi-5 in-line. Height 486 mm Approximate capacity: 5 kg of tablets	21438	1	3.7	0.031
Dossi-10 in-line. Height 725 mm Approximate capacity: 10 kg of tablets	21439	1	4.8	0.049



Dossi-5 and Dossi-10 off-line

Chlorine and bromine feeder

DESCRIPTION

Bromine and chlorine feeder. Manufactured from unalterable plastic materials (ABS). Approximate capacity: 5 kg of tablets for Dossi-5 and 10 kg for Dossi-10. Supplied with two valves in order to stop the water flow. Height 486 mm and Ø 200 mm. Connections Ø 20 mm.

	Code	Standard Pack	Standard weight in kg	Standard volume in m ³
Dossi-5 off-line for pools up to 100 m ³	01413	1	3.7	0.031
Dossi-10 off-line for pools up to 200 m ³	43998	1	4.86	0.048

TECHNICAL FEATURES

	Volume of chlorine-treated pools	Volume of bromine-treated pools
Dossi 5	20 m ³ - 80 m ³	4 m ³ - 50 m ³
Dossi10	20 m ³ - 160 m ³	4 m ³ - 100 m ³

3.5 kg Dossi-3

Chlorine and bromine feeder



DESCRIPTION

Chlorine and bromine feeder. Manufactured from unalterable plastic materials (ABS). Approximate capacity: 3.5 kg of tablets. Lid closing with double safety system. Easy to operate regulation valves. For pools up to 60 m³ with Chlorine and up to 30 m³ with bromine. Height: 405 mm.

	Code	Standard Pack	Standard weight in kg	Standard volume in m ³
Dossi-3 in-line For direct connection to pipework with 1½" connectors	24429	1	1.81	0.03
Dossi-3 off-line For by-pass connection with flexible tube	24430	1	1.90	0.031

Code 24429 IN-LINE

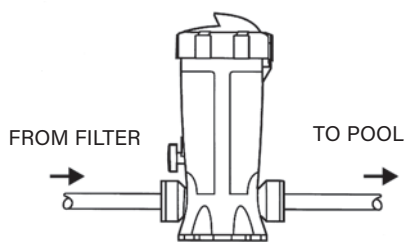

Code 24430 OFF-LINE

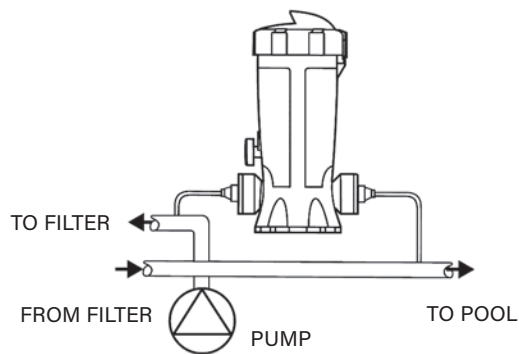

DOSING EQUIPMENT

INSTALLATION DIAGRAM OF CHLORINE/BROMINE DOSING UNITS AND AUTOMATIC REGULATING AND CONTROL EQUIPMENT

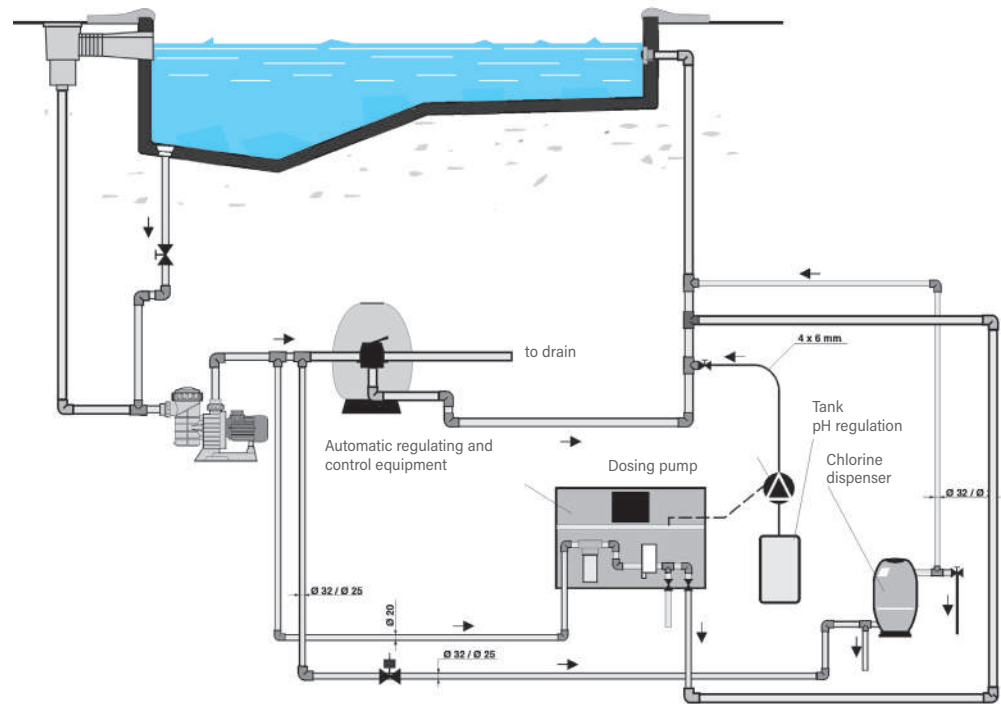

Compact dosage tank



DESCRIPTION

Trichlor and bromine tablet dosage unit with automatic safety valve. Made out of fibreglass and polyester.

	Code	Standard Pack	Standard weight in kg	Standard volume in m ³
Compact dosage tank 40 l Trichlor (for pools from 200 to 500 m ³) Bromine (for pools from 150 to 300 m ³)	16631	1	15	0.134
Compact dosage tank 60 l Trichlor (for pools from 500 to 1000 m ³) Bromine (for pools from 300 to 450 m ³)	16632	1	18	0.190



Degassing valve kit



DESCRIPTION

Degassing valve, with a spring. Opening pressure 2.5 to 3.5 bar (Kg/cm²). For Chlorimax filters.

	Code	Standard Pack	Standard weight in kg	Standard volume in m ³
For 40 l dosage tank	16633	1	0.4	0.002
For 60 l dosage tank	16634	1	0.4	0.002

Woltman type turbine meters



DESCRIPTION

Woltman type axial turbine water meter, with numerical counter readout, and numbered drums. Dry dial with magnetic transmission. Easily removable gearwork and turbine. Pre-set for pulse emission. IP-68 protection level. CYBLE type pulse emission.

	Code	Standard Pack	Standard weight in kg	Standard volume in m ³
2" gauge - 50 mm	20430	1	12.0	0.004
2½" gauge - 65 mm	20431	1	13.6	0.004
3" gauge - 80 mm	20432	1	14.6	0.004
4" gauge - 100 mm	20433	1	20.0	0.006
5" gauge - 125 mm	20434	1	30.0	-
6" gauge - 150 mm	20435	1	36.0	0.009
8" gauge - 200 mm	20436	1	55.0	0.012
CYBLE type emitter K= 1 l/pulse	23235	1	-	-
CYBLE type emitter K= 10 l/pulse	23235-0010	1	-	-
CYBLE type emitter K= 100 l/pulse	23235-0100	1	-	-

Electrically driven plastic valves - Nylon



DESCRIPTION

Threaded connection. Manually operated ON position Flow regulator. Stainless Steel AISI-302 spring. Maximum working pressure = 10 atm.

	Code	Standard Pack	Standard weight in kg	Standard volume in m ³
1½" connections	09392	1	0.5	-
2" connections	56116	1	0.7	-
3" connections	57641	1	1.1	-

TECHNICAL FEATURES

MODELS	09392	56116	57641
Connection	1½"	2"	3"
Min. pressure kg/cm ²	1	1	1
Max. pressure kg/cm ²	10	10	10
Maximum flow m ³ /h	30	40	60

Pressure and flow diagrams

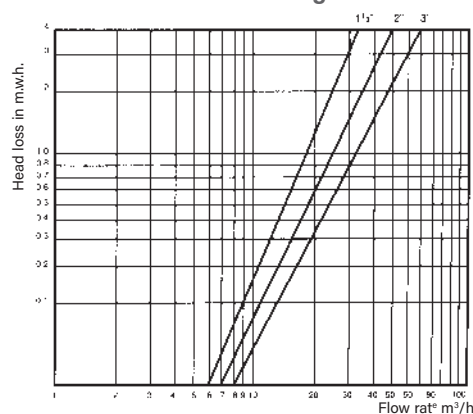

24 Volt solenoids



DESCRIPTION

To install in electric valves with code 09392, 06935 and 06936.

	Code	Standard Pack	Standard weight in kg	Standard volume in m ³
	09393	1	-	-

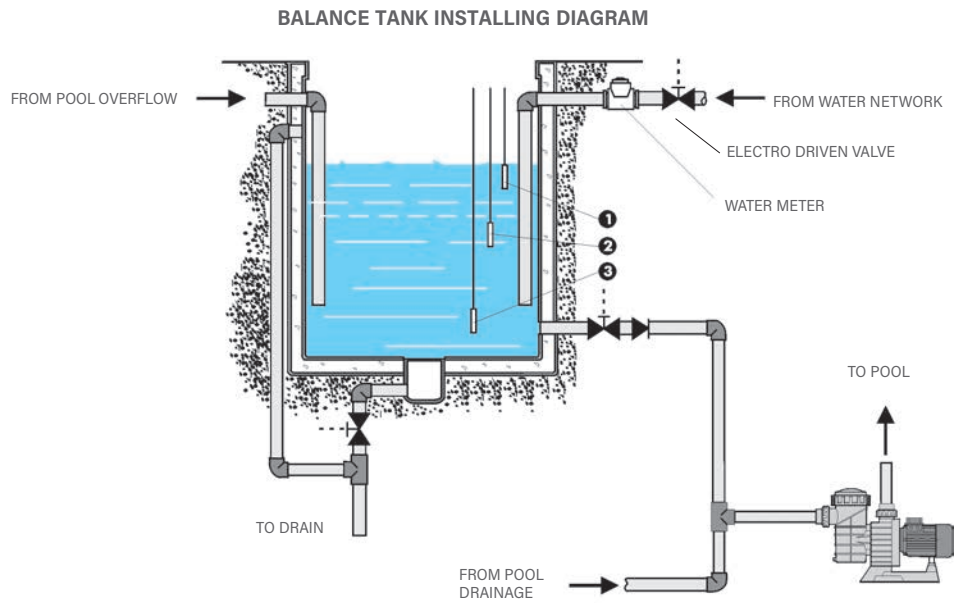

- ❶ Maximum water level signal in BALANCE TANK for starting the pumping system
- ❷ Minimum water level signal in POOL for opening the electrically operated valve for make-up water.
- ❸ Minimum level signal in BALANCE TANK for shutting down the pumping system.

Electronic operating panel for overflow pool balance tank



DESCRIPTION

For overflow pool. Water level sensor with 2 m cable.

For 2 water levels control panel:

- Minimum safety level for pump operation: The pump stops working if water level doesn't have the minimum set level.
- Top-up level, whereby a signal is sent to the solenoid valve to top up the level of water in the pool. Signal to the valve at 220 V II and 24 V II.

	Code	Standard Pack	Standard weight in kg	Standard volume in m ³
	12061	1	-	-

3 water level control panel:

- Minimum safety level for pump operation: The pump stops working if water level reaches the minimum set level.
- Water make up level: Gives the solenoid water inlet valve, the opening signal to keep correct water level in balance tank. Solenoid valve signal in 220 V II & 24 V II.
- Forced start-up, so that the pump unit starts up when the balance tank overflows due to a burst pipe or non-return valve failure.

	Code	Standard Pack	Standard weight in kg	Standard volume in m ³
Dual frequency (50/60 Hz)	12062	1	-	-



CLEANING



- | | | | |
|-----|--|-----|--|
| 294 | Pool cleaner accessories | 298 | Manual pool cleaners - Classic Range |
| 294 | Suction automatic pool cleaners | 302 | Net'n'Clean Integrated Cleaning System |
| 295 | Manual pool cleaners - Blue Line Range | 304 | Hoses |
| 297 | Manual pool cleaners - Shark Range | | |



Pump caddy

for stand-alone pool cleaners



DESCRIPTION

Made of anodized aluminium tube and a 460 mm x 370 mm plastic platform. Face plate in AISI-304 stainless steel.

Code	Standard Pack	Standard weight in kg	Standard volume in m ³
04648	1	8.06	0.12

SUCTION AUTOMATIC POOL CLEANERS

Splasher



DESCRIPTION

Splasher is an hydraulic suction cleaner. It's using the pool filtration system to work and collect the debris in the pump pre-filter.

It is simply connected to the skimmer vacuum plate and works at the same time than the pool filtration.

Its membrane system ensures an optimum and quieter performance.

- Cleaning areas: floor and walls.
- Pool floors types: flat or gentle slopes.
- Pool size: up to 9m length.
- Filter pump minimum required pressure: ½ HP.
- Included in pack : 9,6m hose.

	Code	Standard Pack	Standard weight in kg	Standard volume in m ³
Splasher suction cleaner	66281	1	5.6	0.05

Mamba



DESCRIPTION

Mamba is an hydraulic suction cleaner. It's using the pool filtration system to work and collect the debris in the pump pre-filter.

It is simply connected to the skimmer vacuum plate and works at the same time than the pool filtration.

The Mamba's dual suction design ensures the pump and filter are never starved of water. The adjustable bypass valve allows for operation from small to large capacity filtration pumps.

- Cleaning areas: floor and walls.
- Pool floors types: flat or gentle slopes.
- Pool size: up to 9m length.
- Filter pump minimum required pressure: ½ HP.
- Included in pack : 12 x 80 cm hose sections, flow regulator, universal adapter.

	Code	Standard Pack	Standard weight in kg	Standard volume in m ³
Mamba suction cleaner	60092	1	7	0.061

MANUAL POOL CLEANERS - BLUE LINE RANGE

Blue Line

manual suction cleaner - wing-nut fastening



69661



69673



69663



69664

	Code	Standard Pack	Standard weight in kg	Standard volume in m ³
1 1/2" 350 flexible pool cleaner	69661	6	6.6	0.053
1 1/2" 350 aluminium pool cleaner	69673	6	-	-
Triangular pool cleaner	69663	6	-	-
Oval pool cleaner	69664	6	-	-



69656



69658



69669

Blue Line

wall brush - wing-nut fastening



	Code	Standard Pack	Standard weight in kg	Standard volume in m ³
Adjustable handle wall brush (48 cm)	69656	12	2.5	0.04
Fixed handle wall brush (50 cm)	69658	12	3.9	0.04
Multifunction manual brush	69669	24	-	-

Blue Line leaf skimmer - wing-nut fastening



69665



69666



69667

	Code	Standard Pack	Standard weight in kg	Standard volume in m ³
Plastic flat leaf skimmer	69665	12	-	-
Plastic net leaf skimmer fixed handle	69666	12	-	-
Aluminium net leaf skimmer	69667	12	-	-

Blue Line handles - wing-nut fastening



69659 - 69660

	Code	Standard Pack	Standard weight in kg	Standard volume in m ³
1.8-3.6 m easy regulation aluminium handle	69659	12	-	-
2.4-4.8 m easy regulation aluminium handle	69660	12	-	-

Blue Line cleaning material wall bracket



	Code	Standard Pack	Standard weight in kg	Standard volume in m ³
Cleaning material wall bracket	69662	6	-	-

Blue Line floating dispenser



	Code	Standard Pack	Standard weight in kg	Standard volume in m ³
Floating dispenser for 200g tablets	69668	12	-	-

Shark pool cleaner - wing-nut or wishbone fixing



	Code	Standard Pack	Standard weight in kg	Standard volume in m ³
Shark Flexo pool cleaner	36618	6	9.9	0.04
Shark Oval pool cleaner	40997	5	6.4	0.04
Shark Triangular pool cleaner	36619	4	5.2	0.04



Shark brushes - wing-nut or wishbone fixing



	Code	Standard Pack	Standard weight in kg	Standard volume in m ³
Shark special bottom curved brush	36615	10	3.7	0.04
Shark bottom/walls curved brush	36616	15	4.2	0.04
Shark corner suction brush	36617	12	2.4	0.04

Shark leaf skimmers - wing-nut or wishbone fixing



	Code	Standard Pack	Standard weight in kg	Standard volume in m ³
Shark water surface leaf skimmer	36613	15	6.2	0.14
Shark deep water leaf skimmer	36614	15	6.5	0.14

Shark telescopic pole - wing-nut or wishbone fixing



	Code	Standard Pack	Standard weight in kg	Standard volume in m ³
Shark 1.8 - 3.6 m telescopic pole	38422	10	11.7	0.05
Shark 2.4 - 4.8 m telescopic pole	38423	10	14.4	0.06

Shark floating dispenser for 5 tablets



	Code	Standard Pack	Standard weight in kg	Standard volume in m ³
Floating dispenser for 5 tablets 200 g Shark	36620	12	6.6	0.14



Shark submersible analogue thermometer



	Code	Standard Pack	Standard weight in kg	Standard volume in m ³
Shark submersible analogue thermometer	36622	10	2.8	0.04



Classic pool cleaner - wing-nut fastening



01355 - 01356

	Code	Standard Pack	Standard weight in kg	Standard volume in m ³
Classic extruded aluminium pool cleaner 1 1/2" connection 350 mm	01355	4	10.2	0.04
Classic extruded aluminium pool cleaner 2" connection 450 mm	01356	4	12.2	0.06

Classic Flexo pool cleaner



	Code	Standard Pack	Standard weight in kg	Standard volume in m ³
Wishbone fixing	01351	4	7.2	0.04
Wing-nut fixing	01352	4	7.2	0.04

Classic brushes - wing-nut fastening



01405



01407



09456

	Code	Standard Pack	Standard weight in kg	Standard volume in m ³
Straight brush				
Classic PP bristle 330 mm	01405	20	2.8	0.04
Classic S.S. bristle 165 mm	01407	20	9.0	0.018
Classic PP bristle 180 mm	09456	14	6.1	0.177

Classic brush holder - wing-nut fastening



	Code	Standard Pack	Standard weight in kg	Standard volume in m ³
Classic water surface leaf skimmer with handle incorporated	01400	12	5	0.18

Classic fixed handle - wing-nut fastening



	Code	Standard Pack	Standard weight in kg	Standard volume in m ³
Classic fixed handle 2.5 m	01365	12	10.2	0.06

Classic pool cleaner - wishbone fixing



01353-01354-08661

	Code	Standard Pack	Standard weight in kg	Standard volume in m ³
Extruded aluminium pool cleaner				
1 1/2" connection 350 mm	01353	4	11.8	0.04
2" connection 450 mm	01354	4	15.5	0.06
1 1/2" connection 450 mm	08661	4	15.5	0.06

Classic



public pool aluminium pool cleaner - wishbone fixing

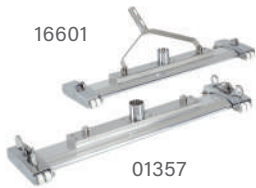

16601

01357



01358

	Code	Standard Pack	Standard weight in kg	Standard volume in m ³
Length: 800 mm				
Drag with cable (00210 not included)	01357	1	13.0	0.03
With nozzle	16601	1	13.0	0.03
Length: 450 mm				
With nozzle 1 1/2" - 2" connection	01358	4	13.6	0.05

Classic brushes - wishbone fixing



01406



01404

	Code	Standard Pack	Standard weight in kg	Standard volume in m ³
PP bristle 330mm straight brush	01406	20	2.8	0.04
Bottom/walls curved brush	01404	20	4	0.05
Floating line brush	11789	20	3.8	0.03

Classic leaf skimmers



01398



01396

	Code	Standard Pack	Standard weight in kg	Standard volume in m ³
Wishbone fixing				
Water surface leaf skimmer	01398	20	4.2	0.12
Deep water leaf skimmer	01396	20	4.3	0.12
Wing-nut fixing				
Water surface leaf skimmer	01399	20	4.3	0.12
Deep water leaf skimmer	01397	20	4.4	0.12



Classic fixed handle - wishbone fixing



	Code	Standard Pack	Standard weight in kg	Standard volume in m ³
Fixed handle 2.5 m	01364	20	11.4	0.06



Shark telescopic pole - wing-nut or wishbone fixing



	Code	Standard Pack	Standard weight in kg	Standard volume in m ³
Classic 1.8 - 3.6 m telescopic pole	01359	12	13.4	0.05
Classic 2.4 - 4.8 m telescopic pole	01360	12	16.2	0.06

Classic reinforced telescopic pole - Public pools



DESCRIPTION

Reinforced telescopic pole, aluminium



	Code	Standard Pack	Standard weight in kg	Standard volume in m ³
2.5 - 5 m	01361	5	16.0	0.04
3.75 - 7.5 m	15838	1	6.0	0.01
5 - 10 m	01362	1	6.5	0.02
6.5 - 13 m	01363	1	8.4	0.02

Hose adapter



DESCRIPTION

For connecting wing nut assembly to clip hose or clip assembly to wing nut hose.

	Code	Standard Pack	Standard weight in kg	Standard volume in m ³
Adapts the wishbone handle connection to wing-nut connection	08465	35	2.55	0.01
Adapts the reinforced pole connection to wing-nut connection	17937	38	2.66	0.01



Hose adapter

DESCRIPTION

For connecting wing nut assembly to clip hose or clip assembly to wing nut hose.

	Code	Standard Pack	Standard weight in kg	Standard volume in m ³
Adapts the connection hose clip to wing nuts	14592	48	3.36	0.01

Thermometers



DESCRIPTION

Celsius & Fahrenheit scale.

	Code	Standard Pack	Standard weight in kg	Standard volume in m ³
	20594	20	2.1	0.032

Integrated cleaning system

- The Net'N'Clean is an efficient cleaning system, consisting of a six outlet distributor valve that receives clean water from the filter and distributes it sequentially to a series of nozzles installed on the pool floor.
- This type of distribution from the bottom keeps the particles in suspension so they are collected by the skimmer and main drain and retained by the filter. It helps improve the use and efficiency of chemical products injected in the return piping and reduces heating costs by returning hot water along the bottom.

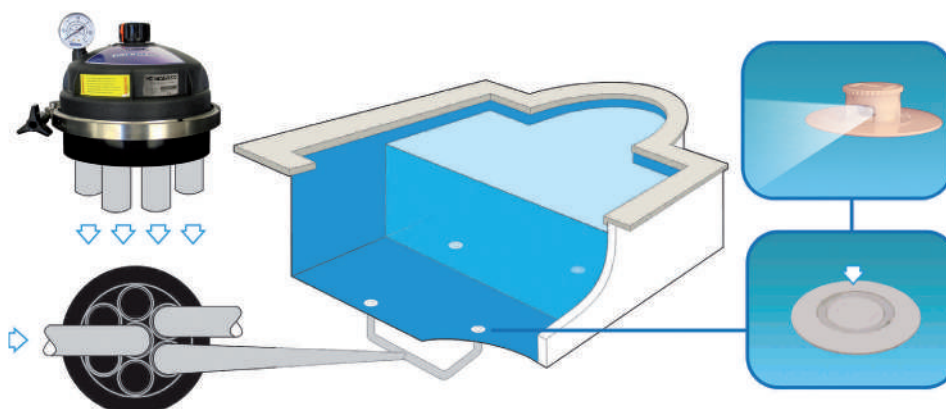

CLEANING



Net'n'Clean distributor valve Ø 50 mm



DESCRIPTION

Six way distribution valve. This valve is part of the Net'n'Clean cleaning system which is integrated in the pool floor. It distributes water sequentially through its various branches. Made of plastic and AISI 316L it has high resistance to salt water. Maximum working pressure: 1.4 bars. Maximum flow: 15 m³/h. Connections: 7 x Ø 50 mm. 2 pop-up nozzles for branch recommended.

	Code	Standard Pack	Standard weight in kg	Standard volume in m ³
Net'n'Clean distributor valve: European model	21257	1	1.7	0.015



Net'N'Clean distributor valve Ø 63 mm



DESCRIPTION

Distributor valve optimized for greater hydraulic performance. Maximum working pressure of 1.5 bars. Maximum flow of 25 m³/h. Connections: 7 x Ø 63 mm or 7 x Ø 75 mm. From 2 to 5 nozzles per branch.

	Code	Standard Pack	Standard weight in kg	Standard volume in m ³
Net'N'Clean distributor valve Ø 63 mm	35079	1	5.6	0.031

NET'N'CLEAR INTEGRATED CLEANING SYSTEM

Net'N'Clean reducing wall conduit for nozzles

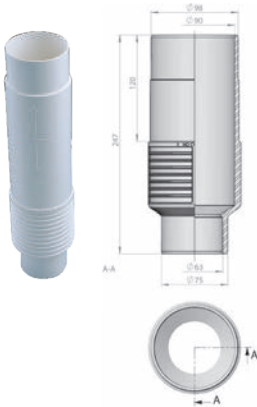

DESCRIPTION

Reducing conduit to install concrete Net'N'Clean nozzles (26985). Made in white PVC. Ø 50 mm inside & Ø 63 mm outside connections.

	Code	Standard Pack	Standard weight in kg	Standard volume in m ³
Reducing wall conduit for nozzles	21248	12	7.3	0.032

Ø 90 mm wall conduit



DESCRIPTION

PVC wall conduit. Cutting area of 120 mm for fitting it to the pool wall or floor. Ø 63 or Ø 75 connection, as required.

	Code	Standard Pack	Standard weight in kg	Standard volume in m ³
Ø 90/Ø 63-Ø 75 mm wall conduit	43590	9	7.3	0.033

For inlets:

Net'N'Clean: 43584

BCN 03: 43586 - 43587 - 43588 - 43589

Return inlet/suction nozzle for high flow rates: 41518 - 41519 - 41520 - 41521

Net'N'Clean nozzles



DESCRIPTION

Range of Net'N'Clean nozzles with four different outlets. S4 is recommended for pool floor and S1 or S2 for steps. Designed for concrete pools with glass tiling, liner pools and polyester pools. For in-ground pools, both adjustable and fixed nozzles are available, and for liner pools there are self-tapping nozzles or nozzles with metal inserts.

	Code	Standard Pack	Standard weight in kg	Standard volume in m ³
Nozzles				
For concrete pools:				
With swivel joint	26985	12	4.14	0.02
Fixed	26986	12	3.78	0.02
For polyester pools:				
Fixed	21209	12	4.14	0.02
For liner pools:				
Fixed, with PN10 metal insert	28500	12	5.05	0.034
Adjustable, with INSERTS	43584	12	5.64	0.033
Bodies				
For concrete pools:				
With swivel joint	65230	12	4.44	0.02
Fixed	65231	12	4.44	0.02
For polyester pools:				
Fixed	65232	12	4.44	0.02

Inner assembly kit



DESCRIPTION

Colours can be selected with the minimum number of parts. Existing pools can be renewed without any effort.

	Code	Standard Pack	Standard weight in kg	Standard volume in m ³
Inner assembly kit				
White	65234	12	4.4	0.031
Beige	65234CL090	12	4.4	0.031
Light grey	65234CL129	12	4.4	0.031
Anthracite grey	65234CL144	12	4.4	0.031

Polyester

Concrete

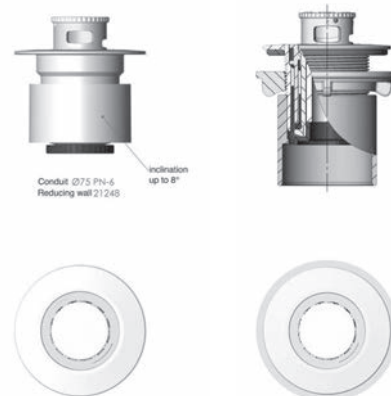

HOSES

Hose connectors



	Code	Standard Pack	Standard weight in kg	Standard volume in m ³
Ø 38 mm for connections to inlets 16328, 16329, 16330, 21644, 21645, in white ABS	05684	12	1.0	0.003
Ø 50 mm connections to inlets 00315, grey PP	01392	12	1.0	0.006

Hose fitting



DESCRIPTION

White ABS plastic.

	Code	Standard Pack	Standard weight in kg	Standard volume in m ³
For Ø 38 mm hose, male thread 1½"	01393	12	1.0	0.006

HOSES

Hose cuffs



	Code	Standard Pack	Standard weight in kg	Standard volume in m ³
Made in flexible blue PVC				
For Ø 38 mm (01372) hose Only for vac inlets 24415	07958	12	2.0	0.003
For Ø 38 mm hose (01372)	01385	12	2.0	0.003
For Ø 50 mm hose (01373)	01386	12	3.0	0.010
Made in flexible white PVC				
For Ø 38 mm hose (01374-01375 01376-01377-01378)	01387	12	2.0	0.030
For Ø 50 mm hose (01379)	01388	12	3.0	0.010



Floating suction hose



DESCRIPTION

Transparent blue Polyethylene hose.

	Code	Standard Pack	Standard weight in kg	Standard volume in m ³
Ø 38 mm (1½")	01372	30 m	8.0	0.108
Ø 50 mm (2")	01373	30 m	14.0	0.192



Floating suction hose



DESCRIPTION

Made of blue polyethylene. Includes terminals, except in the 30-m hose (01374, 01379).

	Code	Standard Pack	Standard weight in kg	Standard volume in m ³
Ø 38 mm (1½")				
30 m	01374	1	12.0	0.192
15 m	01375	1	5.6	0.192
12 m	01376	1	4.5	0.192
10 m	01377	1	3.0	0.192
8 m	01378	1	3.0	0.192
Ø 50 mm (2")				
30 m	01379	1	15.0	0.240



Hose roller



DESCRIPTION

For hoses of up to 15 metres.

	Code	Standard Pack	Standard weight in kg	Standard volume in m ³
Hose roller	66042	1	2.4	0.05



POOL LIGHTING



308 LIGHTS NEW LEGISLATIONS

310 LED LIGHTING - LUMIPLUS

- 310 LEDs selection guide
- 312 LED LumiPlus Flexi
- 317 LED LumiPlus Flexi Mini
- 318 LED LumiPlus Design
- 319 LED LumiPlus Lamps PAR 56
- 320 LED LumiPlus Mini V3
- 321 LED LumiPlus Mini V2
- 322 LED LumiPlus Micro
- 324 LED lighting – Control systems
- 328 Aquasphere – Other LED lights

329 HALOGEN LAMPS AND HALOGEN LIGHTING

331 NICHES

333 TRANSFORMERS AND ACCESSORIES

336 AQUARMONY UNDERWATER MUSIC SYSTEM

New EU regulation*

from 1st September 2021

According to the eco-design regulation, the swimming pool halogen lights can no longer be sold in the European Union market



POOL LIGHTING



We are your LED's best partner

With our LED solutions for swimming pools, we'll make it easy for you and your customers



MADE IN EUROPE

100% production in our own facilities



QUALITY CONTROL

360° continuous control from suppliers ISO certifications to finished products



BUILT BY POOL EXPERTS

More than 15 years of R&D experience to design, inject and test watertight solutions

*EU Regulation 2019/2020 (Ecodesign requirements for light sources), halogen lights for swimming pools can no longer be sold in the EU countries. This also applies to the United Kingdom and Qatar.

Energy efficiency

New European regulation of energy labeling for lamps and projectors



POOL LIGHTING

NEW ENERGY EFFICIENCY LABEL FOR LIGHTING

The European Union launches the European Regulation EU 2019/2015 on new energy efficiency labeling in lamps and projectors that starts on September 1st, 2021 and repeals the European Regulation EU 874/2012.

The new Energy Efficiency label allows:

- Providing more information to the installer and customer. Thanks to the new QR code will access the European EPREL base, where the characteristics of the product are available.
- Carrying out a new energy classification promotes evolution of lighting technology.
- Greater control of products manufactured in the EU, with the QR code.

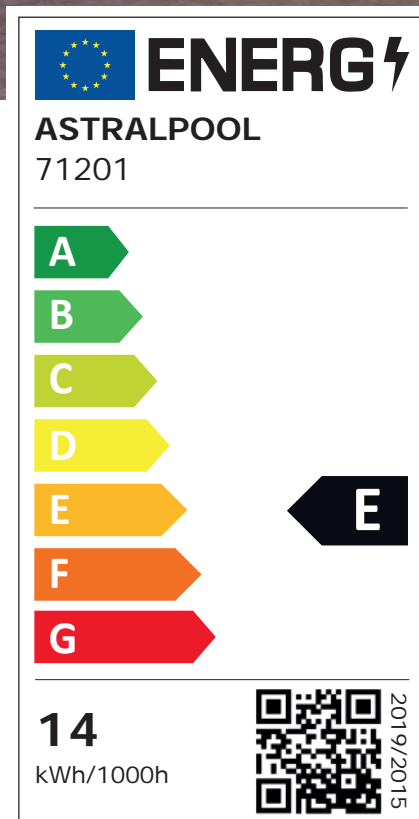

New label

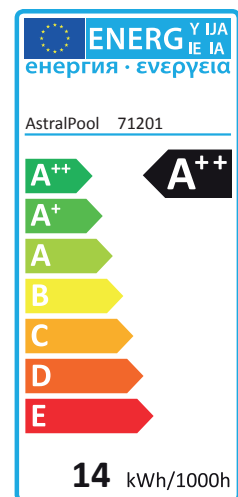















































Old label

The new classification must be marked on the unit packagings with the label, and in catalogs and product data sheets with the symbol below.



LEDs selection guide



		Projectors							Lamps				
		Commercial pools		Residential pools			Stairs	SPAS	Commercial pools	Residential pools			
		LumiPlus Design	LumiPlus Flexi V2	LumiPlus Flexi V1	PAR56 & Flat	LumiPlus FlexiMini V2	LumiPlus FlexiMini V1	LumiPlus Micro	LumiPlus PAR56 V2	LumiPlus PAR56 V1 (2)	Lamps PAR56 (2)		
Brand		ASTRALPOOL 		ASTRALPOOL 			ASIA SPHERE 	ASTRALPOOL 	ASTRALPOOL 	ASTRALPOOL 	ASTRALPOOL 	ASTRALPOOL 	ASIA SPHERE 
Lifespan (h)		L70 50000h	L70 50000h	L70 50000h	L70 25000h	L70 50000h	L70 50000h	L70 50000h	L70 50000h	L70 50000h	L70 50000h	L70 25000h	
Warranty (years)		3	3	3	2	3	3	2	3	3	3	2	
Decorative ring		Stainless Steel effect White	Stainless Steel White Anthracite Light grey Beige			White	Stainless Steel White Anthracite Light grey Beige		Stainless Steel White	-	-	-	
Type of installation		Niche Ø180 mm	Niche Ø180 mm up to 230 mm (PAR56) Surface mounted Inlet or nozzle			Niche Ø230 mm (PAR56) Surface mounted	Mini niche Nozzles Pipes		Ø50 mm pipe 1"1/4 thread	PAR56 Projector			
RGB	Watts	AC	32	43	22	15	7.6	3.8	4	48	22	15	
	Lumens		2544	2544	1100	900	600	300	186	2544	1100	900	
	Efficiency												
Control options	Control	LumiPlus Top LumiPlus App LumiPlus DMX		LumiPlus ECO LumiPlus Top LumiPlus App		Wireless Control Motion	RC	(a) LumiPlus Top LumiPlus App LumiPlus DMX	(a) LumiPlus Eco LumiPlus Top LumiPlus App	LumiPlus Top LumiPlus App LumiPlus DMX	LumiPlus Top LumiPlus App LumiPlus DMX	(a) LumiPlus ECO LumiPlus Top LumiPlus App	RC
													
White	Watts	DC High efficiency			8.7								
		DC		32	14		6.8	3		32	14		
		AC	45	32	14.5	11.5	7.2	3.5	4		14.5	11.5	
	Lumens		4320	4320	1485	1300	900	450	315	4320	1485	1300	
	Efficiency	DC ⁽¹⁾ High efficiency											
DC ⁽¹⁾													
AC													

* Compatible with ABS niches.

(1) DC - power supply included.

(2) AC lamp direct retrofit with 300 W halogen lamps.



AstralPool LumiPlus is the most extensive family in the market of underwater spotlights for public, commercial and residential pools.

The entire LumiPlus range is made of high-quality LEDs and electronic components, and is manufactured entirely in the EU to European quality standards.

The AstralPool LumiPlus family delivers:

- Greater energy efficiency.
- High performance projectors with top quality lighting (TQL) technology.
- Enhanced energy efficiency in pools thanks to the use of LumiPlus DC lamps and projectors run from a direct current power source (24 V DC).
- Great control over the range with the inclusion of the Internet of Pools (IoP) concept by Fluidra Connect.
- IP68 protection rating.
- L70 50000 hours lifespan.

The most comprehensive range for every type of pool

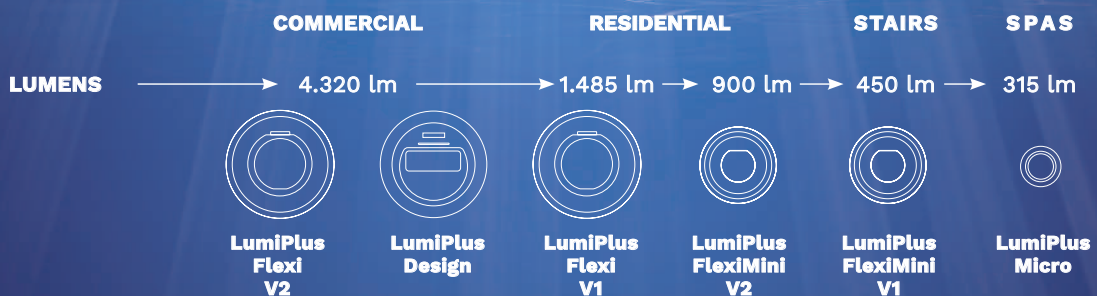

NEW
2022

PROJECTOR

LumiPlus Flexi

The LED solution that adapts to every type of pool

NEW
2022

High efficiency Flexi lamp

The most efficient solution 170 lm/W



The LumiPlus projectors, FlexiNiche, FlexiSlim and FlexiRapid, are characterised by their more stylish finish and their great adaptability to any type of new-build or existing pool, whether a liner or concrete pool, that can be fitted to niches on the surface or in bushings.

“AstralPool’s LumiPlus Flexi system delivers top flexibility”



WHITE ANTHRACITE GREY BEIGE LIGHT GREY STAINLESS STEEL



PROJECTOR

LumiPlus Flexi

The LED solution that adapts to all types of pool



The family of LumiPlus Flexi spotlights – FlexiNiche, FlexiSlim and FlexiRapid – is characterized by its great adaptability to any type of new-build or existing pool, whether a liner or concrete pool, that can be fitted to niches, on the surface or in bushings. The LumiPlus Flexi system delivers top flexibility.

Versions V1 and V2 are ideal for residential pools and public/hotel pools, respectively.

LumiPlus Flexi is the perfect solution for your pool that lets you choose:

1. The color of the light.
2. The mounting system.

3. The faceplate color that best matches your pool, between white, beige, Light grey, anthracite grey and stainless steel, this one only for the FlexiNiche version.

The FlexiNiche version with his unique system of screws can adapt to any niche from diameter 180 up to 230 mm.

FlexiSlim version is compatible with the brackets for Flat, Extraflat and Slim Projectors by AstralPool.

FlexiRapid is compatible with any bushing with 1 1/2" internal thread.



Dimensions

LumiPlus FlexiNiche		LumiPlus FlexiSlim	LumiPlus FlexiRapid
Niche Ø 180-230 mm		Walls	Inlets
ABS	Full stainless steel		

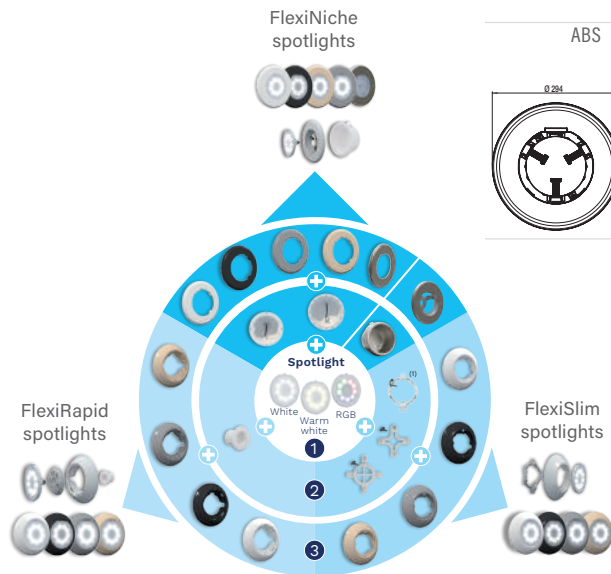

Dimensions

Spotlight LumiPlus Flexi

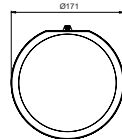

How to install them?

LumiPlus FlexiNiche



LumiPlus FlexiSlim



LumiPlus FlexiRapid



Point of light features

	Color of lamp	Watts	Color temperature	Control system	Efficiency
Residential V1 WHITE : 1485 lm / RGB : 1100 lm AC - 12V AC / DC - 24V DC	White AC	14.5 W (20VA)	5 700K	ON / OFF	E
	Warm White AC	14.5 W (20VA)	3 000K	ON / OFF	E
	White DC	14 W	5 700K	ON / OFF	E
	Warm White DC	14 W	3 000K	ON / OFF	E
	White DC high efficiency	8.7 W	5 700K	ON / OFF	B
	RGB AC	22 W (29 VA)	-	LumiPlus ECO / LumiPlus Top / Fluidra Connect / WIFI LED App	G
	RGB WIR AC	22 W (29 VA)	-	Wireless Control Motion	G
Public/Hotel V2 WHITE : 4320 lm / RGB : 2544 lm AC - 12V AC / DC - 24V DC	White AC	32W (42VA)	5 700K	ON / OFF	D
	Warm White AC	32W (42VA)	3 000K	ON / OFF	D
	White DC	32 W	5 700K	ON / OFF	D
	Warm White DC	32 W	3 000K	ON / OFF	D
	RGB AC	43W (54VA)	-	LumiPlus ECO / LumiPlus Top / Fluidra Connect / WIFI LED App	G
	DMX RGB AC	43W (54VA)	-	LumiPlus RGB DMX	G

*Sea water-proof. ABS versions.
AC - Alternating current. DC - Direct current. DC versions are delivered with power pack.



The models with RGB light are compatible with Fluidra Connect.

LumiPlus Flexi projectors

Components required to install a LumiPlus Flexi



Choose amongst the components according to your requirements:

- New-build pools - FlexiNiche or FlexiRapid: 1+2+3
- New-build pools - FlexiSlim: 1+3
- Replacement without changing niche: 1+3

LumiPlus Flexi is made up of 3 components

1 Spotlight 2 Niche 3 Decorative ring

The 3 components are required for the proper installation of FlexiNiche and FlexiRapid.

1 Spotlight		Code	Code
		V1	V2
	White AC LumiPlus Flexi spotlight	71200	71233
	Warm White AC LumiPlus Flexi spotlight	71200WW	71233WW
	White DC LumiPlus Flexi spotlight	71201	71202
	White DC LumiPlus Flexi spotlight High Efficiency	71236	
	Warm White DC LumiPlus Flexi spotlight	71201WW	71202WW
	RGB AC LumiPlus Flexi spotlight ⁽¹⁾	71203	71204
	Wireless AC LumiPlus Flexi spotlight ⁽²⁾	71205	
	Wireless AC 1 PL LumiPlus Flexi spotlight + 1 Control Motion ⁽²⁾	71206	
	Wireless AC 2 PL LumiPlus Flexi spotlight + 1 Control Motion ⁽²⁾	71207	
	RGB DMX AC LumiPlus Flexi spotlight ⁽¹⁾		71208

All spotlights come with a 2.5 m power cable. Power cables of 5 m, 10 m and 15 m available on request.

(1) Choose the most suitable control system (see control systems section).

(2) Compatible with ABS trim solutions.

2 Installation		Code	Code
		Niche Ø180	Niche Ø230
	Niches (*)		
	Niche in ABS for concrete pools	59813	00349
	Niche S.S. for concrete pools /prefabricated pools		54102 / 54103
	Niche in ABS for prefabricated pools with inserts	59814	00364 / 17805
	Niche in ABS for prefabricated pools without inserts	59815	28887 / 72261
	Niche in ABS for panel pools with inserts / without inserts		23671 / 23670
	Inlet		
	Inlet for concrete pools with 1 1/2" threaded Ø63 PN-6 piping		35418
	Inlet for concrete pools with 1 1/2" threaded Ø63 PN-10 piping		35421
	Inlet for liner prefabricated pools with 1 1/2" thread		27084
	Inlet for polyester prefabricated pools		38805

Other Ø230 and Ø180 niches also available (see catalogue).

For FlexiSlim version installed in concrete + liner pools, Kit 71234 should be used to complete installation (not delivered with).

* Suitable to use ABS niches with Flexi ABS decorative ring.

3 Decorative ring with fitting		Code
	FLEXINICHE	
	White	71209
	Beige	71209CL090
	Light Grey	71209CL129
	Anthracite grey	71209CL144
	Stainless steel AISI 316-L embellisher with ABS body	71209CLSS
	Full Stainless Steel AISI 316-L	73440
	FLEXISLIM	
	White	71210
	Beige	71210CL090
	Light Grey	71210CL129
	Anthracite grey	71210CL144
	FLEXIRAPID	
	White	71211
	Beige	71211CL090
	Light Grey	71211CL129
	Anthracite grey	71211CL144

KITS : DECORATIVE RING + SPOTLIGHT		Code	Code
		White AC	White DC
	FlexiNiche: White decorative ring + white spotlight	71212	71213
	FlexiSlim: White decorative ring + white spotlight	71214	71215
	FlexiRapid: White decorative ring + white spotlight	71216	71217
	FlexiNiche : Full SS Projector body + white spotlight	73442	73441

AC - Alternating current DC - Direct current



LUMIPLUS FLEXIMINI COMPACT DESIGN. MAXI-CUSTOMIZATION.



POOL
LIGHTING



THE PERFECT SIZE FOR A BETTER DESIGN.

LumiPlus FlexiMini is a compact LED solution in line with current design trends for residential pools. It combines perfectly with LumiPlus Flexi range.



SIMPLIFIED INSTALLATION.

LumiPlus FlexiMini provides one point of light common to all installation methods. Thanks to its simplified connection compatibility with each construction mode, LumiPlus FlexiMini enables easy installation and retrofit with most of the lightings on the market.

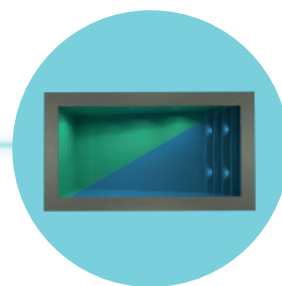

MAXI-CUSTOMIZATION FOR EVERYONE'S STYLE.

LumiPlus FlexiMini offers a customizable lighting installation with the desired lumens (2 levels for stairs and basin), with any connection mode (nozzles, tube, well conduits, niche) and 5 color options to create a unique lighting experience for the pool owner.

LumiPlus FlexiMini

Compact design. Maxi customization.



The LumiPlus Flexi Mini projector is an underwater projector with reduced dimensions that stands out for its ease and flexibility of installation, being compatible with the Mini V2 and V3 niches, 1 1/2" internal thread nozzles, 63mm or 2" cable glands, pipes D63 PN6 and PN10 or D50 PN10 pipes. Its configuration is carried out in three steps in new pools. You need to choose :

- 1.- The spotlight
- 2.- One of the 4 models of decorative ring: niche; nozzle L; nozzle S; or, for pipe or wall bushings.

The decorative ring can be made of ABS in a white, light gray, anthracite gray or beige finish; or AISI- 316L stainless steel.

- 3.- The niche, the nozzle or the wall bushing for the installation.

When renovating swimming pools, you should only choose sections 1 and 2.

The point of light is available in two powers, V1 for lighting stairs and V2 for lighting the basin, and you can choose between white, warm white and RGB multicolor light. The RGB versions are compatible with ECO, TOP, Wireless, LumiPlus LED App, ModBUS (Connect) and DMX controls (see page 324-325).



Dimensions

Spotlight FlexiMini

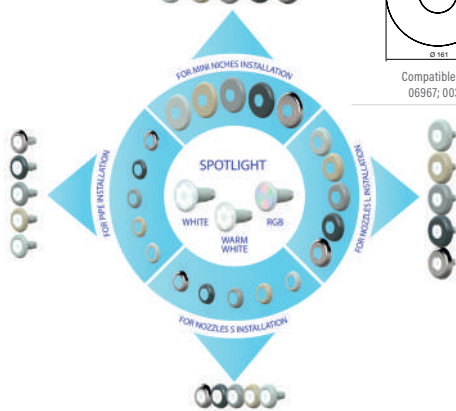
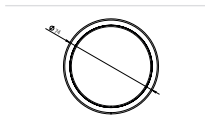

Dimensions

LumiPlus FlexiMini Niche	LumiPlus FlexiMini Nozzles L		LumiPlus FlexiMini Nozzles S		LumiPlus FlexiMini pipes / wall conduits
Niche	Nozzle L 2"	Nozzle L 1 1/2"	Nozzle S 2"	Nozzle S 1 1/2"	Pipe Ø50 PN6 / P10 Wall conduit 2" / 1 1/2"
Compatible with niches 06967; 00369; 49828	Compatible with nozzles Ømax. 116 mm and depth between 0 and 10 mm		Compatible with nozzles Ømax. 91 mm and depth between 7 and 9 mm		

How to install them?

LumiPlus FlexiMini Niche	LumiPlus FlexiMini Nozzles L	LumiPlus FlexiMini Nozzles S	LumiPlus FlexiMini Pipes / Wall conduits

Spotlight features

	Color of lamp	Watts	Color temperature	Control system	Efficiency
Pool stairs FlexiMini V1 WHITE : 450 lm/ RGB : 300 lm AC - 12V AC / DC - 24V DC	White AC	3.5 W	5 700K	ON / OFF	D
	White DC	3 W	5 700K	ON / OFF	C
	Warm White AC	3.5 W	3 000K	ON / OFF	D
	Warm White DC	3 W	3 000K	ON / OFF	C
	RGB	3.8 W	-	LumiPlus ECO / LumiPlus Top / Fluidra Connect / WIFI LED App	F
	RGB Wireless (WIR)	4.3 W	-	1) Wireless Control Motion	G
Residential pool basin and stairs FlexiMini V2 WHITE : 900 lm/ RGB : 600 lm AC - 12V AC / DC - 24V DC	White AC	7.2 W	5 700K	ON / OFF	D
	White DC	6.8 W	5 700K	ON / OFF	D
	Warm White AC	7.2 W	3 000K	ON / OFF	D
	Warm White DC	6.8 W	3 000K	ON / OFF	D
	RGB	7.6 W	-	LumiPlus ECO / LumiPlus Top / Fluidra Connect / WIFI LED App	F
	RGB Wireless (WIR)	8 W	-	1) Wireless Control Motion	F
	Kit 3 RGB Wireless V2 (with RC)	8 W	-	1) Wireless Control Motion	F
DMX	8 W	-	LumiPlus RGB DMX	F	

*Sea water-proof. ABS versions.
AC - Alternating current. DC - Direct current. DC versions are delivered with power pack.
1) Maximum installation depth 40cm.



The models with RGB are compatible with Fluidra Connect.

LumiPlus FlexiMini

Components to install a LumiPlus FlexiMini projector



The LumiPlus Flexi Mini is a solution that allows maximum flexibility in terms of colors of the lights, lumens color of the visible parts and as well of the installation method.

LumiPlus FlexiMini is a compact LED solution in line with current design trends for residential pools. It combines perfectly with LumiPlus Flexi range.

Choose amongst the components according to your requirements:

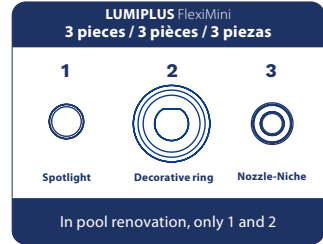

1 Spotlight



1.1 - LUMIPLUS FLEXIMINI V1 - IDEAL FOR STAIRS

	Code
White AC	74400
White DC	74401
Warm White AC	74400WW
Warm White DC	74401WW
RGB	74402
RGB Wireless (WIR)	74403



1.2 - LUMIPLUS FLEXIMINI V2 - IDEAL FOR RESIDENTIAL POOL

White AC	74406
White DC	74407
Warm White AC	74406WW
Warm White DC	74407WW
RGB	74408
RGB Wireless (WIR)	74404
Kit 3 RGB Wireless V2 + 1 Control Motion	74405
DMX	74409

Note: 2.5 m cable included

2 LumiPlus FlexiMini Decorative ring with fitting (Delivered with installation accessories)



2.1 - DECORATIVE RING FOR MINI NICHEs

Decorative ring for Mini Niche in ABS color White	74392
Decorative ring for Mini Niche in ABS color Beige	74392CL090
Decorative ring for Mini Niche in ABS color Light grey	74392CL129
Decorative ring for Mini Niche in ABS color Anthracite	74392CL144
Decorative ring for Mini Niche in Stainless Steel A316-L with ABS body	74392CLSS



2.2 - DECORATIVE RING FOR NOZZLES L (LARGE)

Decorative ring for nozzle L in ABS color White	74393
Decorative ring for nozzle L in ABS color Beige	74393CL090
Decorative ring for nozzle L in ABS color Light grey	74393CL129
Decorative ring for nozzle L in ABS color Anthracite	74393CL144
Decorative ring for nozzle L in Stainless Steel A316-L with ABS body	74393CLSS



2.3 - DECORATIVE RING FOR NOZZLES S (SMALL)

Decorative ring for nozzle S in ABS color White	74394
Decorative ring for nozzle S in ABS color Beige	74394CL090
Decorative ring for nozzle S in ABS color Light grey	74394CL129
Decorative ring for nozzle S in ABS color Anthracite	74394CL144
Decorative ring for nozzle S in Stainless Steel A316-L with ABS body	74394CLSS



2.4 - DECORATIVE RING FOR PIPE

Decorative ring for pipe in ABS color White	74395
Decorative ring for pipe in ABS color Beige	74395CL090
Decorative ring for pipe in ABS color Light grey	74395CL129
Decorative ring for pipe in ABS color Anthracite	74395CL144
Decorative ring for pipe in Stainless Steel A316-L with ABS body	74395CLSS

3 Installation supports per type of pool that combines with the decorative rings

Type of pool	Option	2.1 Faceplate for niches	2.2 - Faceplate for nozzles L	2.3 - Faceplate for nozzles S	2.4 - Faceplate for Pipe
Concrete	Recommended	06967	56498	35418	15661
	Other possibilities	-	00295, 00298, 56498, 00300, 00301	53956, 35421	00322, 00323
Concrete + liner	Recommended	00369	59983	00338	-
	Other possibilities	-	00332, 17382	27084	-
Panels	Recommended	00369	00330	27084	-
	Other possibilities	-	17383, 00332, 56498, 56499	06481, 32450, 33092, 33091, 06498	-
Polyester	Recommended	49828	00330	74179	-
	Other possibilities	-	00332, 00334, 00336	38805, 06481, 06484, 32450, 32451	-

Installation accessories can be found in Pool shell equipment chapter on within lights chapter, Niches subchapter.

Projector Design



DESCRIPTION

The LumiPlus Design projector is a high power underwater projector that can be installed in 180mm diameter niches.

The decorative ring is available in Stainless Steel effect and Pure White finishes.

The light can be white, warm white, and RGB multi-color. The RGB versions are compatible with ECO, TOP, Wireless, LumiPlus LED App, ModBUS (Connect) and DMX controls (see codes in page 325).

LumiPlus monocolour white light lamps and projectors are also available in Warm White.



TECHNICAL FEATURES

Light Colour		Projector Design		Consumption	Luminous flux	
		White 	Stainless steel effect 			
	White		59807	59805	32W (35VA)	4320 lm
	RGB 		59803	59801	32W (42VA)	2544 lm
	RGB DMX		59811	59809	32W (42VA)	2544 lm

Rated voltage: 12V AC. IPX8 protection. Includes 2.5 m H07RN-F 2x1.5 mm² cable.
Adaptor kit available for other niche types from diameter 180 to 190 mm. Code: 59818. It must always be installed underwater.

Niches for projector Design



TECHNICAL FEATURES

Niches			
Concrete pool	Prefabricated pools		Fixing kit for other niches
	With inserts	Without inserts	
59813 	59814	59815	59818*

Compatible with: LumiPlus FlexiNiche ABS and Stainless Steel and LumiPlus Design.
*Compatible with the majority of niches from Ø180 to Ø190 mm on the market (Hugo Lahme, MTS Productksts, Wibre...).



Fluidra Connect-compatible



Seawater-proof

LED LIGHTING - LUMIPLUS

LumiPlus lamps for PAR56 V2 projectors



DC PAR56 V2 lamp



How to replace a PAR 56 lamp?



DESCRIPTION





The RGB model is compatible with LumiPlus ECO, LumiPlus Top, LumiPlus LED APP and LumiPlus Modbus controls. The RGB DMX model requires the LumiPlus DMX 41107 modulator.

To correctly light a pool it is advisable to install a light from the LumiPlus V1 range every 20m² of water surface. This recommendation applies to pools light in colour with white light spotlights, but if there are RGB spotlights more should be fitted. In dark or stainless steel pools it is recommended to use more projectors per m².

TECHNICAL FEATURES

DC PAR56 V2 lamp			
Light Colour	Code	Consumption	Luminous flux
 White Warm white	 67516 	32W	4320 lm
	67516WW 		

Rated voltage: 24 V DC. Protection rating: IPX8. Includes 220V AC - 24 V DC power pack. Does not work with 220 V AC-12 V AC electromagnetic transformers. It must always be installed underwater.

PAR56 V2 lamp			
Light Colour	Code	Consumption	Luminous flux
 RGB  RGB DMX	 43411 	48W (64VA)	2544 lm
	45637 	48W (64VA)	2544 lm

Rated voltage: 24 V DC. Protection rating: IPX8. It must always be installed underwater.

LumiPlus lamps for PAR56 V1 projectors



DC PAR56 V1 lamp



How to replace a PAR 56 lamp?







DESCRIPTION







The RGB model is compatible with LumiPlus ECO, LumiPlus Top, LumiPlus LED APP and LumiPlus Modbus controls. The RGB DMX model requires the LumiPlus DMX 41107 modulator.

To correctly light a pool it is advisable to install a light from the LumiPlus V1 range every 20m² of water surface. This recommendation applies to pools light in colour with white light spotlights, but if there are RGB spotlights more should be fitted. In dark or stainless steel pools it is recommended to use more projectors per m².

TECHNICAL FEATURES

DC PAR56 V1 lamp			
Light Colour	Code	Consumption	Luminous flux
 White Warm white	 67515 	14W	1485 lm
	67515WW 		

Rated voltage: 24V DC. Protection rating: IPX8. Includes 220V AC - 24 V DC power pack. Does not work with 220 V AC-12 V AC electromagnetic transformers. It must always be installed underwater.

PAR56 V1 lamp			
Light Colour	Code	Consumption	Luminous flux
 White Warm white	 52596 	14.5W (20VA)	1485 lm
	52596WW 		
RGB 	 56001 	22W (29VA)	1100 lm

Rated Voltage: 12V AC. Protection: IPX8. It must always be installed underwater.

Wireless PAR56 V1 lamp

	1 lamp + 1 Control Motion	2 lamps + 1 Control Motion	1 lamp RGB 1.11 Wireless	Consumption per lamp	Luminous flux per lamp
  	59126 	59127 	59124 	22W (29VA)	1100 lm

Rated voltage: 12V AC. Protection rating: IPX8. It must always be installed underwater. The LumiPlus Control Motion is not waterproof.  Seawater-proof

LumiPlus MINI V3 projectors



DESCRIPTION

The LumiPlus Mini V3 projector is a compact underwater projector made entirely of high-quality plastic. Available in white, warm white, and multi-color RGB light. The RGB versions are compatible with ECO, TOP, LumiPlus LED App, ModBUS (Connect) and DMX controls (see page 324-325). You can choose between two types of decorative ring: pure white and stainless steel effect. There are three versions of this projector: concrete pool, prefabricated pool and SPA. LumiPlus monocolour white light lamps and projectors are also available in Warm White.

TECHNICAL FEATURES

MINI V3 projector

Light Colour		Decorative ring	Concrete	Prefabricated/Liner	SPAS	Consumption	Luminous flux
White	F	White	59979	69637	59981	4W (6VA)	315 lm
		Stainless steel effect	59980	69638	59982		
RGB	G	White	59971	69633	59973	4W (7VA)	186 lm
		Stainless steel effect	59972	69634	59974		
RGB DMX	G	White	59975	69635	59977	4 W (4 VA)	186 lm
		Stainless steel effect	59976	69636	59978		

Rated Voltage: 12V AC (RGB & White) 24V DC (RGB-DMX). IPX8 protection. 2.5 m H07RN-F 2 x 1 mm² cable. It must always be installed underwater.



Niches, nozzles and fittings

for LumiPlus MINI V3

TECHNICAL FEATURES

Niches for LumiPlus MINI V3

Description	Bushing / Tube ø63 PN-6 / PN-10	Concrete pools			Prefabricated pools		
		1½ threaded inlet Ø 63 PN-6 piping	1½ threaded inlet Ø 63 PN-10 piping	Nozzle with niche	Liner	Fibreglass	
Code	62395	35418	35421	53956	27084	59983	38805



Fluidra Connect-compatible



Seawater-proof



Until end of stock

LumiPlus MINI V2 projectors



Snap-in MINI V2 projectors



DESCRIPTION











To correctly light a pool it is advisable to install a projector from the LumiPlus Mini V2 range every 5 m² of water surface. NB: recommendations valid for light coloured pools and white light projectors; oversize in RGB colours. In darker coloured pools or stainless steel pools, we recommend oversizing the proportion of projectors per m².

Projectors may be installed both in and out of the water. Niche according to model; not included and needed to finish the installation. The RGB model is compatible with LumiPlus ECO, LumiPlus Top, LumiPlus LED APP and LumiPlus Modbus controls. The RGB DMX model requires the LumiPlus DMX 52142 controller (see page 324-325).

LumiPlus monocolour white light lamps and projectors are also available in Warm White.





TECHNICAL FEATURES

Snap-in MINI V2 projector

Light Colour		Type of decorative ring		Consumption	Luminous flux
		White	S.S.		
White		52130 	52131 	4W (6VA)	315 lm
RGB 		52124 	52125 	4W (7VA)	186 lm
RGB DMX		52136 	52137 	4W (4VA)	186 lm











Rated Voltage: 12V AC (RGB & White) 24V DC (RGB-DMX). IPX8 protection. Includes 2.5 m H07RN-F 2x1.5 mm² cable. Compatible with a Ø63 bushing (code 15661) or snap-in mini niche from concrete pool code 53956 (not included).

MINI V2 projector for SPA

Light Colour		Type of decorative ring		Consumption	Luminous flux
		White	S.S.		
White		52132	52133	4W (6VA)	315 lm
RGB 		52126	52127	4W (7VA)	186 lm
RGB DMX		52138	52139	4W (4VA)	186 lm

Rated Voltage: 12V AC (RGB & White) 24V DC (RGB-DMX). IPX8 protection. Includes 2.5 m H07RN-F 2x1.5 mm² cable. Fastened between a threaded bolt and 2" nut.

MINI V2 projector for Mini Niche (light point)

Light Colour		Type of decorative ring		Consumption	Luminous flux
		White	S.S.		
White		52134 	52135 	4W (6VA)	315 lm
RGB 		52128 	52129 	4W (7VA)	186 lm
RGB DMX		52140 	52141 	4W (4VA)	186 lm

Rated Voltage: 12V AC (RGB & White) 24V DC (RGB-DMX). IPX8 protection. Includes 2.5 m H07RN-F 2x1.5 mm² cable. To complete the projector select the right niche for each swimming pool type (see page 331).

Color front plates for MINI V2 projectors

	Beige	Light grey	Anthracite
 Color front plate for Snap-in MINI V2 projector and MINI V2 projector for SPA and prefabricated pool	08554-0500CL090	08554-0500CL129	08554-0500CL144
 Color front plate for MINI V2 projector for Mini Niche (light point)	04582-0500CL090	04582-0500CL129	04582-0500CL144



Fluidra Connect-compatible



Untill end of stock

LumiPlus MICRO projectors



Snap-in MICRO projectors



DESCRIPTION





To correctly light a pool it is advisable to install a projector from the LumiPlus Micro range every 5 m² of water surface. NB: recommendations valid for light coloured pools and white light projectors; oversize in RGB colours. In darker coloured pools or stainless steel pools, we recommend oversizing the proportion of projectors per m².

LumiPlus monocolour white light lamps and projectors are also available in Warm White.

Projectors may be installed both in and out of the water. Niche according to model; not included and needed to finish the installation. The RGB model is compatible with LumiPlus ECO, LumiPlus Top, LumiPlus LED APP and LumiPlus Modbus controls. The RGB DMX model requires the LumiPlus DMX 52142 feed controller (see page 324-325).





TECHNICAL FEATURES

Snap-in MICRO projector

Light Colour	Type of decorative ring		Consumption	Luminous flux		
	White	S.S.				
	White		38814	38816	4W (6VA)	315 lm
	RGB 		64552	64553	4W (7VA)	186 lm
	RGB DMX		64557	64558	4W (4VA)	186 lm

Rated Voltage: 12V AC (RGB & White) 24V DC (RGB-DMX). IPX8 protection. Includes 2.5 m H07RN-F 2x1.5 mm² cable.

MICRO projector for SPA

Light Colour	Type of decorative ring		Consumption	Luminous flux		
	White	S.S.				
	White		40765	40766	4W (6VA)	315 lm
	RGB 		64554	64555	4W (7VA)	186 lm
	RGB DMX		64559	64560	4W (4VA)	186 lm

Rated Voltage: 12V AC (RGB & White) 24V DC (RGB-DMX). IPX8 protection. Includes 2.5 m H07RN-F 2x1.5 mm² cable. Fastened between a threaded bolt and 2" nut.

Outdoor lighting

Starlight portable lights













DESCRIPTION

Decorative lights for indoors and out and even for floating in the water. Includes a remote control for choosing one of the 16 different colours available. They work on low consumption LED technology and once the battery has been charged have a runtime of up to 20 hours. Starlight is water-resistant The charger is supplied with the product.

	Code	Standard Pack	Standard weight in kg	Standard volume in m ³
StarLight Altair Conical shape 290 x 320 mm	53937	1	3	0.050
StarLight Sirio Circle shape Ø 350 mm	53938	1	3	0.051
StarLight Vega Oval shape 350 x 270 mm	53939	1	3	0.051



Control systems

	System		Code	Description	Projectors
LumiPlus RGB ECO			32458	<p>The simplest and most economical colour change system.</p> <p>LumiPlus ECO is a push-button switch that allows 14 modes of operation: 7 fixed colours and 7 different colour sequences. Each time the push button is pressed, the colour or sequence will change. By pressing for several seconds, the light is white.</p> <p>The push button must be sized to withstand the power consumed by the number of lights in the facility. Maximum charge 700 VA. Must be connected in the transformer primary.</p>	Any LumiPlus RGB projector.
LumiPlus WIRELESS	LumiPlus Control Motion		59125	<p>Colour change CONTROL in your hand.</p> <p>The LumiPlus Control Motion remote control enables wireless projector control, directly offering on/off options, 12 colour changes, 8 sequence changes and sequence speed. It also detects movement, letting you activate colours and sequences by vertical and horizontal movements, respectively.</p> <p>Compatible with the LumiPlus Wireless range of projectors only. Can control 2 wireless projectors and 3 in FlexiMini</p>	Flexi (ABS body) V1 RGB Wireless PAR56 V1 RGB Wireless * Not compatible with stainless steel FlexiNiche projectors.
	LumiPlus Wireless Range Extender		64633	<p>Allows expansion of the signal that the LumiPlus Control Motion sends to the projectors with the wireless control system.</p> <p>Ideal for facilities whose architectural features or projectors installation makes it hard for the LumiPlus Control Motion signal to reach the wireless projectors properly.</p>	
LumiPlus RGB TOP			27818 + 41988	<p>The LumiPlus TOP system is a professional control of the color.</p> <p>System comprising the 27818 modulator and 41988 remote control that enables to control a large number of projectors. The modulator has an antenna with a 50m range to receive the signal from the remote control (bought separately).</p> <p>The LumiPlus TOP system enables:</p> <ul style="list-style-type: none"> Projector on/off action. Colour selection: 12 fixed colours available. Sequence selection: 8 sequences available. Sequence speed selection: 8 speeds available for each sequence. <p>Supplied separately. A total of 10 LumiPlus modulators can be synchronized.</p>	Any LumiPlus RGB projector.
LumiPlus LED APP LumiPlus WIFI	Existing installation		59131	<p>Control your pool lighting from your smartphone.</p> <p>App to check LumiPlus lights and projectors from an Android or iOS smartphone or tablet.</p> <p>Enables to control your LumiPlus lights or spotlights from your smartphone or tablet.</p>	Any LumiPlus RGB projector
	New installation		59132	<p>The LumiPlus app should only be installed as an additional feature to the LumiPlus Modulator. It offers a range of 12 colours and 8 sequences or colour change programs.</p> <p>Free app you can download directly from the following sites:</p> <p>Apple: www.lumiplusled-ios.astralpool.com Android: www.lumiplusled-android.astralpool.com</p> <div style="display: flex; justify-content: space-around; align-items: center;">      </div> <div style="display: flex; justify-content: space-around; align-items: center; margin-top: 5px;">   </div>	

Control systems

	System		Code	Description	Projectors
LumiPlus Modbus FLUIDRA CONNECT 				Control your pool lighting anywhere, anytime.	
	Existing installation		57434	<p>The Modbus protocol enables the control of the LumiPlus modulator. It can be used to switch the projectors on and off, change their colours and sequence speed and set the time for putting the projectors in sleep mode.</p> <p>Download the Fluidra Connect app for instant information about the state of your pool 365 days a year. Fluidra Direct is peace of mind, comfort and leisure. In addition to controlling projectors, LumiPlus lets you control the filtration, water treatment and more of your pool through the Modbus protocol.</p> <p>The LumiPlus Modbus should only be installed as an additional feature to the LumiPlus 27818 modulator for correct installation and operation.</p>	Any LumiPlus RGB projector
New installation		57435			
LumiPlus RGB DMX	RGB DMX Modulator		41107	<p>DMX LED projector modulator/12V AC</p> <p>DMX receiver for the Flexi, PAR56, S-LIM and Design ranges.</p> <p>Receiving orders from the DMX controller (Astral DMX 74099 or Astral DMX Pro 74500) via the DMX bus and acting on the projectors that are connected.</p>	LumiPlus RGB-DMX projector
	RGB-DMX power pack		52142	<p>Product designed exclusively for use with V2 and V3 Mini LED and RGB DMX Micro projectors.</p> <p>The power pack can control up to 9 projectors, receiving orders from the system's DMX controller (Astral DMX 74099 or Astral DMX Pro 74500) via the DMX bus and acting on the projectors that are connected.</p> <p>The power pack has been designed to be used solely with DMX protocol and 24V DC DMX controllable parts from AstralPool.</p>	
	DMX controller		74099	<p>LumiPlus DMX System makes it possible to control lights individually or by groups.</p> <p>Users will have easy and intuitive full control over a projector or group of projectors.</p> <p>Main advantages / benefits:</p> <ul style="list-style-type: none"> Very accurate control over the lights: colour and dimming. Plug and play. Projectors can be operated independently or combined. Allows creating new light scenes. 	
	DMX PRO controller		74100	<p>LumiPlus DMX system does not require any additional wiring for projectors.</p> <p>Smartphone or tablet control via an app.</p>	

Did you know?

According to EN 2012/19/UE,
broken halogen lamps should be disposed in special recycling centers.

We do it for YOU



Fluidra is committed to the environment by using sustainable products and practices to protect future generations.

Did you know?

LED lamps power consumption is 30x lower than Halogen lamps* and **LEDs lifespan is 10x** more than Halogen lamps.

DO like 70% of pool builders
& CONTRIBUTE to the environment

Example of consumption in kW

1 pool with 2 projectors.
 Usage : 4 months / 4 hours per day.
 Price of kWh : 0.18 €.

Consumption per season

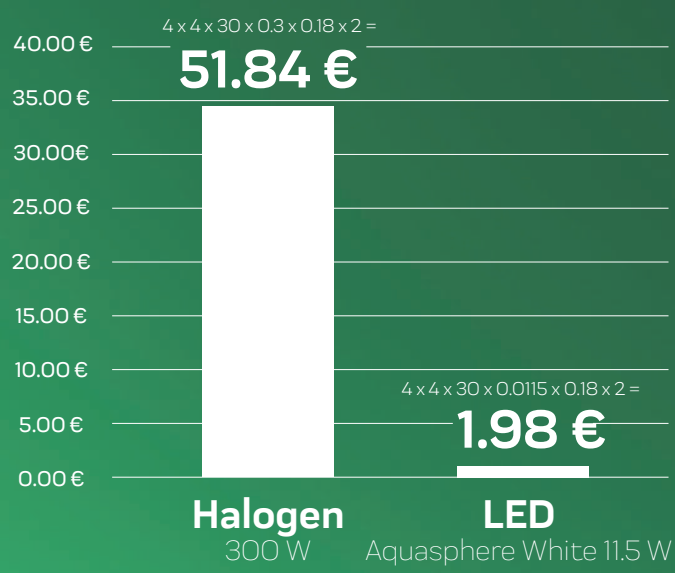

Power cost difference per season pays the price difference between halogen and LED lamps.

*Note : example taken Lamp PAR56 halogen 300 watts and a Lamp PAR56 11.5W , color white

Other LED solutions:

PAR56 projectors, PAR56 lamps and Flat projectors



PAR56 projectors



DESCRIPTION

PAR56 underwater lamp, improves energy efficiency compared to the traditional 300 W halogen PAR56 lamps. It must always be installed completely submerged. The lamps PAR56 are directly retrofittable with halogen 300 W lamps / projectors.

Lifespan of 25000 h.

The RGB lamp is controlled by a remote control, which is included, with a 2 m range and can control 2 lamps. The White lamp does not include remote control.

To correctly light a pool it is advisable to install a light from this range every 15 m² of water surface.

Note: this recommendation applies to pools light in color with white light spotlights, but if there are RGB spotlights more should be fitted. In dark pools it is recommended to use more projectors per m².

Projectors PAR56 needs a niche (see page 331) to complete the installation. Projector Flat to wall installations is delivered with the accessory to install in concrete and polyester pools. To complete the installation in panel pools needs spare part kit 24765-0500.

How to replace a PAR56 lamp?



TECHNICAL FEATURES

PAR56 projectors

	Light color	Embellisher	Code	Consumption	Luminous flux	
	White			11.5W (18VA)	1300 lm	
			White			74940
			Beige			74940CL090
			Light grey			74940CL129
	Anthracite grey		74940CL144			
	RGB		White	71742	15 W (23 VA)	900 lm
			Beige	71742CL090		
			Light grey	71742CL129		
Anthracite grey			71742CL144			

Must be connected to a 12VAC safety transformer. 2.5 m cable. IPX8 protection.

PAR56 lamps

	Light color	Code	Consumption	Luminous flux		
	White		11.5W (18VA)	1300 lm		
					White	74939
	RGB			White	71740	15 W (23 VA)

Must be connected to a 12VAC safety transformer. IPX8 protection.

Flat projectors

	Light color	Code	Consumption	Luminous flux		
	White		11.5W (18VA)	1300 lm		
					White	74941
	RGB			White	71744	15 W (23 VA)

Must be connected to a 12VAC safety transformer. 2.5 m cable. IPX8 protection.

HALOGEN LIGHTING

Standard light



According to UE Regulation 2019/2020, from September 1st, 2021 halogen cannot be sold anymore on the European Union market. This is also valid in other countries such as UK and Qatar.



DESCRIPTION

All plastic materials. PAR56 300W 12V AC halogen lamp.

For correct pool lighting, we recommend: one projector per 25-30 m² of pool area. This recommendation is valid for light coloured pools. For pools in dark colours or stainless steel, we recommend a higher proportion of projectors per m².

The projector must be always be submerged in water.

Projectors for installation in "standard" niche (included).

TECHNICAL FEATURES

Standard light

Type of pool	Cable 2x6 mm ² 2.5 m	Type of decorative ring Ø280 mm		Consumption	Niche included
		ABS	S.S.		
Concrete	Yes	07844	07843	300W (300 VA)	Yes
	No	07838	07837		
Prefabricated	Yes	07856	07855		
	No	07852	07851		

Rated voltage: 12 V AC. Protection rating: IPX8. Compatible with standard niches (included).

According to UE Regulation 2019/2020, from September 1st, 2021 halogen cannot be sold anymore on the European Union market. This is also valid in other countries such as UK and Qatar.



Global light



DESCRIPTION

Made of plastic with hardware and anchoring system also made of plastic. Suitable for sea water.

Model based on standard projector. PAR56 300W 12V AC halogen lamp.

For correct pool lighting, we recommend one projector per 25-30 m² of pool area. This recommendation is valid for light coloured pools. For pools in dark colours or stainless steel, we recommend a higher proportion of projectors per m².

The projector must be always be submerged in water.

Compatible with AstralPool niches (not included) or any niche available on the market with interior diameters ranging between 220 mm and 235 mm (e.g.: Standard model and PS model).

For full projector assembly, the niche must be purchased separately (see page 331).

TECHNICAL FEATURES

Global light

Type of pool	Cable 2x6 mm ² 2.5 m	Type of decorative ring Ø280 mm	Consumption	Niche included
		ABS		
All depending on the niche	Yes	52608 	300W (300 VA)	No

Rated voltage: 12 V AC. Protection rating: IPX8. Compatible with standard and PS niches (not included).

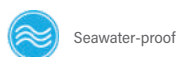

Seawater-proof

Mini light

According to UE Regulation 2019/2020, from September 1st, 2021 halogen cannot be sold anymore on the European Union market. This is also valid in other countries such as UK and Qatar.



Fast assembly Mini light

DESCRIPTION

Small underwater projector. GX-5.3 50W 12V AC aluminized halogen lamp.

For correct pool lighting, we recommend one projector per 10 m² of pool area. This recommendation is valid for light coloured pools. For pools in dark colours or stainless steel, we recommend a higher proportion of projectors per m².

The projector must be always be submerged in water.

Projectors for installation in bushings or niche, depending on model (not included). To complete the installation the right housing should be purchased for each type of pool (see page 331). This recommendation is valid for light coloured pools. For pools in dark colours or stainless steel, we recommend a higher proportion of projectors per m².

TECHNICAL FEATURES

Fast assembly Mini light

	Body	Type of decorative ring Ø96 mm		Consumption	Fixing
		ABS			
	Plastic	33708		50W (50 VA)	Ø63 wall conduit or Fast assembly Mini Niche
	Metal	33684			

Rated voltage: 12V AC. IPX8 protection. Includes 2.5 m H07RN-F 2 x 1.5 mm² cable. Compatible with a 63 bushing (code 15661) or snap-in mini niche (not included). Select the appropriate option for each pool (see page 331).

Mini light for Spa and prefabricated pool

	Body	Type of decorative ring Ø96 mm		Consumption	Fixing
		ABS	S.S.		
	Plastic	33709	36647	50W (50 VA)	Threaded body and 2" nut
	Metal	33685	36642		

Rated voltage: 12 V AC. Protection rating: IPX8. Includes 2.5-m H07RN-F 2 x 1.5 mm² cable.

Mini light for Mini Niche (Light spot)

	Body	Type of decorative ring Ø96 mm		Consumption	Fixing	Niche included
		ABS	S.S.			
	Plastic	49820	49821	50W (50 VA)	Mini niche	No
	Metal	49822	49823			

Rated voltage: 12V AC. IPX8 protection. Includes 2.5 m H07RN-F 2 x 1.5 mm² cable. Compatible with mini niche (not included). Select the appropriate option for each pool (see page 331).

Lamps

According to UE Regulation 2019/2020, from September 1st, 2021 halogen cannot be sold anymore on the European Union market. This is also valid in other countries such as UK and Qatar.



TECHNICAL FEATURES

Lamps for lights

Type of lamp		Code	Consumption
Halogen PAR56	For lights with niche	00370	300W (12 V)
Dichroic GX-5.3	For mini lights	19334	50W (12 V)

NICHES

Standard niches



TECHNICAL FEATURES

Niches				
Concrete pool	Prefabricated pools		Panels pool	
	With inserts	Without inserts	With inserts	Without inserts
00349 	00364	28887	23671	23670
	17805	72261		

Compatible with: LumiPlus FlexiNiche, LumiPlus PAR56 series, Standard and Global halogen lights and PAR56 Aquasphere projectors



AISI-316L stainless steel niches

TECHNICAL FEATURES

AISI-36 stainless steel niches	
Concrete pools	Liner swimming pool
54102	54103

Compatible with: LumiPlus FlexiNiche in Stainless Steel, LumiPlus stainless PAR56 steel range and stainless steel incandescent projectors.



PS niches

TECHNICAL FEATURES

PS niches		
Concrete pool	Prefabricated pools	
	With inserts	Without inserts
00355 	-	00367

Compatible with: LumiPlus FlexiNiche, Global and PAR56 Aquasphere projectors.

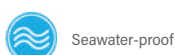

Seawater-proof



Niches for projector DESIGN

and also compatibles with LumiPlus FlexiNiche



TECHNICAL FEATURES

Niches			
Concrete pool	Prefabricated pools		Fixing kit for other niches
	With inserts	Without inserts	
59813 	59814	59815	59818*

Compatible with: LumiPlus FlexiNiche ABS and Stainless Steel and LumiPlus Design.

* Fitting kit to install LumiPlus Design to the majority of niches from Ø180 to Ø190 mm on the market (Hugo Lahme, MTS Productksts, Wibre...).



Mini niches



TECHNICAL FEATURES

MINI niches		
Concrete pool	Prefabricated pools	Panel pools
06967 	00369	49828

Compatible LumiPlus FlexiMini V1 and V2; LumiPlus Mini V2 series and Mini halogen lights for niche.



Mini niche with integrated nozzle for fast assembly Mini projectors



TECHNICAL FEATURES

Mini niche with integrated nozzle for fast assembly Mini projectors	
Concrete pools	Prefabricated pools
53956 	59983

53956: Compatible with the LumiPlus FlexiMini V1 and V2; LumiPlus Mini V2; LumiPlus V3, LumiPlus FlexiRapid and Mini halogen snap-in ranges.

59983: Compatible with the LumiPlus FlexiMini V1 and V2; LumiPlus Mini V3 and LumiPlus FlexiRapid ranges.



Transformers for pool and fountain lighting



More compact.
More functional.
Specially designed for lighting up fountains and pools.

DESCRIPTION

- Suitable for all types of circuit board.
- Quick and easy installation.
- Connection via terminals protected against indirect contacts.
- Up to 40 m between the spotlight and transformer.
- Made in compliance with Standard UNE-EN-61558-2-6.
- IP-20 protection rating.
- Age-resistant housing.

	Code	Standard Pack	Standard weight in kg	Standard volume in m ³
100 VA 230 V to 12 V transformer	00383-1369	-	-	-
300 VA 230 V to 12 V transformer	00384-1369	-	-	-
600 VA 230 V to 12 V transformer	00385-1369	-	-	-



Transformers



DESCRIPTION

Made in compliance with standard EN 60742.

	Code	Standard Pack	Standard weight in kg	Standard volume in m ³
130VA from 230V to 12V	00383-4146	6	15.0	0.011
300VA from 230V to 12V cable length up to 35 m	71436	4	21.0	0.012
600VA from 230V to 12V cable length up to 25 m	00385-4146	2	19.0	0.012

Alternative transformer range, on enquiry.



Encapsulated security transformer with IP-65 protection rating for pools



DESCRIPTION

Manufactured according to the rules UNE-EN 61558 and directive CE.

- Bodywork has IP-657 protection rating.
- Class II transformer. Total protection against all electric shocks.
- Self-extinguishing bodywork, as per IEC 695-2-1
- Frequency of 50-60 Hz.

	Code	Standard Pack	Standard weight in kg	Standard volume in m ³
130 VA from 220-240 V to 12 V	35807	1	3.2	0.02
400 VA from 220-240 V to 12-17 V	35385	1	6.8	0.04
800 VA from 280-240 V to 12-17 V	35386	1	10.4	0.04

Transformer protection boxes



DESCRIPTION

Made of zinc plated steel plate, painted finish.

	Code	Standard Pack	Standard weight in kg	Standard volume in m ³
For transformer 00383	00386	1	1.15	0.01
For transformer 00384	00387	1	1.57	0.01
For transformer 00385	00388	1	3.00	0.01

Connection box with security cover

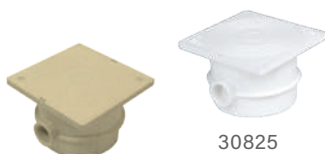

30825CL090

30825

DESCRIPTION

Manufactured in ABS, made up of three 3/4" inlets/outlets M-25 and 3/4" thread connections.

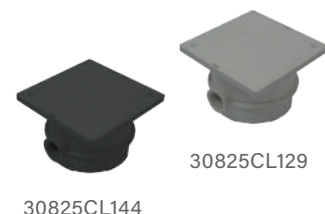

30825CL144

30825CL129

	Code	Standard Pack	Standard weight in kg	Standard volume in m ³
White	30825	12	4.65	0.030
Beige	30825CL090	12	4.65	0.030
Light Grey	30825CL129	12	4.65	0.030
Anthracite	30825CL144	12	4.65	0.030

Connection boxes for gluing pipes Ø50 mm



65215CL090

65215



65215CL144

65215CL129

	Code	Standard Pack	Standard weight in kg	Standard volume in m ³
White	65215	8	3.8	0.030
Beige	65215CL090	8	3.8	0.030
Light Grey	65215CL129	8	3.8	0.030
Anthracite	65215CL144	8	3.8	0.030

Connection box



DESCRIPTION

In AISI-316 stainless steel. Two PG 15 thread side outlets with two PG16 to M25 converters.

3/4" BSP threaded bottom connection.

	Code	Standard Pack	Standard weight in kg	Standard volume in m ³
Connection box	00393	1	0.21	0.002

TRANSFORMERS AND ACCESSORIES

Flexible conduit hose



DESCRIPTION

For connection from light to connection box, length 1 m hose.

	Code	Standard Pack	Standard weight in kg	Standard volume in m ³
Threaded ends 3/4" & M25	28138	1	-	-
M-25 socket joint	10892-0404	1	-	-
Threaded ends 3/4" and M26 150 cm	28138-150	1	-	-

Cable roll H07RN-F



	Code	Standard Pack	Standard weight in kg	Standard volume in m ³
Cable 2x1.5mm ² - 5m.	74652	1	-	0.01
Cable 2x1.5mm ² - 10m.	74656	1	-	0.01
Cable 2x1.5mm ² - 15m.	74657	1	-	0.01
Cable 2x1.5mm ² - 20m.	74658	1	-	0.01
Cable 2x1.5mm ² - 25m.	74659	1	-	0.01
Cable 2x1.5mm ² - 30m.	74673	1	-	0.01
Cable 2x2.5mm ² - 10m.	71645	1	-	0.01
Cable 2x2.5mm ² - 15m.	71646	1	-	0.01
Cable 2x2.5mm ² - 20m.	71647	1	-	0.01
Cable 2x2.5mm ² - 25m.	71648	1	-	0.01
Cable 2x2.5mm ² - 30m.	71649	1	-	0.01
100m cable roll	15264	1	187.5	-



Underwater connection kit



DESCRIPTION

The kit has all the necessary components to carry out any watertight connection. Due to the properties of the product, the resin seals all gaps. Maximum safety, easy installation, in 2 hours it is ready to be submerged.

	Code	Standard Pack	Standard weight in kg	Standard volume in m ³
Kit for Ø 13 to 15 mm cables	32803	1	0.3	0.002
Kit for Ø 8 to 12 mm cables	35661	1	0.3	0.002

Underwater connector

with IP68 protection rating and 4 poles



DESCRIPTION

Includes 5 connectors and two wrenches.

	Code	Standard Pack	Standard weight in kg	Standard volume in m ³
Overhead connector	71318	24	4.2	0.3

Aquarmony Loudspeaker



DESCRIPTION

With frontal installation. To listen to music and voice underwater creating a magical and different atmosphere. Aquarmony is a sealed waterproof loudspeaker designed for your pool. It is made of high quality components, innovative technology and with an assembly system assuring a correct operation in salt water or with a high Chlorine content. Easy installation.

	Code	Standard Pack	Standard weight in kg	Standard volume in m ³
Aquarmony Loudspeaker	25680	-	-	-
Niche for concrete pool	00349	-	-	-
Niche for liner pool	00364	-	-	-

Note: The niches come with a stuffing box assembly and a 1.5-m cable grommet specially designed for the Aquarmony range



TECHNICAL FEATURES

Maximum power	60 W
Impedance	4 ohm
Frequency	200-12000 Hz
Maximum area per loudspeaker	80 m ²
Maximum installation depth	40 cm
Weight	5 Kg
Cable length supplied	5 m

Amplifier and loudspeakers

RK400S



DESCRIPTION

- Built-in SELV power pack with all required protection ratings and safety systems.
- Fully insulated input and output ports, in compliance with standard ENV 61558-1 CEI EN 64-8/7, Section 702.
- RCA stereo input port compatible with any source (CD player, MP3 player, smartphone, etc.).
- Input and output XLR link for connecting other RK400-S devices together.
- Automated equalizers and limiters specially redesigned by Aquarmony.
- Automatic gain control, which does not require volume buttons.
- Four 60 W RMS amplifiers that work separately.
- Output through a gold-plated screw connector.
- On/off and signal display light.

	Code	Standard Pack	Standard weight in kg	Standard volume in m ³
Amplifier and loudspeakers	RK400S	1	-	-

TECHNICAL FEATURES

Maximum power	4 x 60 W rms
Impedance	4 ohm
Frequency	50-20,000 Hz
Weight	3.6 Kg





POOL LINING MATERIAL

ASTRALPOOL 

 **SOPREMA**

RENOLIT
ALKORPLAN

- | | | | |
|-----|--|-----|--|
| 342 | Soprema Pool 180/100 reinforced liner | 357 | Liner accessories |
| 343 | Soprema Pool 150/100 reinforced liner | 361 | Classification of liners depending on the pool |
| 347 | Alkorplan 200/100 reinforced liner | 362 | Liners for stairs |
| 349 | Alkorplan 150/100 reinforced liner | 372 | Glass tiling for spas and wellness facilities |
| 353 | Alkorplan liner accessories | 373 | Glass tiling: Projects |
| 355 | Pool shell accessories special for liner pool renovation | 375 | Liner and Glass tiles accessory |
| | | 375 | Under water reparations solutions |

ASTRALPOOL RECOMMENDATION

POOL FINISH COLOURS

Colours of pool shell materials recommended by AstralPool depending on the colour of your pool's finish.



POOL FINISH COLOURS



LIGHT BLUE



ADRIATIC BLUE



CARIBBEAN GREEN



WHITE

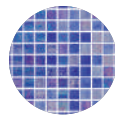

67497

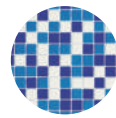

54357

ASTRALPOOL RECOMMENDATION POOL SHELL



WHITE



SAND



RELAX



SUBLIME

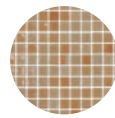

54316



54324

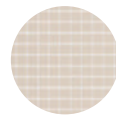

54256 (MATT - C3)



BEIGE CLO90 RAL1015



LIGHT GREY



PLATINUM



VANITY

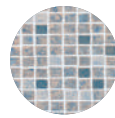

SAND PERSIA

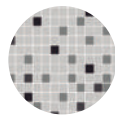

FADED MIX

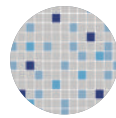

LIGHT GREY CL129 RAL7004



DARK GREY



ELEGANCE

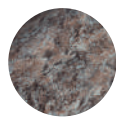

AUTHENTIC

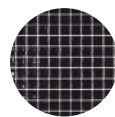

54398

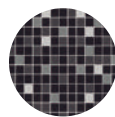

FADED MIX

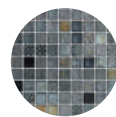

66717



ANTHRACITE CL144 RAL7016

SOPREMA POOL 180/100 AND 150/100 REINFORCED LINER

- + Optimal weldability.**
- + U.V. ray resistance.**
- + Resistance against microorganisms with "Bio Shield" treatment.**
- + Insensitivity to hot-cold cycles.**



SOPREMA, world leader in waterproofing solutions, offers a big range of reinforced membranes PVC for swimming pools.

4 LAYER MEMBRANE

Synthetic reinforced PVC membranes manufactured by impregnation with high quality raw materials (resins, plasticizers, stabilizers and pigments).

Composed of 4 layers with different and complementary formulations, introducing a polyester reinforcement between the second and third layers.

This reinforcement provides the membrane with great tensile strength and high dimensional stability.

«BIO-SHIELD» TREATMENT

Its formulation with "BIO-SHIELD" treatment guarantees total resistance to the formation of microorganisms and prevents any molecular change.

GUARANTEE

The minimum guarantee offered for all membranes is 10 years. Depending on the type of membrane, the guarantees are extended.

Consult the details of the extended guarantees on each line.





3D membrane

- + Attractive and aesthetic
- + Fast installation
- + Sensory experience



Sensitive White



Sensitive Sand



Sensitive Grey

DESCRIPTION

The 3D range replicates the feeling and the aesthetic aspects of mosaics and natural materials. The relief motifs, of great aesthetic appeal, are a plus to the characteristic advantages of reinforced PVC cladding: a simple and quick installation and a great protective and waterproofing capacity. All 3D membranes comply with EN 15836 and DIN 51097 anti-slip regulations.

PVC reinforced membrane of 1.8 mm and 1.5 mm with protection against UV and microorganisms.

- Roll of 1.65 x 25 m.
- 12 years waterproofing guarantee.
- 3 years antibacterial stains guarantee

	Code	Standard Pack	Standard weight in kg	Standard volume in m ³
1.8 mm thicknes				
Sensitive White	156988/SSHB	-	-	-
Sensitive Sand	156988/SSSA	-	-	-
Sensitive Grey	156988/SSGM	-	-	-
Sensitive Black	156988/SSNB	-	-	-
Sensitive Bali	156988/SSBA	-	-	-
Sensitive Bali Sand	156988/SSBS	-	-	-
1.5 mm thicknes				
Spirit Ceram Blue	157009/SCB	-	-	-
Spirit Ceram Grey	157009/SCG	-	-	-



3D COLOURS



Sensitive White

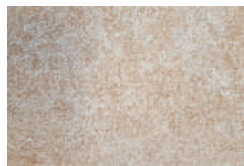

Sensitive Sand

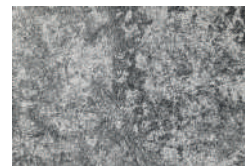

Sensitive Grey



Sensitive Black

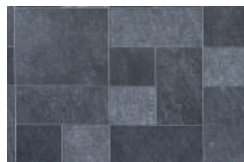

Sensitive Bali

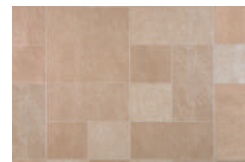

Sensitive Bali Sand

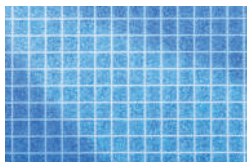

Spirit Ceram Blue



Spirit Ceram Grey



PREMIUM membrane



Basalt Grey



Sand

DESCRIPTION

PVC reinforced membrane of 1.5 mm with varnished coating superior protection against UV and microorganisms.

Premium:

- Roll of 1.65 x 25 m.
- 12 years waterproofing guarantee.
- 3 years antibacterial stains guarantee.

Grip (Anti-slip version):

- Roll of 1.65 x 10 m.
- 10 years waterproofing guarantee.

	Code	Standard Pack	Standard weight in kg	Standard volume in m ³
Premium				
Light Blue	156967/CA	-	-	-
Blue	156967/AB	-	-	-
Dark Blue	156967/DB	-	-	-
White	156967/HB	-	-	-
Sand	156967/SA	-	-	-
Light Grey	156967/GC	-	-	-
Medium Grey	156967/GM	-	-	-
Basalt Grey	156967/GA	-	-	-
Black	156967/NB	-	-	-
Wild Musk	156967/VM	-	-	-
Grip				
Light Blue	156991/CA	-	-	-
Blue	156991/AB	-	-	-
Dark Blue	156991/DB	-	-	-
White	156991/HB	-	-	-
Sand	156991/SA	-	-	-
Light Grey	156991/GC	-	-	-
Medium Grey	156991/GM	-	-	-
Basalt Grey	156991/GA	-	-	-
Black	156991/NB	-	-	-
Wild Musk	156991/VM	-	-	-

COLOURS



Light Blue



Blue



Dark Blue

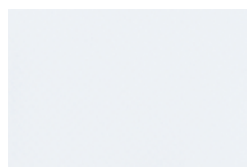

White

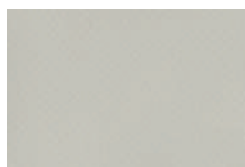

Sand



Light Grey



Medium Grey



Basalt Grey



Black



Wild Musk



DESIGN membrane



Marbella Blue

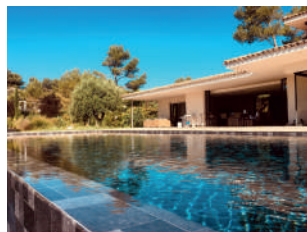

Bali

DESCRIPTION

PVC reinforced membrane of 1.5 mm with varnished coating superior protection against UV and microorganisms.

Design:

- Roll of 1.65 x 25 m.
- 12 years waterproofing guarantee.
- 3 years antibacterial stains guarantee.

Grip (Anti-slip version):

- Roll of 1.65 x 10 m.
- 10 years waterproofing guarantee.

	Code	Standard Pack	Standard weight in kg	Standard volume in m ³
Premium				
Marbella Blue	156975/MMB	-	-	-
Marbella Black	156975/MMBK	-	-	-
Marbella Grey	156975/MMG	-	-	-
Mosaic Blue	156975/MNB	-	-	-
Bali	156975/BALI	-	-	-
Bali Sand	156975/SDBA	-	-	-
Pearl Black	156975/PB	-	-	-
Sky Blue	156975/SB	-	-	-
Grip				
Marbella Blue	156991/MMB	-	-	-
Marbella Black	156991/MMBK	-	-	-
Marbella Grey	156991/MMG	-	-	-
Mosaic Blue	156991/MNB	-	-	-
Bali	156991/BALI	-	-	-
Bali Sand	156991/SDBA	-	-	-

COLOURS

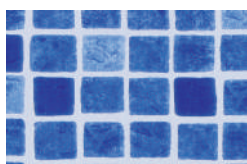

Marbella Blue

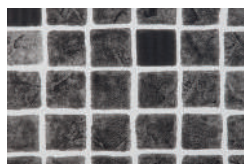

Marbella Black

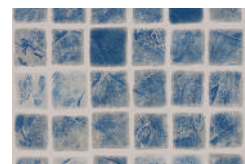

Marbella Grey

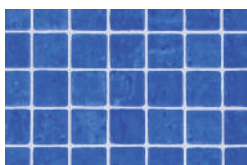

Mosaic Blue

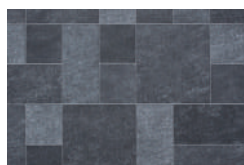

Bali

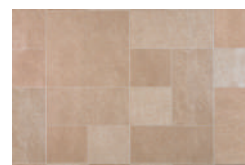

Bali Sand

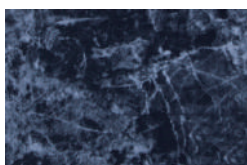

Pearl Black

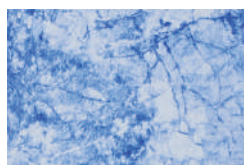

Sky Blue



ONE membrane

DESCRIPTION

PVC reinforced membrane of 1.5 mm with protection standard against UV and microorganisms. 10 years waterproofing guarantee.

One:

- Roll of 1.65 x 25 m.

Grip (Anti-slip version):

- Roll of 1.65 x 10 m.



White

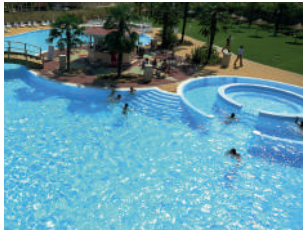

Light Blue

	Code	Standard Pack	Standard weight in kg	Standard volume in m ³
One				
Light Blue	156966/CA	-	-	-
Blue	156966/AB	-	-	-
Blue Saphir	156966/BS	-	-	-
Caribbean Green	156966/VC	-	-	-
Natural Green	156966/VG	-	-	-
White	156966/HB	-	-	-
Sand	156966/SA	-	-	-
Light Grey	156966/GC	-	-	-
Medium Grey	156966/GM	-	-	-
Basalt Grey	156966/GA	-	-	-
Grip				
Light Blue	156991/CA	-	-	-
Blue	156991/AB	-	-	-
Blue Saphir	156991/BS	-	-	-
Caribbean Green	156991/VC	-	-	-
Natural Green	156991/VG	-	-	-
White	156991/HB	-	-	-
Sand	156991/SA	-	-	-
Light Grey	156991/GC	-	-	-
Medium Grey	156991/GM	-	-	-
Basalt Grey	156991/GA	-	-	-

COLOURS



Light Blue



Blue



Blue Saphir



Caribbean Green



Natural Green



White

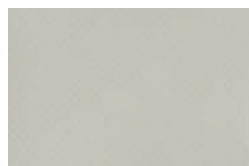

Sand



Light Grey



Medium Grey



Basalt Grey



PVC Liquid Premium / Design



	Code	Standard Pack	Standard weight in kg	Standard volume in m ³
1 litre pot.				
Light Blue	156992/CA	-	-	-
Blue	156992/AB	-	-	-
Dark Blue	156992/DB	-	-	-
Caribbean Green	156992/VC	-	-	-
Wild Musk	156992/VM	-	-	-
White	156992/HB	-	-	-
Sand	156992/SA	-	-	-
Light Grey	156992/GC	-	-	-
Medium Grey	156992/GM	-	-	-
Basalt Grey	156992/GA	-	-	-
Black	156992/NB	-	-	-
Blue Saphir	156992/BS	-	-	-
Green Natural	156992/VG	-	-	-
Transparent	156992/FTA	-	-	-



PVC Liquid 3D

	Code	Standard Pack	Standard weight in kg	Standard volume in m ³
1 litre pot.				
Sensitive White	156992/SSHB	-	-	-
Sensitive Sand	156992/SSSA	-	-	-
Sensitive Grey	156992/SSGM	-	-	-
Sensitive Black	156992/SSNB	-	-	-

RENOLIT ALKORPLAN
TOUCH

3D ALKORPLAN TOUCH

membrane

DESCRIPTION

Inspired by nature, the designs bring beauty, elegance and character to each pool with a surprising touch, inviting you to caress the surface. This revolution in reinforced membranes for the lining of pools is now available in 3D. Surrender to the appeal of TOUCH and make any pool look spectacular.

	Code	Standard Pack	Standard weight in kg	Standard volume in m ³
TOUCH 1.65 x 21 m				
Elegance	74436	-	-	-
Relax	58533	-	-	-
Authentic	58534	-	-	-
Vanity	67968	-	-	-
Sublime	67969	-	-	-
Prestige	67970	-	-	-
Origin	74180	-	-	-

COLOURS

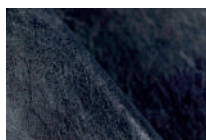

Elegance



Relax



Authentic



Vanity



Sublime

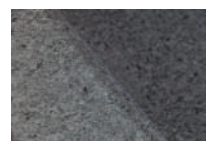

Prestige



Origin

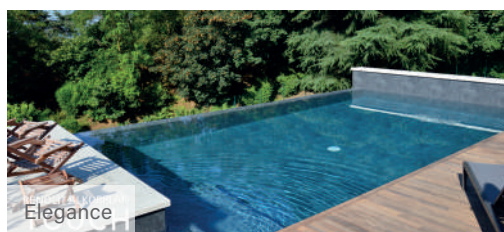

Elegance

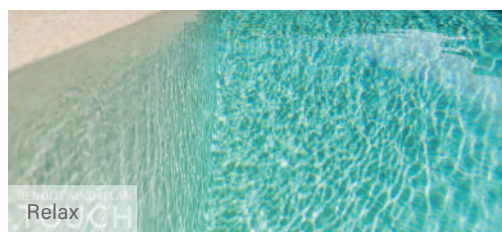

Relax

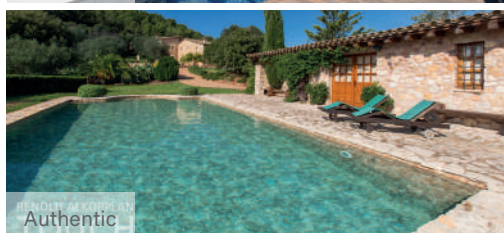

Authentic

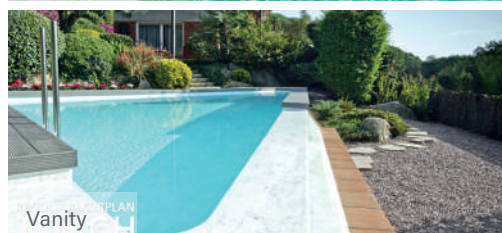

Vanity



Sublime

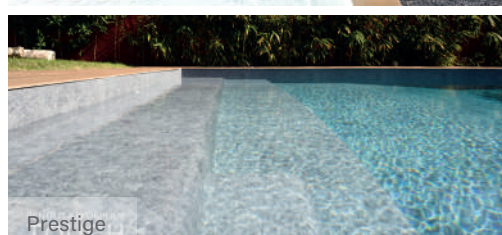

Prestige



Origin

RENOLIT ALKORPLAN CERAMICS



ALKORPLAN CERAMICS

reinforced membrane

DESCRIPTION

ALKORPLAN CERAMICS is a reinforced 2-mm embossed membrane for pools that imitates the volume of real glass tiling and its joints to look like a mosaic inspired in Greek mythology. Length: 21 m.

- Watertightness guaranteed.
- Quick to fit in comparison with glass tiling.
- The ceramic pieces on ALKORPLAN CERAMICS do not fall off.
- Minimum maintenance.
- More resistant and long-lasting thanks to its 2-mm thickness.
- Embossed coating that makes it look like real glass tiling.

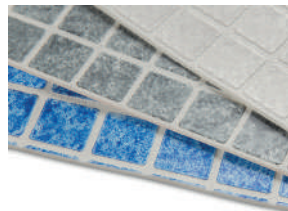

	Code	Standard Pack	Standard weight in kg	Standard volume in m ³
1.65 mm width				
Atenea	70673	-	-	-
Selene	70674	-	-	-
Etna	70676	-	-	-

COLOURS

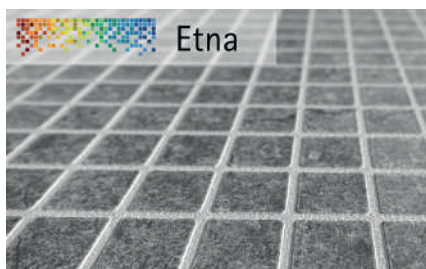
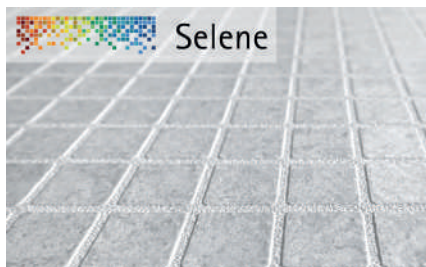
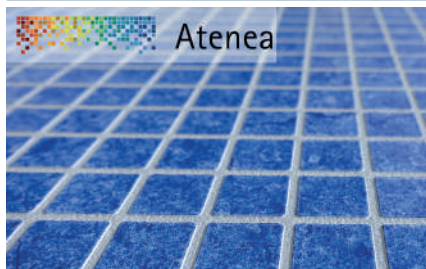

ALKORPLAN XTREME membrane



DESCRIPTION

ALKORPLAN XTREME is the only reinforced membrane in the market whose colour is resistant to chlorine and stains, even those that usually form on the waterline.

ALKORPLAN XTREME is a smooth, flexible and robust reinforced membrane, thanks to the most advanced technological developments, and it has been made to resist the wear and tear inherent to the daily use of a pool. It is even resistant if there is a continuous large influx of swimmers in a pool and aggressive chemical products are used to treat it.

	Code	Standard Pack	Standard weight in kg	Standard volume in m ³
1.65 mm width				
Ice	70199	-	-	-
Sahara	70200	-	-	-
Blue Fresh	70217	-	-	-
Blue	70218	-	-	-
Silver	70222	-	-	-
Vulcano	70223	-	-	-
Onix	70224	-	-	-
2.05 mm width				
Ice	70225	-	-	-
Blue fresh	70228	-	-	-
Anti-slip 1.65 mm width				
Ice	70229	-	-	-
Sahara	70230	-	-	-
Blue Fresh	70232	-	-	-
Blue	70233	-	-	-
Silver	70235	-	-	-
Vulcano	70236	-	-	-
Onix	69392	-	-	-

COLOURS

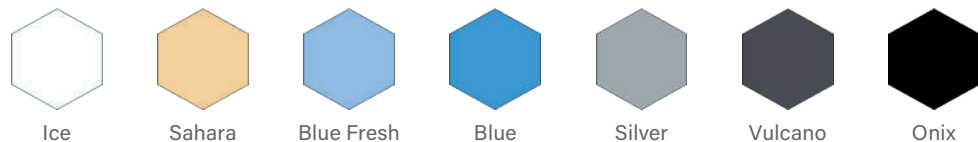

POOL LINING MATERIAL

RENOLIT ALKORPLAN

ALKORPLAN2000 reinforced membrane

DESCRIPTION

Reinforced monochrome membrane, coated in a varnish made of a special formulation that protects it from external wear and tear.

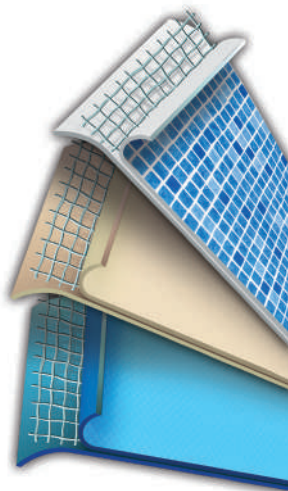

	Code	Standard Pack	Standard weight in kg	Standard volume in m ³
1.65 x 25 m				
Light Blue	49908	-	-	-
Adriatic Blue	49909	-	-	-
White	49911	-	-	-
Sand	49912	-	-	-
Light Grey	49913	-	-	-
Dark Grey	49914	-	-	-
2.05 x 25 m				
Light Blue	49908-205	-	-	-
Adriatic Blue	49909-205	-	-	-
White	49911-205	-	-	-
Sand	49912-205	-	-	-
Light Grey	49913-205	-	-	-
Dark Grey	49914-205	-	-	-
Green	49910-205	-	-	-
Anti-slip - 1.65 x 12.60 m				
Light Blue	66117	-	-	-
Adriatic Blue	66115	-	-	-
Caribbean Green	66116	-	-	-
White	66114	-	-	-
Sand	66118	-	-	-
Light Grey	66119	-	-	-
Dark Grey	66983	-	-	-

COLOURS

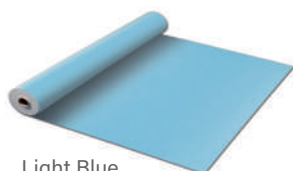

Light Blue

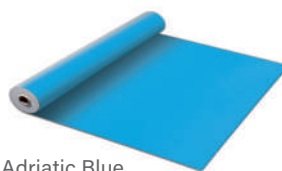

Adriatic Blue



White

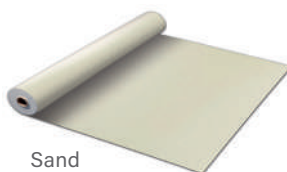

Sand



Light Grey



Dark Grey

RENOLIT ALKORPLAN

ALKORPLAN3000 membrane

DESCRIPTION

Reinforced decorated membrane, coated in a varnish made of a special formulation that protects it from external wear and tear.

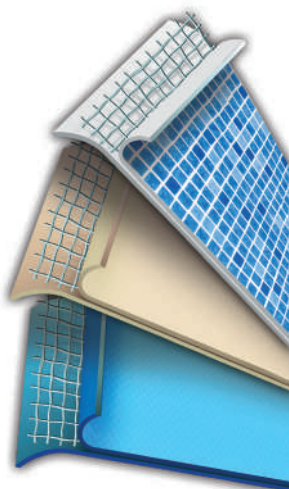

	Code	Standard Pack	Standard weight in kg	Standard volume in m ³
1.65 x 25 m				
Byzanz Blue	49916	-	-	-
Carrara	49919	-	-	-
Marble	49920	-	-	-
Blue Persia	49921	-	-	-
Sand Persia	49907	-	-	-
Anti-slip - 1.65 x 12.60 m				
Blue Persia	67283	-	-	-

COLOURS

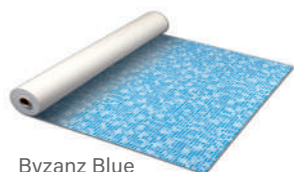

Byzanz Blue

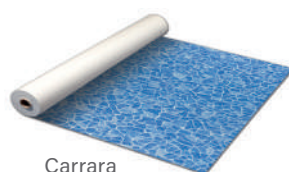

Carrara

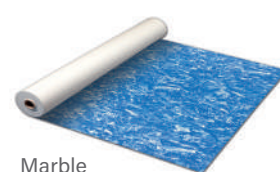

Marble

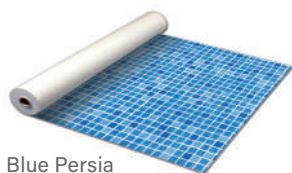

Blue Persia

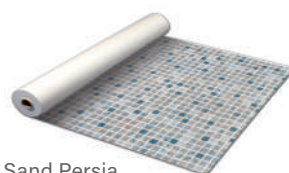

Sand Persia

RENOLIT ALKORPLAN NATURAL POOL

RENOLIT ALKORPLAN NATURAL POOL



DESCRIPTION

RENOLIT ALKORPLAN NATURAL POOL gives an extra dimension to your garden in summer and winter time. In summer the whole family can enjoy a refreshing dive in the cristal clear water. In winter the pool stays a natural water element in the garden. Waterproofing membrane of flexible polyvinyl chloride (PVC-P) with a polyester reinforcing. Designed for natural swimming pools and small swimming ponds for private use.

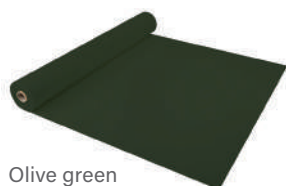

Olive green



Dark Grey



Black

	Code	Standard Pack	Standard weight in kg	Standard volume in m ³
1.5 m x 2.05 m				
Olive green	73015	-	-	-
Dark grey	73017	-	-	-
Black	73019	-	-	-

RENOLIT ALKORPLAN
VOGUE

RENOLIT ALKORPLAN Vogue

DESCRIPTION



Vintage



Urban



Summer

2mm premium membranes, with the same technology and quality as the Touch range but inspired by current interior and exterior decoration trends. Avant-garde designs that aim to respond to an audience that wants a unique, exclusive design pool with personality.

VOGUE is the new ALKORPLAN reinforced membrane with 2 mm thick. It is the strongest and most resistant on the market and its designs transform pools into true design objects. Inspiration comes from refined, modern and aesthetically avant-garde finishes to create dream pools.

	Code	Standard Pack	Standard weight in kg	Standard volume in m ³
Vintage	74975	-	-	-
Urban	74976	-	-	-
Summer	74977	-	-	-

RENOLIT ALKORPLAN



ALKORPLUS weld sealant for the ALKORPLAN 2000 and 3000 ranges

DESCRIPTION

Liquid PVC ALKORPLUS for sealing joints (1 litre tins/pack of 6 tins).

	Code	Standard Pack	Standard weight in kg	Standard volume in m ³
Light Grey	23600	-	-	-
Dark Grey	52619	-	-	-
Caribbean Green	52620	-	-	-
White	52622	-	-	-
Transparent	52623	-	-	-
Light Blue	52624	-	-	-
Adriatic Blue	12284	-	-	-
Sand	52626	-	-	-
Platinum	 52627	-	-	-

RENOLIT ALKORPLAN TOUCH



ALKORPLUS TOUCH weld sealant

DESCRIPTION

Specifically for fitting ALKORPLAN TOUCH membranes. Made using an innovative formulations that makes it more resistant to ageing and fading, thus prolonging the pool's service life and its perfect appearance by many years.

	Code	Standard Pack	Standard weight in kg	Standard volume in m ³
Elegance	60613	-	-	-
Relax	60614	-	-	-
Authentic	60615	-	-	-
Vanity	67971	-	-	-
Sublime	67972	-	-	-
Prestige	67973	-	-	-
Origin	74181	-	-	-

ALKORPLAN XTREME

Pools that stand up to anything!!



ALKORPLAN XTREME weld sealant

DESCRIPTION

ALKORPLAN XTREME weld sealant (1 litre tins/pack of 6 tins).

	Code	Standard Pack	Standard weight in kg	Standard volume in m ³
Ice	70266	-	-	-
Sahara	70268	-	-	-
Blue Fresh	70270	-	-	-
Blue	70272	-	-	-
Silver	70273	-	-	-
Vulcano	70274	-	-	-
Onix	69391	-	-	-

RENOLIT ALKORPLAN CERAMICS



ALKORPLAN CERAMICS

weld sealant

DESCRIPTION

Liquid PVC ALKORPLAN CERAMICS for finished welds (900 g tins/pack of 6 tins).

	Code	Standard Pack	Standard weight in kg	Standard volume in m ³
White	70678	-	-	-

RENOLIT ALKORPLAN



Renolit Alkorplan Lane Marker

DESCRIPTION

Black foil band for marking the streets in public and competition swimming pools. This black membrane and now, with more protection lacquer, offers greater resistance to whitening, designed for the harsh conditions of chemical treatment that usually occur in public pools..

	Code	Standard Pack	Standard weight in kg	Standard volume in m ³
Rail Bands (25 m x 0.25 m). Black colour	50798-150	-	-	-

RENOLIT ALKORPLAN



ALKORPLAN geotextile fungicide

DESCRIPTION

Felt made up of 400 g/m² light blue heat-welded polypropylene fibres treated with metal ion anti-bacterial organic additives to act as a stable fungicide. It is used as a protective layer between the ALKORPLAN membrane and the pool surface to prevent the proliferations of bacteria, fungi and micro-organisms, as well as imitating the irregular embossed surfaces that the pool may have had before fitting the liner. Bathers also find the bottom of the pool much more pleasant when they walk on the membrane. Length: 50 m. Light blue colour.

	Code	Standard Pack	Standard weight in kg	Standard volume in m ³
Width 1.50 m. For butt welding	69179	-	-	-
Width 1.65 m	66381	-	-	-
Width 2.00 m	66382	-	-	-

RENOLIT ALKORPLAN



Band for Testa installation

DESCRIPTION

Band to install the membrane RENOLIT ALKORPLAN TOUCH to testa, which is recommended to be done on swimming pool floors for a much more impeccable visual finish. Its use is indicated together with the geotextile felt, 300 g or 400 g, in floors to avoid visible mounds appear next to the joints and welds..

	Code	Standard Pack	Standard weight in kg	Standard volume in m ³
Butt welding band. Dark grey colour (1.5mm thickness x 15cm width x 20m length)	68828	-	-	-

EASYCOLOR Inlet Sheath

- + This kit of inlet sheath allows to change the color, both the embellisher and the floater.
- + This sheath could be installed without changing the skimmer mouth what is very practical to renew or upgrade pools.
- + This kit includes inlet sheath, floater, flanges and embellisher.



73166CL090



73166CL144



73166CL129



74035CL090



74035CL144



74035CL129

DESCRIPTION

Compatible with skimmer items 30866, 30867, 73158, 73159, 73160, 73161, 73162 and 73163.

	Code	Standard Pack	Standard weight in kg	Standard volume in m ³
Beige - inlet sheath	73166CL090	1	1.22	0.02
Light grey - inlet sheath	73166CL129	1	1.22	0.02
Anthracite grey - inlet sheath	73166CL144	1	1.22	0.02

DESCRIPTION

Compatible with skimmer items 00251, 00252, 01463, 01464, 11304, 11305, 11311, 11313, 11314 and 11317.

	Code	Standard Pack	Standard weight in kg	Standard volume in m ³
Beige - inlet sheath	74035CL090	1	1.22	0.022
Light grey - inlet sheath	74035CL129	1	1.22	0.022
Anthracite grey - inlet sheath	74035CL144	1	1.22	0.022

RENOLIT ALKORPLAN



Skimmer Adaptor

DESCRIPTION

The skimmer adaptor replaces the need to remove the previous skimmer, as it is inserted into the previous skimmer and sealed using ABS glue or marine silicone. It is only suitable for skimmers with an internal opening of 140 mm x 201 mm

	Code	Standard Pack	Standard weight in kg	Standard volume in m ³
	55977	1	1.3	0,02



74097



74097CL090



74097CL129



74097CL144

Main drain grille for pool standard compliance

DESCRIPTION

Grille to replace the grilles on already installed main drains in private pools, to meet pool regulations. Made of PP plastic. Compatible with main drains 01467, 27837, 27839.

	Code	Standard Pack	Standard weight in kg	Standard volume in m ³
Grille				
White	74097	6	3	0.033
Beige	74097CL090	6	3	0.033
Light grey	74097CL129	6	3	0.033
Anthracite grey	74097CL144	6	3	0.033



Multiflow threaded return inlet for liner pools



Complies with Standards
EN 16582-1
EN 16713-2

DESCRIPTION

Outer 2" thread, Ø 50mm inner. For liner pools. Comes in ABS, with gaskets and screws. Installation with bushing 15662 or 15663 is recommended (see page 148).

	Code	Standard Pack	Standard weight in kg	Standard volume in m ³
White	00330	12	4.5	0.020
Beige	00330CL090	12	4.5	0.020
Light Grey	00330CL129	12	4.5	0.020
Anthracite Grey	00330CL144	12	4.5	0.020



Complies with Standards
EN 16582-1
EN 16713-2

Suction nozzle for liner pools

DESCRIPTION

Outer 2" thread, internal Ø 50 mm. Made of white ABS. Comes with plug, gaskets and screws. Recommended for installation with wall conduit 15663.

	Code	Standard Pack	Standard weight in kg	Standard volume in m ³
Standard return inlet - White	00332	12	4.22	0.020
Beige	00332CL090	12	4.22	0.020
Light Grey	00332CL129	12	4.22	0.020
Anthracite Grey	00332CL144	12	4.22	0.020

For more pool shell elements dedicated to liner pools, see chapter pool shell equipment.

RENOLIT ALKORPLAN



PVC laminate

DESCRIPTION

Particularly suitable for fixing reinforced membrane in existing pools for renovation or for pools, where the horizontal surfaces are uneven or have irregularities.

	Code	Standard Pack	Standard weight in kg	Standard volume in m ³
PVC laminate (1.4mm thickness x 5cm width x 2m length)	58942	-	-	-

RENOLIT ALKORPLAN



Laminate 90° angle profile

DESCRIPTION

A Fixing with a 90° angle, suitable for new pools where the coping has not been fixed or for renovations where the crown can be removed and its upper surface of the pool structure is completely smooth.

	Code	Standard Pack	Standard weight in kg	Standard volume in m ³
Laminate 90° angle profile (1.4mm thickness x 4.5x4.5cm width x 2m length)	58944FE	-	-	-

RENOLIT ALKORPLAN



Laminate

DESCRIPTION

Ideal for pools with irregular shapes where the installer can design their own profiles with the angle and size required.

	Code	Standard Pack	Standard weight in kg	Standard volume in m ³
Laminate (1.4mm thickness, 1cm width x 2m length)	56307	-	-	-

RENOLIT ALKORPLAN



74762



74982

Bead receiver track

DESCRIPTION

50mm white PVC or aluminium profile in piece of 2 m. Suitable for both new pools and renovations, with the possibility of adapting to straight sections as well as curved sections.

	Code	Standard Pack	Standard weight in kg	Standard volume in m ³
PVC profile (5cm width x 2m length)	74762	-	-	-
Aluminium profile (5cm width x 2m length)	74982	-	-	-

6 mm Locking bead

RENOLIT ALKORPLAN



DESCRIPTION

Beading to lock the reinforced membrane anchorage when the hung system is used. It also has an aesthetic finishing function.

	Code	Standard Pack	Standard weight in kg	Standard volume in m ³
Locking bead. White colour (6 mm width x 50m lenght)	8GAYELLOW	-	-	-

RENOLIT ALKORPLAN



32324

Plate band for liners 150/100°

	Code	Standard Pack	Standard weight in kg	Standard volume in m ³
Galvanized plate band (2 x 0.05 m)	32324	-	-	-

Note: In the event of assembling a liner 150/100° by hung type fastening with an 8 mm strip, the accessories are the same as for liners 75/100° (see next page).

RENOLIT ALKORPLAN



Rivets

DESCRIPTION

Aluminium rivets.

	Code	Standard Pack	Standard weight in kg	Standard volume in m ³
25 x 4.8 mm	53795	3	8.0	0.01

RENOLIT ALKORPLAN

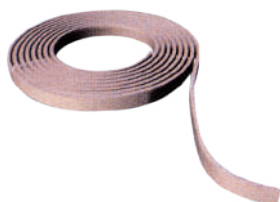

Double PVC hem

DESCRIPTION

Welded to the edge of the liner, allows the liner to attach to the pool shell, by using the corresponding profile.

	Code	Standard Pack	Standard weight in kg	Standard volume in m ³
	12184	250 m	9.0	0.036

LINER ACCESSORIES

RENOLIT ALKORPLAN



ALKORCLEAN waterline degreaser and ALKORPLUS stain remover

DESCRIPTION

The ALKORCLEAN degreaser is recommended for removing grease from the waterline, while the ALKORPLUS stain remover neutralises metal ions in the water such as copper.

The ALKORPLUS stain remover is a liquid to prevent stains by preventing dirt forming on the waterline.

	Code	Standard Pack	Standard weight in kg	Standard volume in m ³
ALKORCLEAN waterline degreaser	55976	-	-	-
Alkorplus stain remover	53898	-	-	-

RENOLIT ALKORPLAN



RENOLIT ALKORPLUS Structure Disinfectant

DESCRIPTION

An effective product for cleaning and disinfecting the structure prior to installing the lining, preventing the proliferation of microorganisms between the ground and the liner and, therefore, the appearance of irreversible stains. Transparent.

	Code	Standard Pack	Standard weight in kg	Standard volume in m ³
Pool Shell Disinfectant. 1L Transparent	53890	6	-	-

RENOLIT ALKORPLAN



RENOLIT ALKORPLUS THF Solvent

DESCRIPTION

THF (Tetrahydrofuran) is a solvent normally used to reduce the viscosity of liquid PVC or sealing lacquer. These products leave the factory with the correct viscosity, but since they are manufactured using volatile solvents, over time their viscosity increases. To reduce it, a small quantity of THF is added in the polyethylene bottle that the sealant contains. It can also be used as a PVC accessory cleaner (tubes, piping, etc.), before the application of the specific PVC glue.

	Code	Standard Pack	Standard weight in kg	Standard volume in m ³
THF solvent. 1L Transparent	64312	6	-	-

RENOLIT ALKORPLAN



RENOLIT ALKORPLUS MEC Solvent

DESCRIPTION

MEC (Methyl ethyl ketone or Butanone) is a solvent used commonly to reduce the viscosity of sealants manufactured with the same MEK solvent. These products leave the factory with the correct viscosity, but as they are manufactured based on volatile solvents, their viscosity increases over time. To reduce it, add a small amount of MEK to the polyethylene bottle containing the sealant. This product is suitable for 81022 (XTREME), 81023 (TOUCH) and 81024 sealants.

	Code	Standard Pack	Standard weight in kg	Standard volume in m ³
MEC solvent. 1L Transparent	74450	6	-	-

RENOLIT ALKORPLAN



RENOLIT ALKORGLUE

Neoprene-based contact glue

DESCRIPTION

The RENOLIT ALKORGLUE 81045 glue is a neoprene based contact adhesive. It is toluene-free and environmentally friendly. It will form a perfect bond between ALKORPLAN pool liner membrane, and geotextile 81006 to metal, wood, rigid PVC, concrete and other surfaces. It is not suitable for use in contact with expanded polystyrene.

	Code	Standard Pack
5 L Yellowish colour	70679	1
20 L Yellowish colour	74981	1

RENOLIT ALKORPLAN



RENOLIT ALKORGLUE Zero solvents

DESCRIPTION

Multipurpose glue free of organic solvents suitable for not damaging sensitive materials like geotextile fleece or polystyrene. Thanks to being in an aqueous suspension, it can be used as a wet, semi-wet or contact glue. It is non-flammable.

	Code	Standard Pack
20 L Beige colour	74465	1

RENOLIT ALKORPLAN



RENOLIT ALKORGLUE

Nitrile Rubber based thermo-adhesive

DESCRIPTION

RENOLIT ALKORGLUE is a toluene-free, Nitrile Rubber based glue. The volatile solvent make is quick-drying and it has high resistance to water, ageing and plasticisers. These factors make it especially suitable for mounting the membrane on cement and mortar, and on stairs and corners even when damp. It has the added advantage of being reactivated by a hot-air welder, for those occasions when the membrane has been left open for long periods.

	Code	Standard Pack
Quick-drying glue. 20 L Beige colour	53891	1

RENOLIT ALKORPLAN











Joint Sealant Application Bottle

	Code	Standard Pack
Dosing cap	53893	1
Joint sealant application bottle	53892	1

CLASSIFICATION OF LINERS DEPENDING ON THE POOL

Pool liners 75/100°

	Standard pool liners 75/100°	Non-Standard pool liners 75/100°
Solid colour models	Code	Code
Light blue	09278	05810 
France blue	09277	05809 
Caribbean green	09281 	05813 
White	09279 	05811
Sand	16131 	16137 
Printed colour models	Code	Code
Servanne	26668	26686
Mosaic	09280	05812 
Blue marble	16132	16138 
Green marble	16132V	16138V
Sand marble	16132A	16138A
Byzantium blue	26669	26678
Byzantium green	26670	26679

Consult us for pools of different designs and shapes

COLOURS





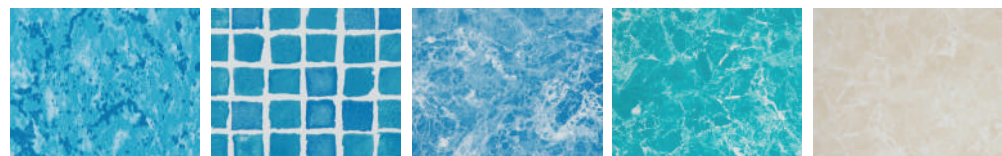

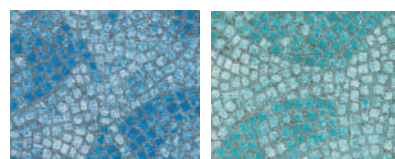

Light Blue France blue Caribbean Green Sand White

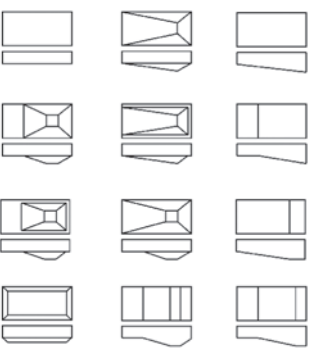

Servanne Mosaic Blue Marble Green Marble Sand Marble

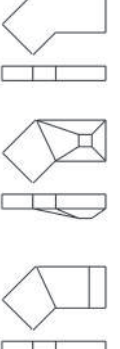
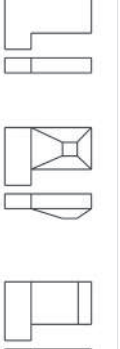
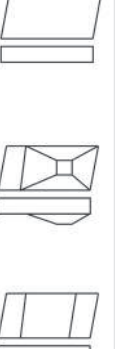

Byzantium blue Byzantium green

STANDARD POOLS				NON STANDARD POOLS				
Rectangular	Round	Oval	Ovoid shaped	Kidney	Lazy	Polygonal	Parallelogram	Trapezium
								

 Until end of stocks.

- Below we provide you with the details of the shapes and models you can choose from plain or printed liners to ensure you select the correct liner for your pool steps.
- Steps that are fitted along the breadth of the basin are invoiced in accordance with the standard model STRAIGHT as long as the width does not exceed 4 meters.
- Attention: the size of the basin should not include the depth of the steps.

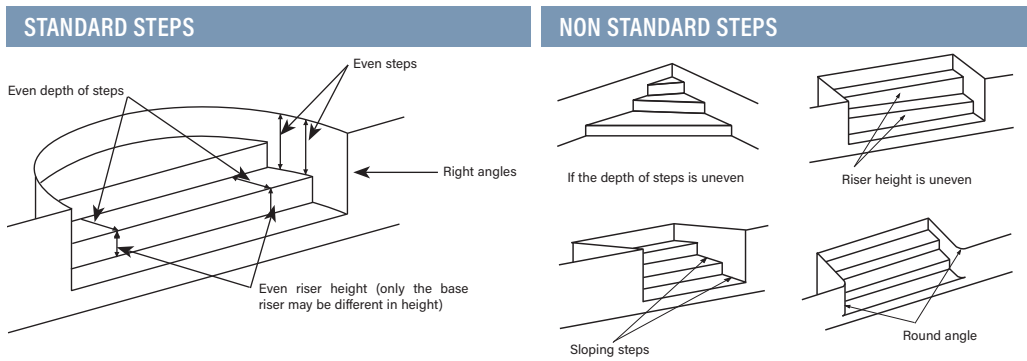

For steps that do not fit the Standard models shown here, request quote.

PLAIN LINERS FOR STAIRS

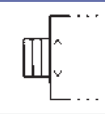
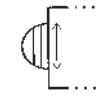
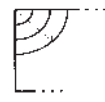
Steps		Plain Liner	Plain Liner + Bands	Diagram
Shape	Widths	Code	Code	
Straight	0 to 2 meters	05789	05789B	
	3 to 4 meters	05791	05791B	
Roman	0 to 2 meters	16163	16163B	
	2 to 3 meters	25868	25868B	
	3 to 4 meters	05800	05800B	
Right angle	0 to 2 meters	05803	05803B	
	2 to 3 meters	05804	05804B	
¼ Circle	0 to 2 meters	16167	16167B	
	2 to 3 meters	089443	089443B	

PRINTED LINERS FOR STAIRS

Steps		Printed Liner	Printed Liner + Bands	Diagram
Shape	Widths	Code	Code	
Straight	0 to 2 meters	05794	05794B	
	2 to 3 meters	05795	05795B	
	3 to 4 meters	05796	05796B	
Roman	0 to 2 meters	16169	16169B	
	2 to 3 meters	05801	05801B	
	3 to 4 meters	05802	05802B	
Right angle	0 to 2 meters	05806	05806B	
	2 to 3 meters	05807	05807B	
¼ Circle	0 to 2 meters	16173	16173B	
	2 to 3 meters	089446	089446B	

CONDITIONS FOR ACCEPTING AN ORDER

Note: The colours shown in the catalogue are approximate

Order:

All orders or enquiries for modifying orders must be made in writing.

For avoiding any delay, the client, at his own risk, must forward the supplier all the necessary liner measurements for executing the work. In case the information supplied by the client is insufficient, he will have to supply the missing information ahead of the manufacturing time.

Implicit data:

If the following information is not supplied in writing with the order, we shall consider the below mentioned data for the liner manufacture:

- * Vertical radii of 15 cm.
- * Horizontal radii of a maximum of 5 cm (in the pool shell only). Hung-type fastening system.
- * The horizontal measurements taken from the pool shell.
- * The depth measurements taken from the lower part of the pool's coping stone to the base of the wall.
- * The diagonal measurements taken of the right angles, not of the radii.

To avoid certain misunderstandings, we suggest you take the following precautions:

For holding the liner:

- * Specify the type (hung, overlap or V-fasteners); we anticipate that an additional 15 cm of material will be required for the walls if the overlap fastening system is used.

For steps:

- * Check whether the angles between the step tread and rise (flat and vertical step surfaces) are truly rectilinear.
- * Installation of a discharge nozzle in the middle of the first step is highly recommended for holding the liner in place.
 - * At least 30 cm of water should be left in the pool for maintaining the first step.
- * Avoid designing staircases having more than 5 steps.
- * To confirm dimensions, give the lengths of each step.
- * Check the verticality of pool walls. In case of deficient plumbness, enquire about the order viability.
- * Compound inclination safety ledges should be avoided on the liner.

Taking measurements:

Provide the total lengths and widths.

- * All heights of the pool shell.
- * Width of the safety step on each side.
- * Specify the peripheral size of each side.
- * Provide the measurements of each corner and slope.
- * All dimensions should be provided with horizontal and/or vertical measurements.

If angles are not straight:

- * Measure all of the diagonals from a single point.
- * The diagonals of the right angles are only required for irregular shaped pools without right angles.

Calculation of arcs of circles:

- * The arcs of circles are calculated by their radius.
- * If the radius has not been calculated, a template must be used or the triangulation must be calculated to specify it.
- * Ellipses are calculated using templates (or a grid plan made at intervals of approximately 1 m).

Sectional views:

- * Three views are recommended: a top view, a front view and a side view.

Templates:

- * Make templates for the sky and water sides (or one view).
- * Templates are made for the pool's shell or cover.

Shuttering:

- * Specify the measurements of the shuttering as shown in the diagram.
- * Check that the inside vertical angles of the shutterings are straight.
- * Check that vertical pool shell angles shuttering are in a straight line.
- * Check that the horizontal angle of the wall and shuttering are in a straight line.

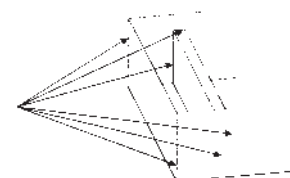
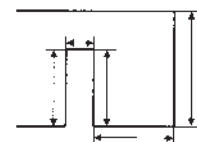
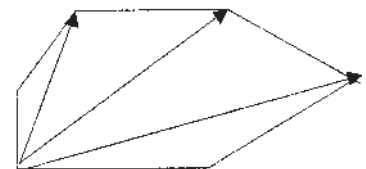



5 x 5

Code	Standard Pack	Standard weight in kg	Standard volume in m ³
------	---------------	-----------------------	-----------------------------------

31 x 31 cm / 13.15" x 13.15"

Niebla azul	NIAZ50Y NIEBLA	-	-
Niebla fuerte	NIFU50Y NIEBLA	-	-
Niebla piscina	NIP150Y NIEBLA	-	-
Niebla menta	NIME50Y NIEBLA	-	-
Blanco	BNCO50Y LISO	-	-
503	050350Y NIEBLA	-	-



NIEBLA AZUL

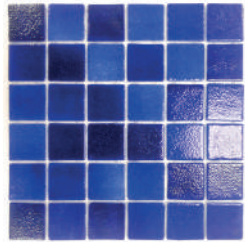

NIEBLA FUERTE



NIEBLA PISCINA



NIEBLA MENTA



BLANCO



503

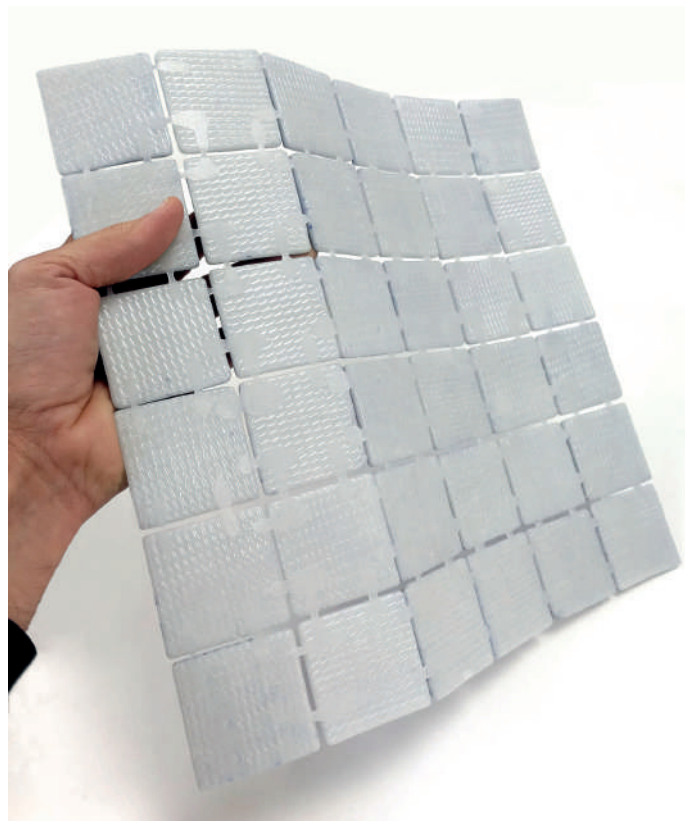

Does not invade the joints

Resistance

Flexibility

Excellent Grip

Durability

Easy intallation



5 x 5

	Code	Standard Pack	Standard weight in kg	Standard volume in m ³
31 x 31 cm / 13.15" x 13.15"				
Niebla Tikal	NIVT50Y NIEBLA			
Niebla Koh Pai	NIKO50Y NIEBLA			
Niebla Bacan	NIBA50Y NIEBLA			
Niebla Java	NIJA50Y NIEBLA			
G326	G32650Y NIEBLA GLOSSY			
G340	G34050Y NIEBLA GLOSSY			
G341	G34150Y NIEBLA GLOSSY			
G342	G34250Y NIEBLA GLOSSY			
Niebla Tikal Silk	NIVT50AY NIEBLA ANTIDESLIZANTE			
Niebla Koh Pai Silk	NIKO50AY NIEBLA ANTIDESLIZANTE			
Niebla Bacan Silk	NIBA50AY NIEBLA ANTIDESLIZANTE			
Niebla Java Silk	NIJA50AY NIEBLA ANTIDESLIZANTE			
Chukum Silk	CHUK50AY NIEBLA ANTIDESLIZANTE			
Batur Silk	BATU50AY NIEBLA ANTIDESLIZANTE			



Niebla Tikal



G326

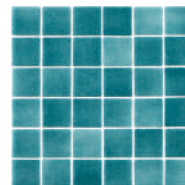

Niebla Tikal Silk



Niebla Koh Pai

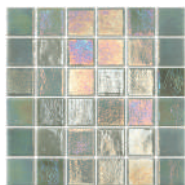

G340



Niebla Koh Pai Silk



Niebla Bacan

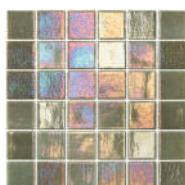

G341



Niebla Bacan Silk



Niebla Java

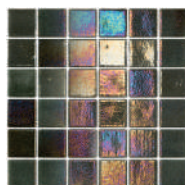

G342

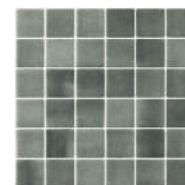

Niebla Java Silk



Chukum Silk



Batur Silk

Pearl

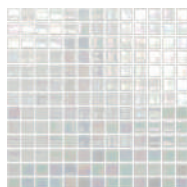

Mod. 1 - 54160

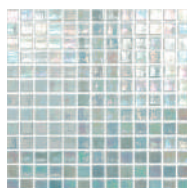

Mod. 2 - 57371

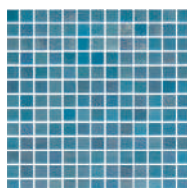

Mod. 3 - 62312

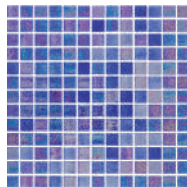

Mod. 4 - 67497

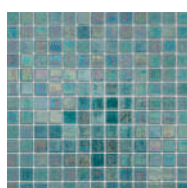

Mod. 5 - 67498

	Code	Standard Pack	Standard weight in kg	Standard volume in m ³
Pearl model 1	54160	-	-	-
Pearl model 2	57371	-	-	-
Pearl model 3	62312	-	-	-
Pearl model 4	67497	-	-	-
Pearl model 5	67498	-	-	-



54160

Blue mix

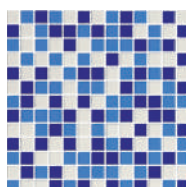

Mod. 1 - 54357

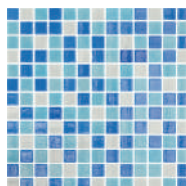

Mod. 2 - 61291

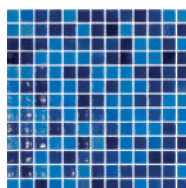

Mod. 3 - 54417

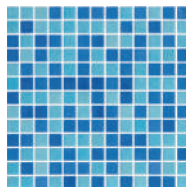

Mod. 4 - 54372

	Code	Standard Pack	Standard weight in kg	Standard volume in m ³
Blue mix model 1	54357	-	-	-
Blue mix model 2	61291	-	-	-
Blue mix model 3	54417	-	-	-
Blue mix model 4	54372	-	-	-



54372

Lagoon effect

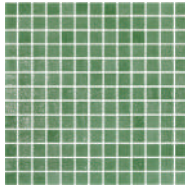

Mod. 1 - 54314

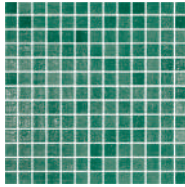

Mod. 2 - 54313

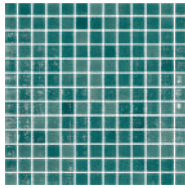

Mod. 3 - 54312

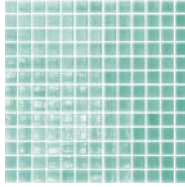

Mod. 4 - 63141

	Code	Standard Pack	Standard weight in kg	Standard volume in m ³
Lagoon effect model 1	54314	-	-	-
Lagoon effect model 2	54313	-	-	-
Lagoon effect model 3	54312	-	-	-
Lagoon effect model 4	63141	-	-	-



Beach effect

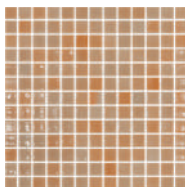

Mod. 1 - 54316

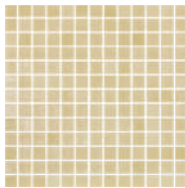

Mod. 2 - 54324

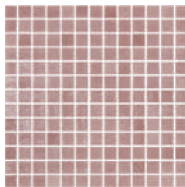

Mod. 3 - 54315

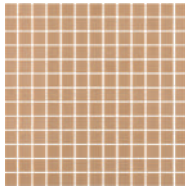

Mod. 4 - 64359
(Matt - C3)

	Code	Standard Pack	Standard weight in kg	Standard volume in m ³
Beach effect model 1	54316	-	-	-
Beach effect model 2	54324	-	-	-
Beach effect model 3	54315	-	-	-
Beach effect model 4	64359	-	-	-

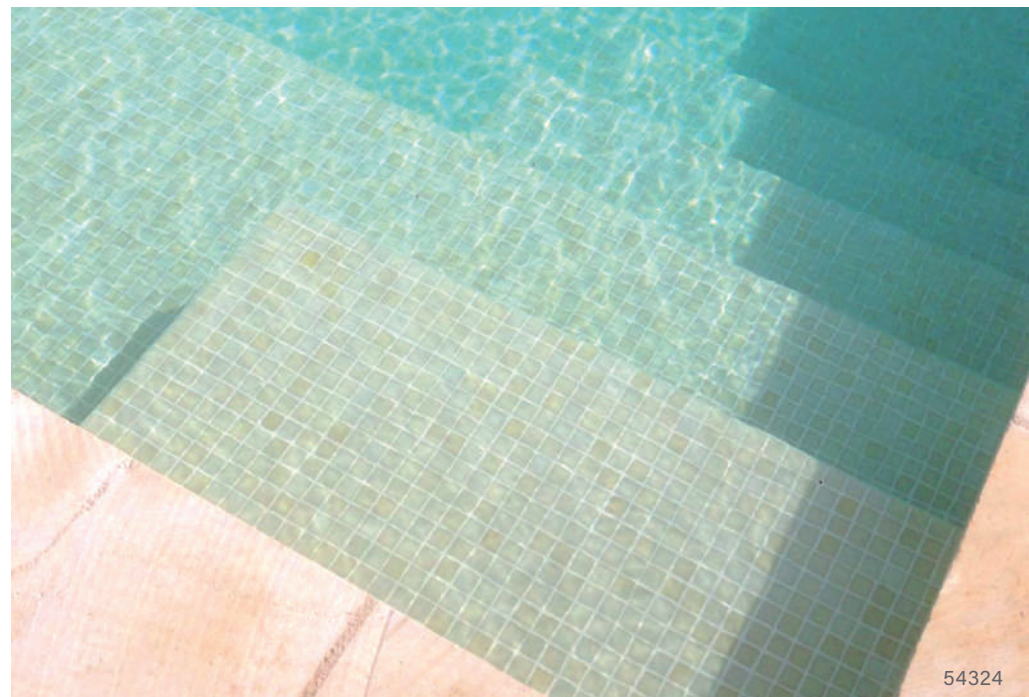

Stone effect

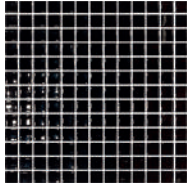

Mod. 1 - 54398

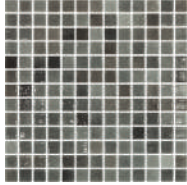

Mod. 2 - 54328



Mod. 3 - 54344

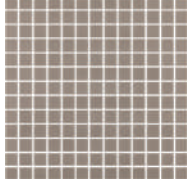

Mod. 4 - 54231
(Matt - C3)

	Code	Standard Pack	Standard weight in kg	Standard volume in m ³
Stone effect model 1	54398	-	-	-
Stone effect model 2	54328	-	-	-
Stone effect model 3	54344	-	-	-
Stone effect model 4	54231	-	-	-



White

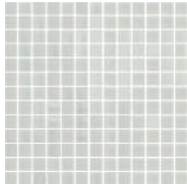

Mod. 1 - 60020



Mod. 2 - 54369

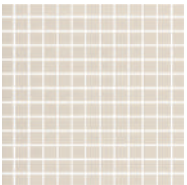

Mod. 3 - 54256
(Matt - C3)

	Code	Standard Pack	Standard weight in kg	Standard volume in m ³
White model 1	60020	-	-	-
White model 2	54369	-	-	-
White model 3	54256	-	-	-



Anti-slip

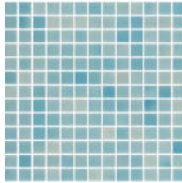

Mod. 1 - 54282
(Matt - C3)

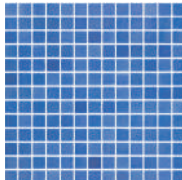

Mod. 2 - 54278
(Matt - C3)

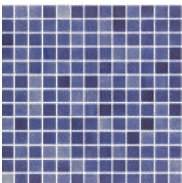

Mod. 3 - 54279
(Matt - C3)



	Code	Standard Pack	Standard weight in kg	Standard volume in m ³
Anti-slip model 1	54282	-	-	-
Anti-slip model 2	54278	-	-	-
Anti-slip model 3	54279	-	-	-

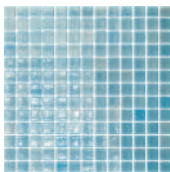

Mod. 1 - 54403

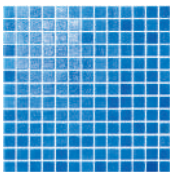

Mod. 2 - 54399

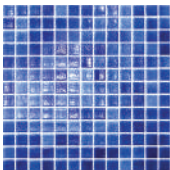

Mod. 3 - 54400

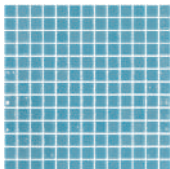

Mod. 4 - 54365

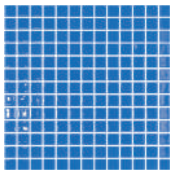

Mod. 5 - 54364

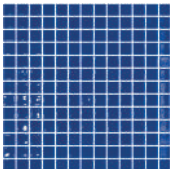

Mod. 6 - 54363

Blue

	Code	Standard Pack	Standard weight in kg	Standard volume in m ³
Blue model 1	54403	-	-	-
Blue model 2	54399	-	-	-
Blue model 3	54400	-	-	-
Blue model 4	54365	-	-	-
Blue model 5	54364	-	-	-
Blue model 6	54363	-	-	-



Premium Pearl Finish Mix

	Code	Standard Pack	Standard weight in kg	Standard volume in m ³
33.4 x 33.4 cm / 13.15" x 13.15"				
Tokyo	TOKY25Y	-	-	-
Montreal	MONT25Y	-	-	-
Paris	PARI25Y	-	-	-
Milan	MILA25Y	-	-	-
Sydney	SYDN25Y	-	-	-
Boston	BOST25Y	-	-	-
Durban	DURB25Y	-	-	-

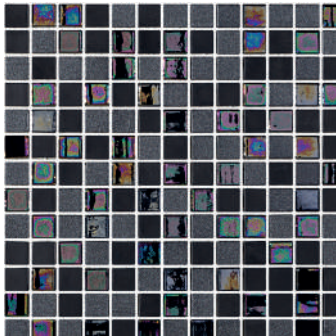

TOKYO

TOKIO

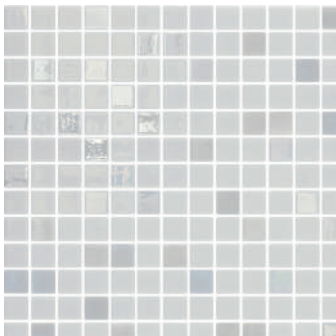

MONTREAL

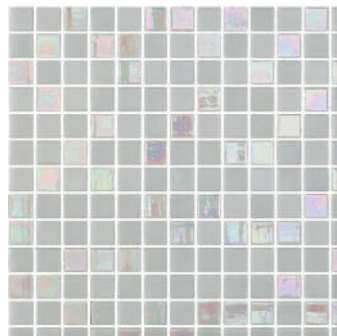

PARIS

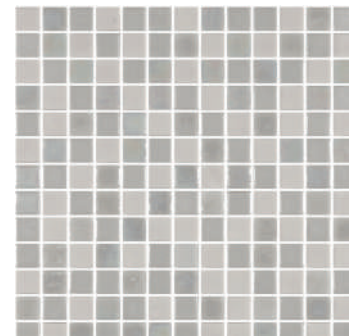

MILAN



SYDNEY



BOSTON



DURBAN

33% MA33 / 33% MT05 / 33% G312

80% BLANCO / 20% G305

33% G305 / 33% MT04 / 33% NIEBLA BLANCO

33% MA35 / 33% MT07 / 33% G329

33% NIEBLA BLANCO / 33% MT01 / 33% G328

33% MT01 / 33% G311 / 33% BLANCO

33% MA34 / 33% MT08 / 33% G330

Premium Pearl Finish Mix

	Code	Standard Pack	Standard weight in kg	Standard volume in m ³
33.4 x 33.4 cm / 13.15" x 13.15"				
Baltic	BALT25Y	-	-	-
Adriatic	ADRI25Y	-	-	-
Artic	ARTI25Y	-	-	-
Pacific	PACI25Y	-	-	-
Indico	INDI25Y	-	-	-
Bali	BALI25Y	-	-	-
Bahamas	BAHA25Y	-	-	-
Murano	MURA25Y	-	-	-
Bahia	BAHI25Y	-	-	-
Martinique	MART25Y	-	-	-

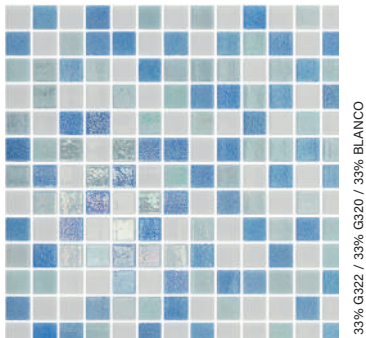

33% G322 / 33% G320 / 33% BLANCO

BALTIC

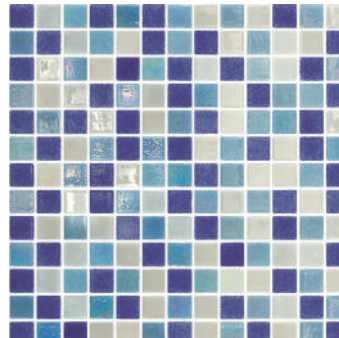

33% G322 / 33% G305 / 33% NIEBLA FUERTE

ADRIATIC

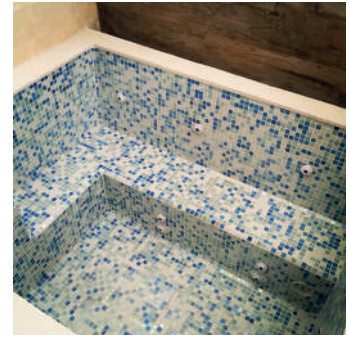

BALTIC

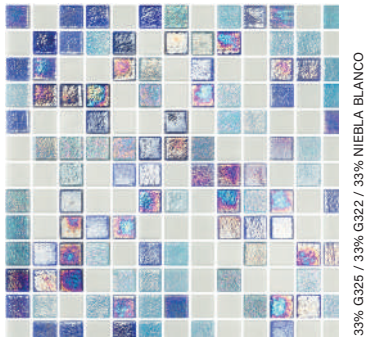

33% G325 / 33% G322 / 33% NIEBLA BLANCO

ARTIC

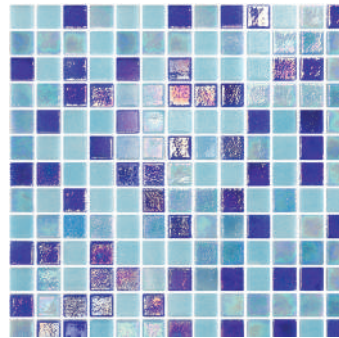

33% G325 / 33% G322 / 33% NIEBLA PISCINA

PACIFIC

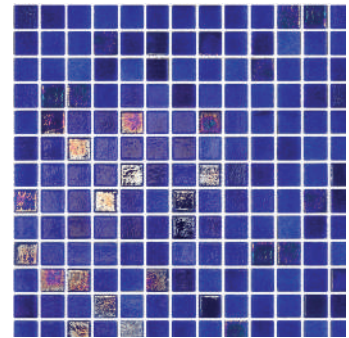

20% G325 / 80% NIEBLA FUERTE

INDICO

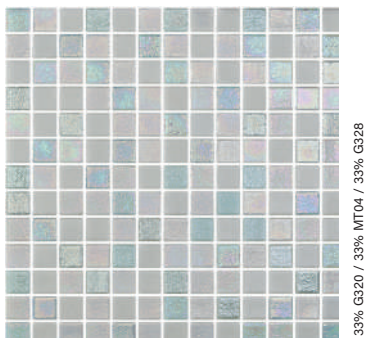

33% G320 / 33% MT04 / 33% G328

BALI



33% G320 / 33% G305 / 33% NIEBLA MENTA

BAHAMAS

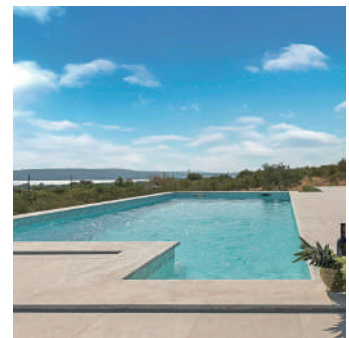

BAHAMAS



80% 202 / 20% G326

MURANO

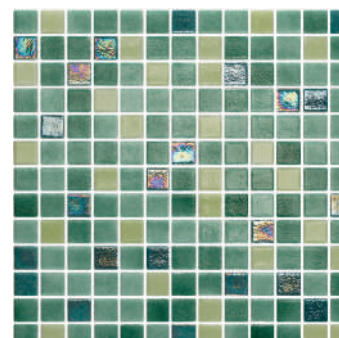

60% 203 / 20% G326 / 20% 211

BAHIA



20% G320 / 80% NIEBLA MENTA

MARTINIQUE

Sixties

Sixties

Code	Standard Pack	Standard weight in kg	Standard volume in m ³
------	---------------	-----------------------	-----------------------------------

32 x 29 cm / 12,60" x 11,42"

White	WHIT60Y	-	-
Grey	GREY60Y	-	-
Turquoise	TURQ60Y	-	-
Blue	BLUE60Y	-	-



WHITE

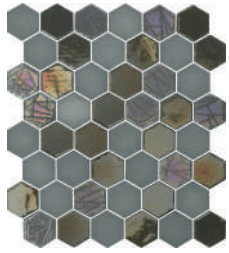

GREY



TURQUOISE

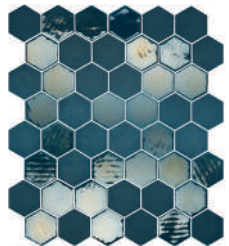

BLUE

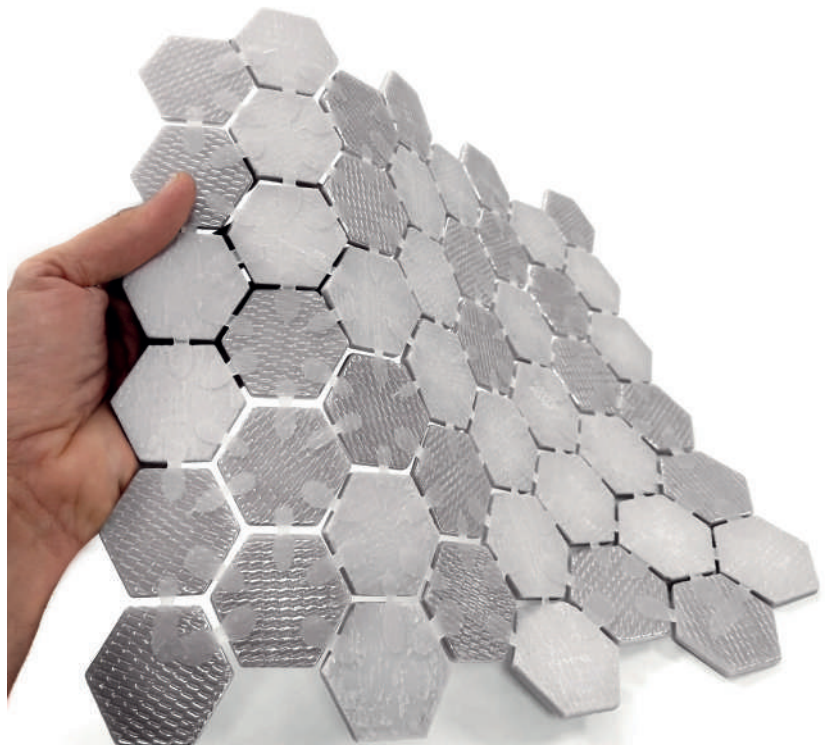
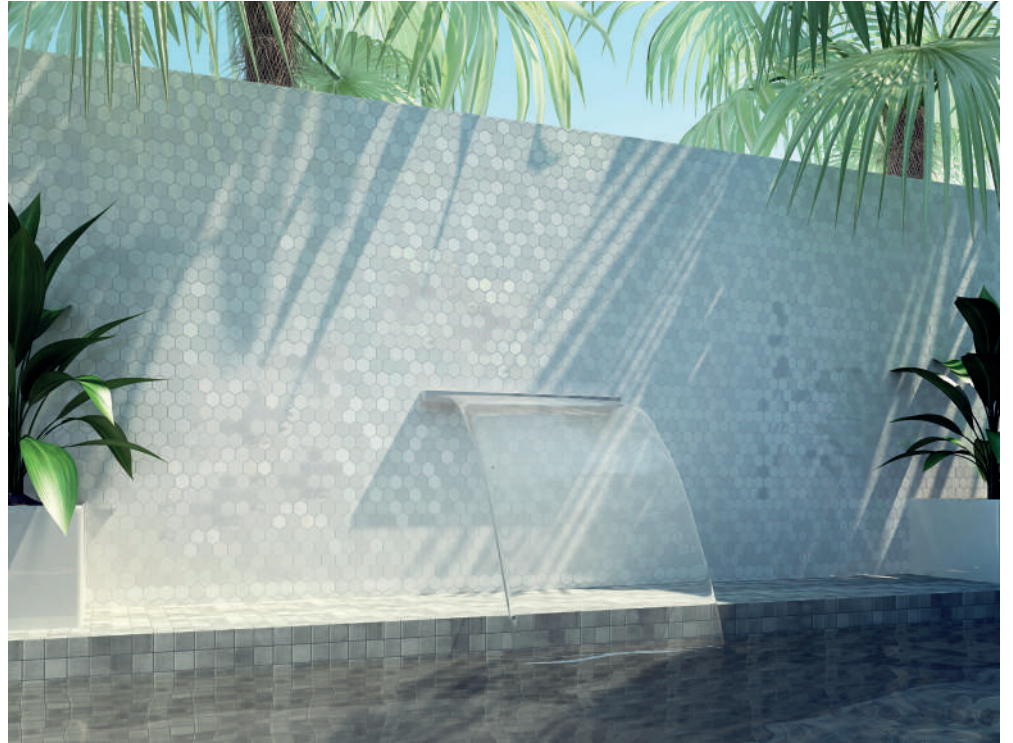

Customized projects

We create drawings and designs in the shapes and colours of your choice. The limits are in your imagination!



Customized projects

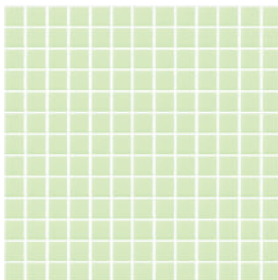

BLUE

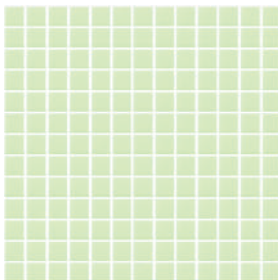

GREEN

Luminescent

Our luminescent mosaic is ideal for signage. It shines in the dark!

	Code	Standard Pack	Standard weight in kg	Standard volume in m ³
33,4 x 33,4 cm / 13,15" x 13,15"				
Blue	LU0125Y2	-	-	-
Green	LU0225Y2	-	-	-

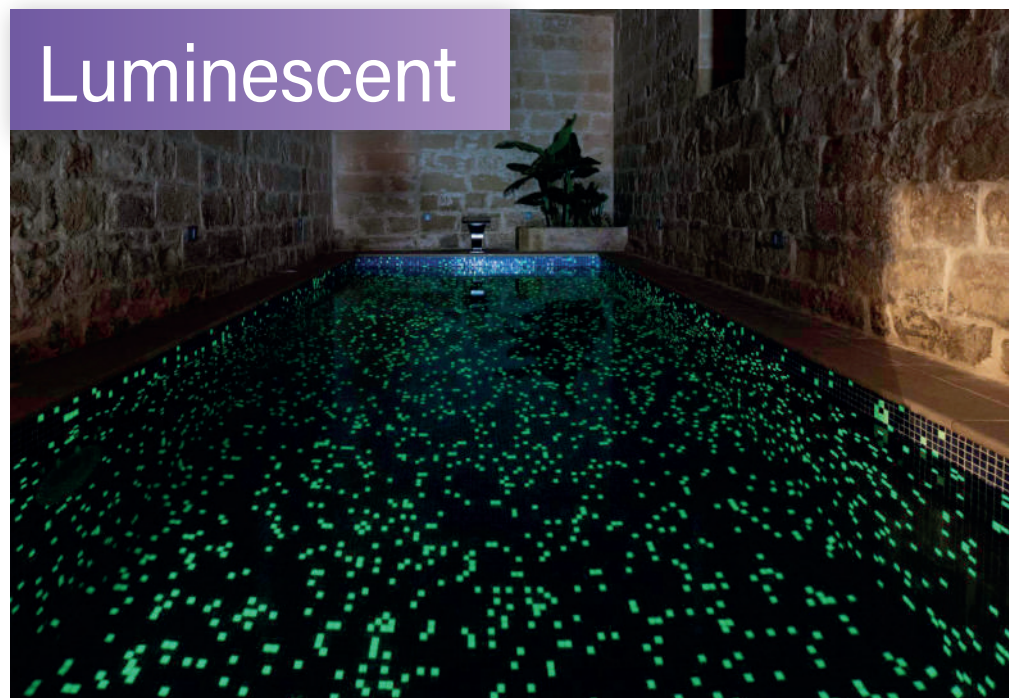

Luminescent

+ PLAIN / FOG / TOGAMA MIX / MATT - NON-SLIP / PEARL / LUMINESCENT/DRAWINGS*
PACKING LIST

Packaging list	Dimensions/Plate	m ² / Box	Kg / Box	Box / Pallet	m ² / Pallet	Kg / Pallet
2.5 x 2.5 cm	33.4 x 33.4 cm	2	18	72	144	1306
5 x 5 cm	30.7 x 30.7 cm	2	22	54	108	1198
Sixties	32.5 x 29.4 cm	1	11	54	54	604

TECHNICAL SPECIFICATIONS

Standard	Description of standard	Plain	Fog	Non-slip matt	Pearl
UNE-EN 10545-3:1997	Water absorption	< 0,10%	< 0,10%		< 0,10%
UNE-EN 10545-12:1997	Scratch resistance	Resistant	Resistant	Resistant	Resistant
UNE-EN 10545-13:1997	Chemical resistance	UA/ULA/UHA	UA/ULA/UHA	UA/ULA/UHA	UA/ULA/UHA
UNE-EN 10545-14:1998	Stain resistance	Class 5	Class 5		Class 5
UNE 67-101:1985+1M:92	Mohs scale resistance to surface scratching	4	4	7	5
UNE-ENV 12633:2003 ANNEX A	Resistance to slipping (Pendulum)			Class 3	
DIN 51130:2010 Section 5	Critical angle of displacement (ramp)			R11	
DIN 51097:1992	Critical slip angle in wet areas where people walk barefoot			Class C	
ISO/DIS 10545-17:1998 ANNEX A	Dynamic friction coefficient (Tortus)			Excellent	

Recycled product - Sustainable product

ENVIRONMENTAL PRODUCT SELF-DECLARATION PURSUANT TO UNE-EN ISO 14021
1 m² of glass mosaic tiling (including mesh)

Total solid content (kg/m ²)	9.97
Content of solid virgin matter	1.25
Minimum content of after-consumption recycled material (kg/m ²)	8.72
MINIMUM CONTENT OF RECYCLED MATERIAL (%) [X = A / A.P.100]	87.4

Finishes - Polyurethane knit



UNNION
 POLYURETHANE SYSTEM

 Resistance

 Durability

 Does not get into joints

 Flexibility

 Easy to place

 Excellent grip

MADE IN SPAIN



87 %

* The borders and patterns are on paper. (Once applied to the mosaic tiling the paper must be removed).

Hydronet



DESCRIPTION

Is a cementitious , single component mortar that protects and waterproofs all types of brick, concrete and mortar joints from water and humidity. Formulated with hydraulic cements and modified with polymers. Resistant to freeze-thaw cycles and to contact with chlorinated water. Membrane suitable for contact with drinking water.

Sealing product suitable for pools made with Mosaic or ceramic and liner.

TECHNICAL SPECIFICATIONS

Code	Description	Contents (kg/pack)	Color	Density (g/cm ³)
65059	Hidronet	25	Grey	1.3

UNDER WATER REPARATIONS SOLUTIONS

SB-Pool Sealer



DESCRIPTION

Chemical product specially formulated to seal leaks or leaks from swimming pools, spas, hot tubs, wells, cisterns, pipes, etc.

	Code	Standard Pack	Standard weight in kg	Standard volume in m ³
SB-Pool Sealer	74725	-	-	-

SB-Pool Super40



DESCRIPTION

Two-component adhesive, structural, flexible and fast that bonds most materials. Bonds, repairs and seals under all conditions, even underwater. Really easy to use.

	Code	Standard Pack	Standard weight in kg	Standard volume in m ³
SB-Pool Super40	72876	12	0.101	0.0120

SB-Pool Superplast Light



DESCRIPTION

Adhesive putty of high mechanical properties, filled inside of an innovative flexible mono-use packaging system for several components. Bonds, repairs and seals under all conditions, even underwater. Really easy to use.

	Code	Standard Pack	Standard weight in kg	Standard volume in m ³
SB-Pool Superplast Light	72877	10	0.027	0.0002

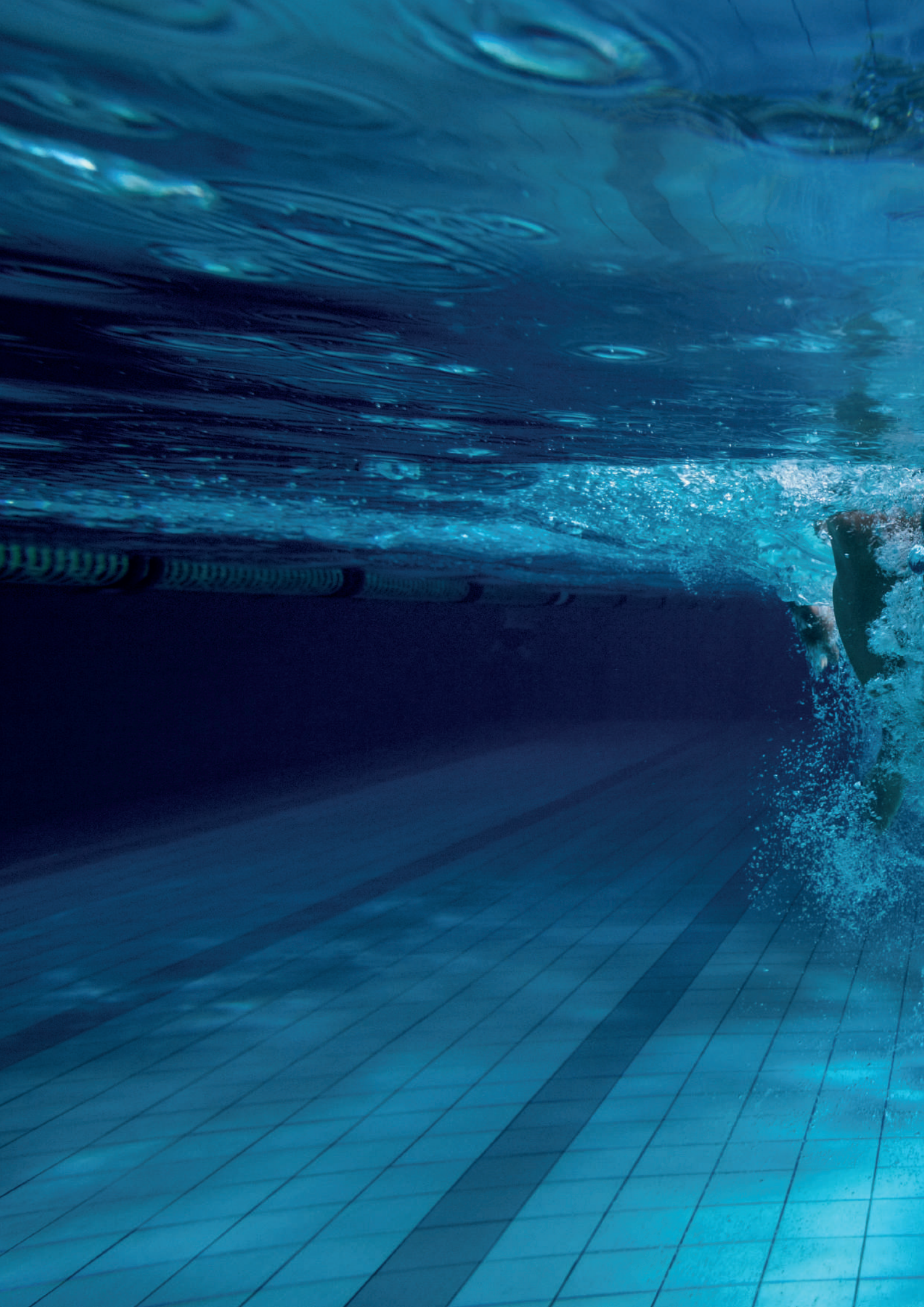

COVERS AND ROLLERS



379 THERMAL AND PROTECTIVE COVERS







- 379 Thermal covers - Bubble
- 380 Premium thermal covers for summer
- 382 Thermal covers - Foam
- 383 Protection covers for winter
- 384 Pool cover accessories
- 385 Reinforced PVC protection covers
- 386 Storage rollers for covers

390 AUTOMATIC COVERS

- 390 General information
- 392 Above-ground models
- 394 Submerged models
- 404 PVC slats
- 406 Step slats
- 408 Polycarbonate slats and steps
- 410 Accessories
- 413 Wireless remote control with key

Comparison

MODELS COMPARISON

	Above-ground		In-ground			
	Octeo	Carlit SOLAR	Dry decking		In-ground decking	
			Roussillon motor in dry pit	Roussillon Motor in the shaft	Roussillon Motor in dry pit	Roussillon Motor in the shaft
						
Maximum dimensions (m)	7.5 x 17	12 x 6	20 x 11	12 x 8	Consult	Consult
Power	Supply	Solar	Supply	Supply	Supply	Supply
Warranty (motor and distribution board)	5 years	5 years	5 years	4 years	5 years	4 years
Safety (NFP 90-308 compliant)	✓✓✓✓	✓✓✓✓	✓✓✓✓	✓✓✓✓	✓✓✓✓	✓✓✓✓
Energy savings	✓✓✓✓	✓✓✓✓	✓✓✓✓	✓✓✓✓	✓✓✓✓	✓✓✓✓
User-friendly	✓✓✓✓	✓✓✓✓	✓✓✓✓	✓✓✓✓	✓✓✓✓	✓✓✓✓
Stylish	✓✓✓	✓✓	✓✓✓✓	✓✓✓✓	✓✓✓✓	✓✓✓✓
Installation in existing pool	✓✓✓✓	✓✓✓✓	✓✓	✓✓	✓✓	✓✓
Installation in new-build pool	✓✓✓✓	✓✓✓✓	✓✓✓✓	✓✓✓✓	✓✓✓✓	✓✓✓✓
PVC slats can be fitted	✓✓✓✓	✓✓✓✓	✓✓✓✓	✓✓✓✓	✓✓✓✓	✓✓✓✓
Polycarbonate slats can be fitted			✓✓✓✓	✓✓✓✓	✓✓✓✓	✓✓✓✓

* Only motor

Thermal covers - Bubble

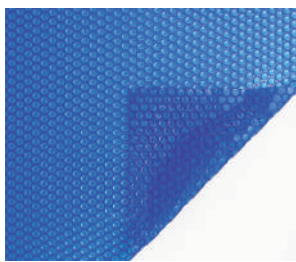

Blue-blue bubble

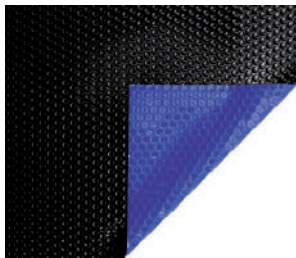

Blue-black bubble

Accessories appear on page 384 of the catalogue

Floating Isothermal "Bubble" covers



DESCRIPTION

- **Composition:** Polyethylene-based material.
- **Joint:** Ultrasonic welding.
- **Edges:** Sewn polyethylene trims.
- **NB model:** Cut only - no trim.
- **Eco model:** Trimmed on both width sides
- **Deluxe model:** Perimeter trim.
- **Fastening:** Eyelets at either end on primary width side.
Eyelets approx. every 65 cm on secondary width side.
- **Composition:** Nickel-plated brass eyelet.
- **Packaging:** Supplied in a cardboard box with a protective cover and instruction handbook.
- **Thickness:** 400 µm.

Model	Pool Type	Code	Standard Pack	Standard weight in kg	Standard volume in m ³
NB Blue	Standard	09296	-	-	-
DUO Blue	Standard	09294	-	-	-
DUO Blue	Freeform	06214	-	-	-
Luxe Blue	Standard	09295	-	-	-
Luxe Blue	Freeform	03975	-	-	-
Deluxe Blue-Black	Standard	16185	-	-	-
Deluxe Blue-Black	Freeform	11483	-	-	-



NB



DUO



Luxe

Steps and accessories

bubble models



	Code	Standard Pack	Standard weight in kg	Standard volume in m ³
Straight stairs fixed price	06215	-	-	-
Roman stairs fixed price	06217	-	-	-
Other stairs fixed price	06218	-	-	-
Special cut pieces for stairs	03976	-	-	-
Additional nickel-plated brass eyelet	04001	-	-	-

Premium thermal covers for summer

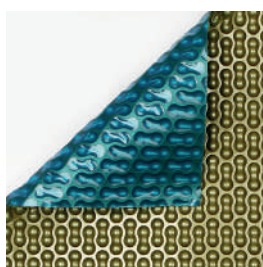
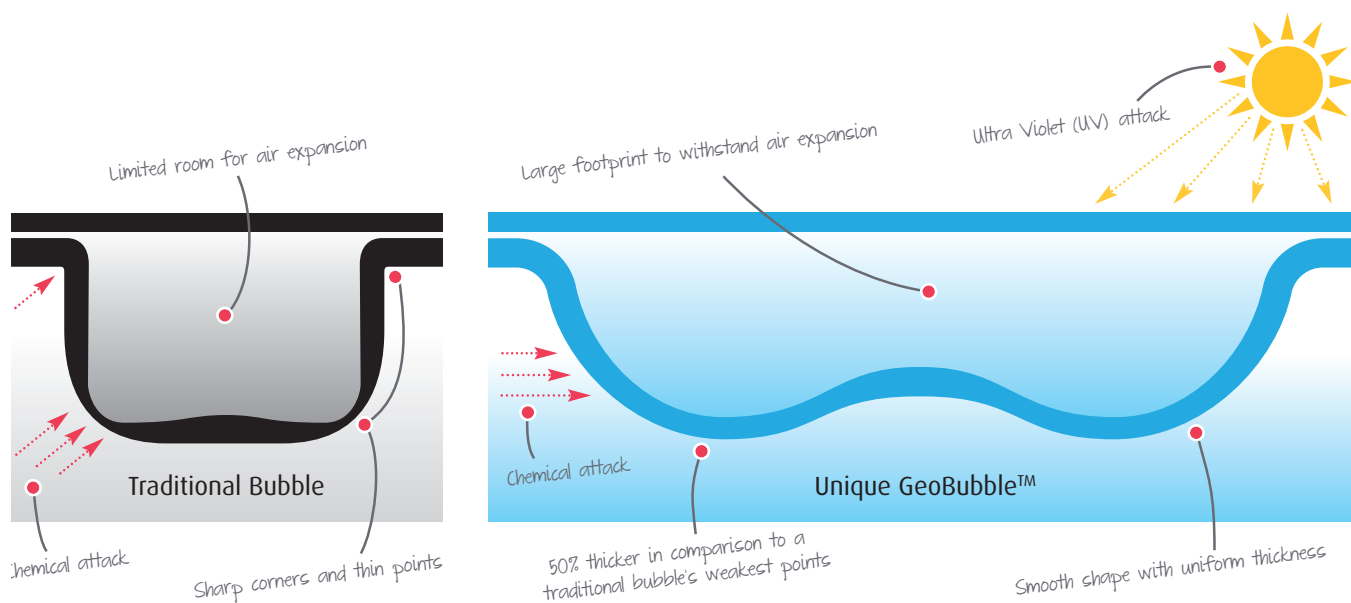

Accessories appear on page 384 of the catalogue

GeoBubble 500 µm model

Dark blue/Gold



	Code	Standard Pack	Standard weight in kg	Standard volume in m ³
Pool type: Standard shape				
Without border	075549	-	-	-
Duo	075552	-	-	-
Luxe	075555	-	-	-
Pool type: Non-Standard shape				
Without border	075550	-	-	-
Duo	075553	-	-	-
Luxe	075556	-	-	-
Pool type: Freeform				
Without border	075551	-	-	-
Duo	075554	-	-	-
Luxe	075557	-	-	-

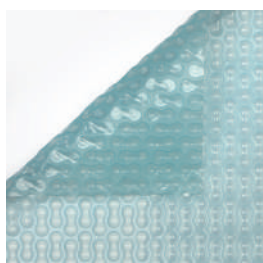

GeoBubble 500 µm model

Sun+Guard



	Code	Standard Pack	Standard weight in kg	Standard volume in m ³
Pool type: Standard shape				
Without border	075558	-	-	-
Duo	075561	-	-	-
Luxe	075536	-	-	-
Pool type: Non-Standard shape				
Without border	075559	-	-	-
Duo	075562	-	-	-
Luxe	075537	-	-	-
Pool type: Freeform				
Without border	075560	-	-	-
Duo	075563	-	-	-
Luxe	075538	-	-	-

Premium thermal covers for summer

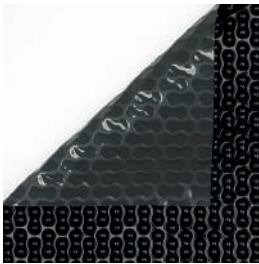

GeoBubble 500 µm model

EnergyGuard



Accessories appear on page 384 of the catalogue

	Code	Standard Pack	Standard weight in kg	Standard volume in m ³
Pool type: Standard shape				
Without border	075564	-	-	-
Duo	075567	-	-	-
Luxe	075570	-	-	-
Pool type: Non-Standard shape				
Without border	075565	-	-	-
Duo	075568	-	-	-
Luxe	075571	-	-	-
Pool type: Freeform				
Without border	075566	-	-	-
Duo	075569	-	-	-
Luxe	075572	-	-	-

Standard shapes

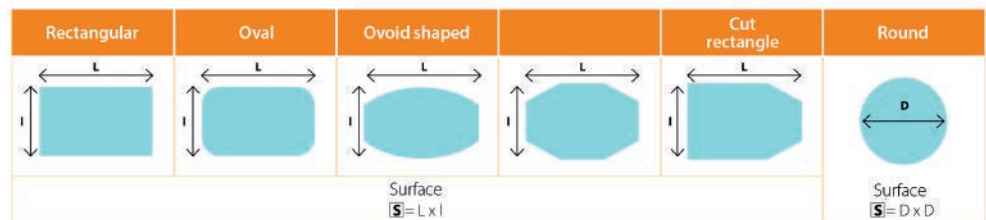

Non-Standard shapes

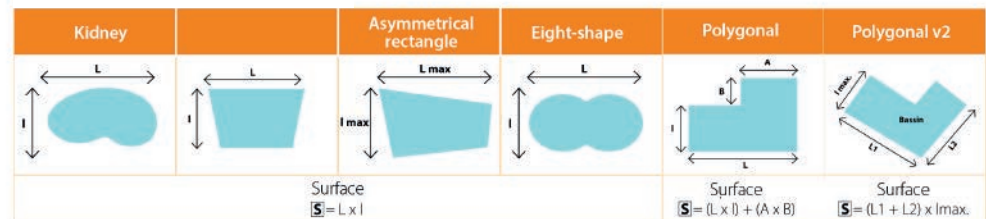

Freeforms

- Any non-standard shape requiring a template for manufacture will be considered free-form.
- Describes the basin shape in a rectangle; L is length and I is height.
- Surface area: $S = L \times I$
- Shapes must be measured correctly for adaption to established templates. If the basin is free-form and standard templates cannot be used, an additional amount will be applied.
- Templates must be checked in-factory and with the lines perfectly visible in order to prevent against misinterpretations.

Price calculation

B x Price / m ²
+ Ladder
+ Cut-out
+ Transport
= Total PRICE

Ladders for GeoBubble

500 µm models



	Code	Standard Pack	Standard weight in kg	Standard volume in m ³
Straight stairs	079833	-	-	-
Roman stairs	079834	-	-	-
Other stairs	079835	-	-	-

Thermal covers - Foam

6 mm foam model



FOAM

Classification: Covers are classified as standard, non-standard or free-form, based on the different shapes defined in the catalogue.

Eco models are trimmed on both width sides.

Deluxe models have a perimeter trim.

DESCRIPTION

- **Composition:** Material based on cross-linked polyethylene foam.
- **Joint:** Thermal welding with double-sided polyethylene tape.
- **Edges:** Sewn PVC trim.
- **DUO model:** Trimmed on both width sides
- **Luxe model:** Perimeter trim.
- **Fastening:** Eyelets at either end on primary width side.
Eyelets approx. every 65 cm on secondary width side.
- **Composition:** Nickel-plated brass eyelet.
- **Option:** Polyethylene foam floating reinforcement on width side.
- **Packaging:** Supplied rolled up with a protective cover.
- **Thickness:** 6 mm.

Model	Pool Type	Code	Standard Pack	Standard weight in kg	Standard volume in m ³
DUO Model	Standard	09297	-	-	-
DUO Model	Non-standard	03983	-	-	-
DUO Model	Freeform	03992	-	-	-
Luxe Model	Standard	09298	-	-	-
Luxe Model	Non-standard	03991	-	-	-
Luxe Model	Freeform	03984	-	-	-

Attention: Unless specified in the order, the stair cover is supplied welded to the pool cover, applying the corresponding surcharge.

Steps and various foam models

	Code	Standard Pack	Standard weight in kg	Standard volume in m ³
Straight stairs fixed price	06215M	-	-	-
Roman stairs fixed price	06217M	-	-	-
Other stairs fixed price	06218M	-	-	-
Special cut pieces for stairs	03993	-	-	-
Additional nickel-plated brass eyelet	04001	-	-	-

Protection covers for winter

PVC Intersup opaque model

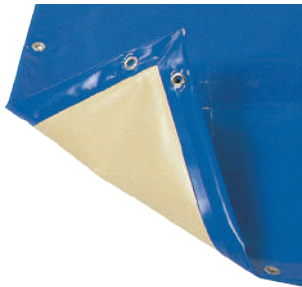

BLUE INTERSUP



BLUE LUXE INTERSUP

INTERSUP ECO COVERS

- **Composition:** 580 g/m² double-sided coated PVC fabric.
- **Joint:** High frequency welding.
- **Borders:** Perimeter fold joined by high frequency weld.
- **Fixing:** Using pairs of nickel-plated brass eyelets
+ Double pressed tensor rubber
+ S.S. anchoring fixture
Distance between rubber tensors = 70 cm
Distance between eyelets = approx. 20 cm.
- **Grille:** Centrally located drainage grid screen in pre-shrunk PVC fabric joined by high frequency welding.
- **Packaging:** Supplied in a cardboard box with an instruction handbook.

INTERSUP DELUXE COVERS

- **Composition:** 580 g/m² double-sided coated PVC fabric.
- **Joint:** High frequency welding.
- **Borders:** Perimeter fold joined by high frequency weld.
- **Fixing:** With straps
+ Dynamometric tensor
+ S.S. anchoring fixture
Separation between tape - approx. 1 m. Overlap - 50 cm.
- **Grille:** Centrally located drainage grid screen in pre-shrunk PVC fabric joined by high frequency weld.
- **Packaging:** Supplied in a cardboard box with an instruction handbook.

Model	Pool Type	Code	Standard Pack	Standard weight in kg	Standard volume in m ³
Blue/Ivory					
Eco Model	Standard	09338	-	-	-
Eco Model	Freeform	06198	-	-	-
Deluxe Model	Standard	09339	-	-	-
Deluxe Model	Freeform	06208	-	-	-
Green/Ivory					
Eco Model	Standard	09526	-	-	-
Eco Model	Freeform	09528	-	-	-
Deluxe Model	Standard	09529	-	-	-
Deluxe Model	Freeform	09531	-	-	-

Steps and others for Intersup models

	Code	Standard Pack	Standard weight in kg	Standard volume in m ³
Straight stairs fixed price	05755	-	-	-
Roman stairs fixed price	05756	-	-	-
Other stairs fixed price	06219	-	-	-
Special cut pieces for stairs	03869	-	-	-
Additional nickel-plated brass eyelet	04001	-	-	-

Pool cover accessories

Accessories



S.S. Spike - 03994



S.S. Spike for lawn - 05732

		Code	Standard Pack	Standard weight in kg	Standard volume in m ³
S.S. Spike	Per unit	03994	-	-	-
S.S. Spike for lawn	Per unit	05732	-	-	-
Retractable cylindrical spike	Per unit	40950	-	-	-
Retractable anchoring, with spring	Per unit	03995	-	-	-
Dynamometric spring	Per unit	03996	-	-	-
1.50 m black strap for roller	Per unit	25980	-	-	-
8 mm rubber tensor	m ²	03998	-	-	-
8 mm x 60 cm Cabiclic rubber tensor	Per unit	03999	-	-	-
Ø 10 x 80 mm rust-proof sheath	Per unit	05736	-	-	-
Complete 2 piece hole cover	Per unit	05734	-	-	-
Fixkit clip with rubber tensor	Per unit	09439	-	-	-



Retractable spike
40950



Concealable anchoring, with
spring - 03995



Roller 1.50 m black strap
25980



8 mm rubber tensor
03998



60 cm Cabiclic rubber tensor
03999



Dynamometric spring
03996



25 cm Cabiclic rubber tensor
05736



Rubber tensor with hooks
05734



Fixkit clip with rubber tensor
09439

Reinforced PVC protection covers

- Safety cover to prevent children under 5 from getting into the pool.
- Compliant with standard NFP 90-308.
- For in-ground pool max. 11 x 5 metres (+ ladder).
- Allow at least 30 cm on each side of the pool (e.g., pool of 10 x 5 metres, cover of 10.60 x 5.60 m).
- Can be used all year round as it protects the pool from dirt in summer and winter and diminishes the proliferation of bacteria and algae.



Tramuntana cover



DESCRIPTION

- **Composition:** 580 g/m² PVC cloth reinforced with aluminium rods approx. every 1.50 m.
- **Joint:** High frequency weld.
- **Edges:** 6 cm double-edge welded along the whole length with anti-lift tapes inside.
- **Reinforcements:** Anti-abrasion PVC slides in each rod at the level of the coping.
- **Fastenings:** Tapes and stainless steel hooks. Cylindrical stainless steel/aluminium stakes.
- **Drainage:** Holes for draining rainwater across the whole width of each rod.
- **Rolling:** 1 or 2 cranks, depending on cover size.
- **Packaging:** Cardboard and instruction handbook.

	Code	Standard Pack	Standard weight in kg	Standard volume in m ³
Blue/Beige	40939	-	-	-
Green/Beige	40940	-	-	-
Almond/Beige	40941	-	-	-
Beige/Beige	40942	-	-	-
Medium grey / beige	099025	-	-	-

Reduction gear crank system



DESCRIPTION

A handle is used for pools smaller than 9 m and two handles for pools bigger than 9 m. The handle fits into one of the rods and will allow the cover to be rolled.

	Code	Standard Pack	Standard weight in kg	Standard volume in m ³
Demultiplication handle	41223	-	-	-

Steps for Tramuntana cover



	Code	Standard Pack	Standard weight in kg	Standard volume in m ³
Fixed price straight steps	40947	-	-	-
Trim for steps	40948	-	-	-
Profile for wide steps	42411	-	-	-

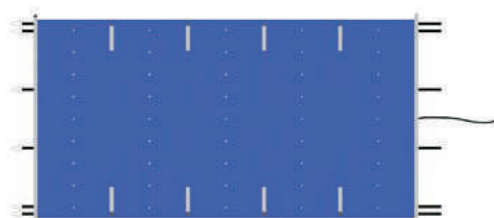

Storage rollers for covers

Central pipe in anodized aluminium

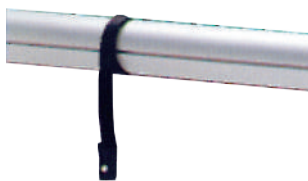

Covers max. length:
15 m

Other lengths, available on
request

	Code	Standard Pack	Standard weight in kg	Standard volume in m ³
Ø 100 mm				
Fixed pipe, length 4.5 m	07622	1	12.0	0.059
Fixed pipe, length 5.5 m	07623	1	14.3	0.071
Fixed pipe, length 6.6 m (2 rubber bands included)	07624	1	17.4	0.084
Telescopic pipe, length 4 - 5.5 m	07625	1	12.8	0.054
Telescopic pipe, length 5 - 6.6 m	07626	1	15.5	0.067
Ø 80 mm				
Telescopic pipe, length 4 - 5.5 m	24762	1	10.3	0.035
Telescopic pipe, length 5 - 6.6 m	30806	1	12.3	0.043

Fixed pipe

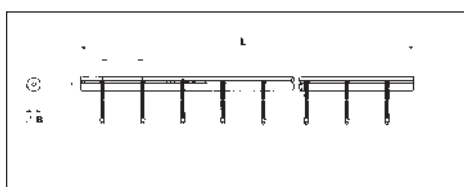

Telescopic pipe

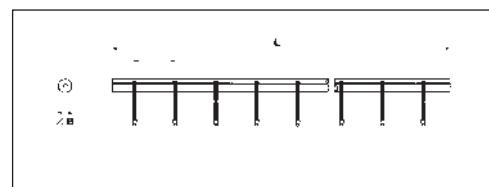

TECHNICAL FEATURES

Pipe code	L (m)	Ø B (mm)	N. straps
07622	4.5	100	8
07623	5.5	100	8
07624	6.6	100	10

TECHNICAL FEATURES

Pipe code	L (m)	Ø B (mm)	N. straps
07625	4.0 - 5.5	95/100	8
07626	5.0 - 6.6	95/100	8
24762	4.0 - 5.5	75/80	8
30806	5.0 - 6.6	75/80	8



Covers max. length:
15 m

Tube shown in the
photo not included in supply

Stainless Steel mobile support



DESCRIPTION

A set of 2 supports, one "T" end fixed support and the other end support with wheels. Includes 8 straps to tie the cover.

	Code	Standard Pack	Standard weight in kg	Standard volume in m ³
Supports in AISI-304	07628	1	7.2	0.035

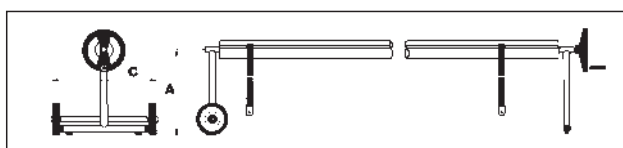

TECHNICAL FEATURES

Code	A (mm)	C (mm)
07628	500	650

Storage rollers for covers

Stainless Steel fixed end brackets



Tube shown in the photo not included in supply

DESCRIPTION

Set of 2 brackets in "T" shape in AISI-304. Includes steering wheel operation with 8 straps for fixing the cover.

	Code	Standard Pack	Standard weight in kg	Standard volume in m ³
A set of 2 "T" brackets	07631	1	4.8	0.035

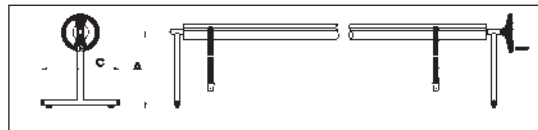

TECHNICAL FEATURES

Code	A (mm)	C (mm)
07631	500	514

Fixed support for roller



Tube shown in the photo not included in supply

DESCRIPTION

Two flange fixing supports with adjustable height from 500-800 mm in AISI-304. Fixed to the floor with flanges. Includes 8 straps for fixing the cover.

	Code	Standard Pack	Standard weight in kg	Standard volume in m ³
A set of 2 "T" brackets	07631	1	4.8	0.035
Supports in AISI-304	07629	1	7.2	0.029

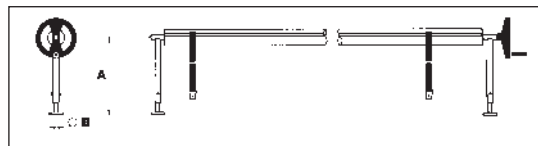

TECHNICAL FEATURES

Code	A (mm)	B (mm)
07629	500 to 800	100

Wall support for roller

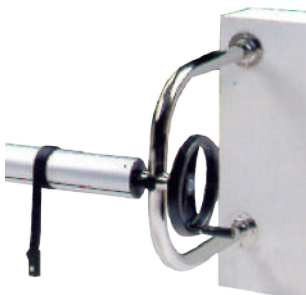

Tube shown in the photo not included in supply

DESCRIPTION

Pair of wall fixing supports. In S.S. AISI-304. Includes 8 straps for fixing the cover.

	Code	Standard Pack	Standard weight in kg	Standard volume in m ³
Supports in AISI-304	07630	1	6.6	0.087

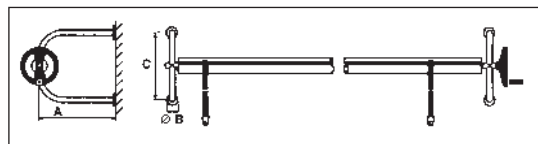

TECHNICAL FEATURES

Code	A (mm)	B (mm)	C (mm)
07630	500	100	500

Storage rollers for covers

Roller supports for larger pools



Tube shown in the photo not included in supply

DESCRIPTION

Suitable for fixed roller pipes 07622, 07623 and 07624 or telescopic pipes 07625 and 07626, with 1, 2 or 3 rollers and steering wheels and rotating bar wheel for handling covers. Contains of 2 Stainless Steel AISI-304 structures with wheels (1 set with brakes) to move the roller. Includes 8 straps per roller.

	Code	Standard Pack	Standard weight in kg	Standard volume in m ³
2 mobile supports with 1 roller pipe	15836	1	36.4	0.937
2 mobile supports with 2 roller pipes	15835	1	27.4	1.46
2 mobile supports with 3 roller pipes	15834	1	28.4	1.46

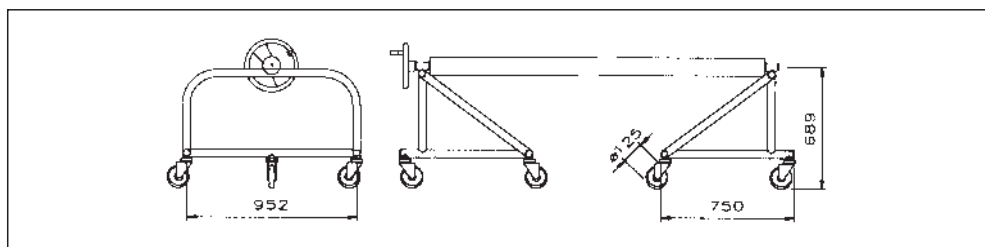

Mobile supports with 1 pipe. - Dimensions in mm.

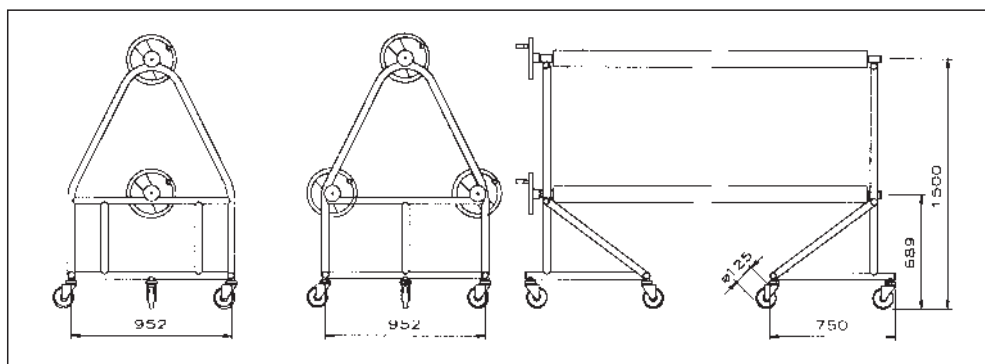

Mobile supports with 2 and 3 roller pipes. - Dimensions in mm.

Storage rollers for covers



Borna municipal model



DESCRIPTION

It is intended to be installed in municipal indoor or outdoor pools of 12.5 x 25 meters maximum. It can be used for bubble or reinforced polyethylene foam covers. The distance between the roller shaft and the pool edges must be reduced as much as possible to prevent abnormal wear and tear due to the friction on the coping.

Technical features:

- 250 Nm 24V motor.
- 300 mm stainless steel shaft.
- Thermoplastic bushing with stainless steel bearing.
- Stand with a protective layer in thermoformed ABS.
- Remote control + Key.

Tube shown in the photo not included in supply

	Code	Standard Pack	Standard weight in kg	Standard volume in m ³
Mechanical kit up to 12.5 m (max. 12.5 x 25 m)	38734	-	-	-



Double municipal model



DESCRIPTION

Makes it possible to cover municipal pools up to 15 x 25 m with bubble or polyethylene foam covers. 6.03 x 25 m.

Technical features:

- 2 x 120 Nm 24V tubular motors.
- 2 aluminium shafts.
- 6 wheels.
- Remote control + Key.

	Code	Standard Pack	Standard weight in kg	Standard volume in m ³
Width ≤6.03m Length ≤ 25m	41441	-	-	-
Width ≤8.03m Length ≤ 25m	41442	-	-	-

General information

The AstralPool automatic cover

AstralPool is continually incorporating the latest innovations to its products in matters of safety. As such the automatic pool covers have been developed to meet the demands of the French standard NF P90 308, which guarantees maximum user safety.

The AstralPool automatic covers cover the whole pool and are easily rolled up or spread thanks to their built-in motorized roller. The turning of a key is all that is needed to get it working.

Manufactured in rigid slats available in various colours, the design and composition produce a floating cover that fits over the entire pool and makes for very effective heat insulation. We have seven models to cover the equipment needs of new and existing pools: the submerged Roussillon models, the above-ground Carlit models and the above-ground model with a bench, Capcir.

Roussillon submerged automatic models allow for seamless integration with the pool. The roller mechanism is located in a separate sunken compartment sectioned off from the pool by a brick or PVC panel.

The above-ground models (Carlit) are ideal for already existing pools as the winding shaft is fastened in place to the pool decking.

The above-ground models with protective casing (Narbonne) are the basic above-ground models which can be complemented with a bench that covers the mechanical installation, giving it a high-quality finish. For installation in existing swimming pools.

Main advantages

- Increased safety in the swimming pool to protect people and pets from falling accidentally into it. The floating slats cover the entire water surface.*
- Very convenient to use, the swimming pool is covered and uncovered in silence by simply turning a key.
- Represents considerable savings:
 - It acts as a thermal barrier preventing heat losses and extending the pool use season.
 - It is a basic complement for pool heating.
 - It prevents evaporation, therefore it saves water.
 - It reduces algae formation, which results in an important saving in chemical products.
- In indoor pools no condensation is produced in the enclosed hall, thus avoiding deterioration of building materials.
- Lower maintenance costs: reduction of suspended particles.
- The automatic cover enables greater customisation of the swimming pool, increasing its value.

AstralPool service

- The wide AstralPool commercial network offers immediate service.
- We offer our clients pre- and post-sales technical assessment.
- The manufacturing technical sheet will be used to make a cover which is perfectly adapted to your needs.
- All AstralPool covers undergo strict quality control based on the most demanding regulations.
- Assembly and Civil Engineering Manuals are available to allow building the swimming pool with the ideal requirements for subsequent installation of the submerged cover.

(*) Our automatic covers comply with the requirements of the French standard NF P90-308 which demands the use of standardized safety mechanisms to prevent the risk of drowning by accidental falls into the pool.

General information

Advice for use and winterizing

We recommend to follow these basic indications to obtain the optimum performance from the automatic cover:

- Before operating the cover you must ensure that nobody is in the swimming pool and that there are no objects that could become obstacles to its normal operation.
- Maintaining the correct water level is also important, as a level which is too high or too low can cause blockages at the tie beam, partition or the steps.
- During the retrieving and expanding operations the cover should not be blocked, as this action could be dangerous as well as harmful to the operating mechanism.
- If an automatic pool floor cleaner is used make sure that when the cover is extended neither the hose nor the power supply cable is caught up.
- Regular cleaning of the cover with a pressure cleaning device or with a PVC descaling liquid is recommended. This will also prevent leaves from settling on the cover which could otherwise stain the slats.
- In the case of a hail storm we recommend that you retrieve the cover.
- In the Roussillon submerged model we recommend that you always keep the motor housing dry to prevent the geared motor from getting wet.

For good winterization, and in order to find the pool in the best conditions in the spring, we recommend to follow the following indications:

- Leave the cover extended over the water surface.
- Keep the water level constant. An excess should be drained through the main drain or the skimmer box.
- It is advisable to clean the trapdoor and the motor housing with a high pressure cleaner before the pool is winterized.
- Place a number of anti-freeze floats in the trapdoor casing, behind the cover. The skimmers should also be protected in the same way.
- We recommend the installation of a plastic type cover to prevent leaves and other substances from obstructing the trapdoor, which should be cleaned regularly.
- In the case of freezing, avoid forcing or pressing down hard on the slats as they could be damaged.
- If the motor is in risk of flooding it is advisable to cut off the power supply and remove the motor.

Automatic cover price calculation

PRICE CALCULATION

How to calculate the price of an above-ground cover

The basic elements to calculate the above-ground cover are:

1. Mechanical kit
2. Slats
3. Ladder
4. Safety system
5. Postage and packaging

How to calculate the price of a submerged cover

The basic elements to calculate the submerged cover are:

1. Mechanical kit
2. Embedding kit
3. Tie beam and brackets
4. Kink-proof bracket (when necessary)
5. Partition and brackets
6. Slats
7. Ladder
8. Safety system
9. Postage and packaging

Automatic covers: Above-ground models

Above-ground models

Zen'it bench

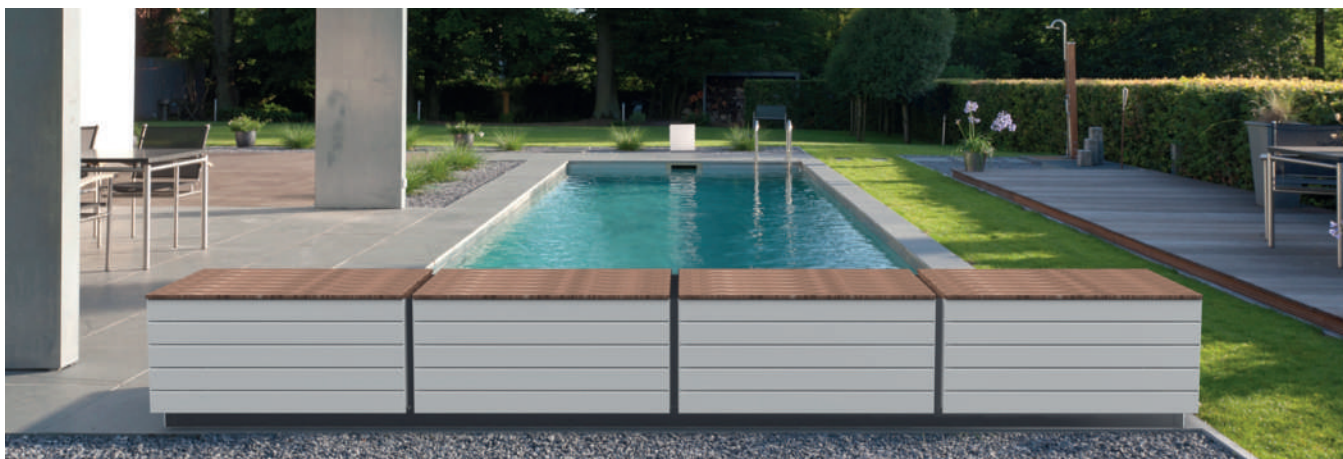

The new AstralPool ZEN'IT bench fits any above-ground automatic covers.

Original 3 in 1: to cover the roller and the stander, to store equipment, to add value to the pool. Bench manufactured with quality materials in powder-coated aluminium, Stainless steel and exotic wood.

Easy-to-mount, in kit. No handling equipment necessary.

Length of 1 module: 1.2 m

Max. Length of the cover: 9 m with special roller stander.

Sold with or without above-ground roller – contact us for more info.

- Trendy design
- Supplied in kits, easy-to-mount
- Multi-purpose

Different finishes available

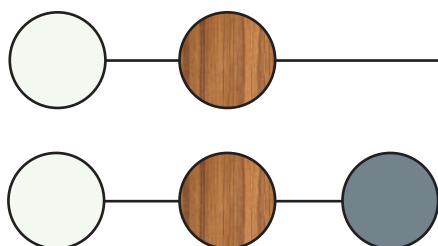

Access to the skimmers and mechanical parts

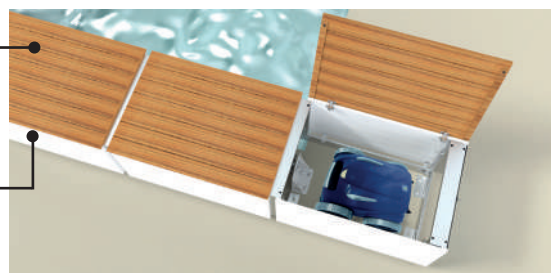

With storage area

Overall dimensions

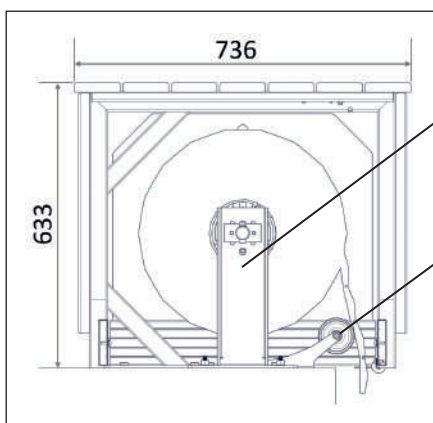

Space saving stander, reducing the footprint of the roller

Guiding system: reduced footprint over the pool

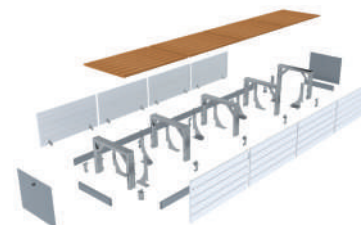

Complete bench shipped on a Euro pallet
Mounting time: 30 min/module
No need for handling equipment

TECHNICAL FEATURES

Number of modules	3	4	5	6
Total bench length	3.56 m	4.77 m	5.97 m	7.17 m
Max pool width	3.01 m	4.22 m	5.42 m	6 m

Above-ground models

Octeo above-ground model



DESCRIPTION

- 4 color combinations to choose from.
- A new model designed in collaboration with a designer: modern shape and outline.
- EXCLUSIVE to AstralPool: Bluetooth receiver integrated in the stand to operate the cover using the APP.
- Cast aluminum structure.
- Easy to assemble and disassemble.
- Motor: Tubular.
- Pool (interior dim.): 7.5 x 17 m
- Motorized roller
 - With limit switch.
 - With salt chlorinator contact.
- Standard cover.
- 4 stand colors available.



White / White BB White / Anthracite Grey BG Anthracite Grey / White GB Anthracite Grey / Anthracite Grey GG

Stand + shaft + motor with limit switch + unit with contact for salt chlorinator + key switch on stand + cover connect APP.

4 stand colors available. Add the 2 letters for the chosen color at the end of the code.

For example, OCTÉO stand in Anthracite Grey / White for an interior pool width of 7.5 m and length of 16 m: Code 072020GB

MAX. POOL INTERIOR WIDTH						
	3.03 m	4.03 m	5.03 m	6.03 m	7.03 m	7.5 m
Max. POOL INT. length	Code	Code	Code	Code	Code	Code
3	072005	072005	072011	072015	072017	072019
4						
5						
6			072012			
7						
8						
9	072006	072008	072013	072018	072020	
10						
11		072014				
12						
13	072010	072016				
14						
15						
16						
17						

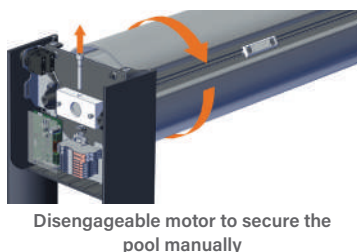

Power cable according to the distance (D) between the motor and the electrical panel		
D < 15 m	15 m < D < 25 m	25 m < D < 50 m
2 x 4 mm ²	2 x 6 mm ²	2 x 10 mm ²

Chlorinator cable
2 x 1,5 mm ²

Pool length	Ø of coil in mm (shaft + blades)
4 m	390
5 m	420
6 m	450
7 m	470
8 m	490
9 m	520
10 m	530
11 m	560
12 m	570
13 m	590
14 m	610
15 m	640
16 m	660
17 m	680

Related products

For users who prefer not to use a smartphone to operate the cover, the combination of the wall control unit or the remote control is a complementary solution:

- Wireless wall-mounted remote control unit + app **070562**
- Keyping remote control not compliant with the NP P90-308 standard **907672**

Submerged models



Roussillon submerged model: dry well motor



DESCRIPTION

The Roussillon automatic cover is the submerged model which incorporates the motor in a separate sunken compartment and both the winding shaft as well as the cover are housed inside the pool at one end. The Roussillon model can cover an indoor pool up to 11 x 20 m.

The submerged pit containing the roller shaft from the main pool should be separated from the main pool by a small concrete partition at the time of construction or with a PVC partition later on.

The basic elements for assembling the cover are the slats, the step slats, the mechanical kit, the embedding kit, the aluminium tie beam and the pit cover.

MECHANICAL KIT

Includes the following elements:

- Extruded aluminium or stainless steel shaft.
- Motor stand.
- Watertight gaskets on bushing side.
- Watertight gaskets on bearing stand side.
- 24V reducer motor with stainless steel stand.
- 220/24V standard switchboard.
- On-off key switch with key. Should be installed in full view of the pool. Works by continuous turning of the key.



Extruded aluminium shaft



On-off key switch

Embedding kit for a standard installation 55 cm above the water level.
Should the shaft have to be installed at a greater height, please consult us.

Solution valid for a mechanical installation up to a maximum depth of 55 cm of the water level. For greater depths, please enquire.

ROUSSILLON WITH MOTOR IN DRY PIT

0 < Axis depth below water level ≤ 0.55 m	Maxi WIDTH inside pool						
	3.03 M	3.53	4.03	4.53	5.03	5.53	6.03
MAXI Length inside pool (total with the pit)	Code FIF	Code FIF	Code FIF	Code FIF	Code FIF	Code FIF	Code FIF
4	060465ET	060465ET	060465ET	060467ET	060467	060468ET	060468ET
5							
6							
7							
8							
9							
10							
11							
12							
13							
14	071601	071601	071602	071602	071602	070442	
15							
16							
17							
18							
19							
20	061011ET	061011ET	061011ET	070442			

Submerged models

Roussillon submerged model: dry well motor



310 mm wall conduit



Bearing bracket for recessed assemblies

EMBEDDING KIT

Includes the following elements:

- Bushing.
- Bearing support bracket for embedding.
- Watertight gaskets for bushing.

	Code	Standard Pack	Standard weight in kg	Standard volume in m ³
Embedding kit				
With 110 mm wall conduit	33075	-	-	-
With 210 mm wall conduit	31143	-	-	-
With 310 mm wall conduit	33074	-	-	-

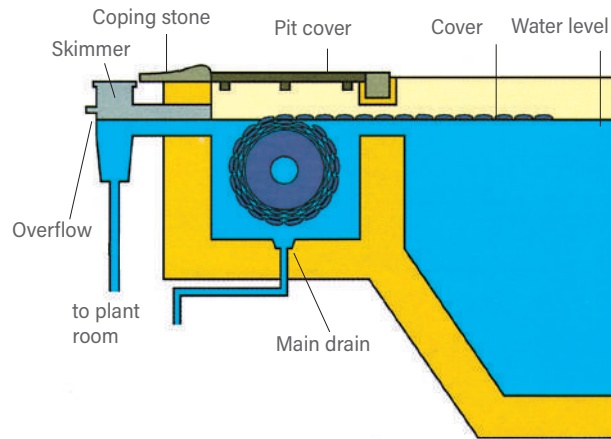

ROUSSILLON WITH MOTOR IN DRY PIT

0 < Axis depth below water level ≤ 0.55 m	Maxi WIDTH inside pool					
	6.53	7.03	8.03	9.03	10.03	11.03
MAXI Length inside pool (total with the pit)	Code FIF	Code FIF	Code FIF	Code FIF	Code FIF	Code FIF
4	060466ET	060466ET	060470ET	070440	070440	070440
5						
6						
7						
8						
9						
10	070443	070443	070444	060570	060570	
11						
12						
13						
14	070441	070441	070441	060570	060570	
15						
16						
17						
18	070441	070441	060570	060570	060570	
19						
20						

Submerged models

Roussillon submerged model: dry well motor



ROUSSILLON MODEL ASSEMBLY DRAWING

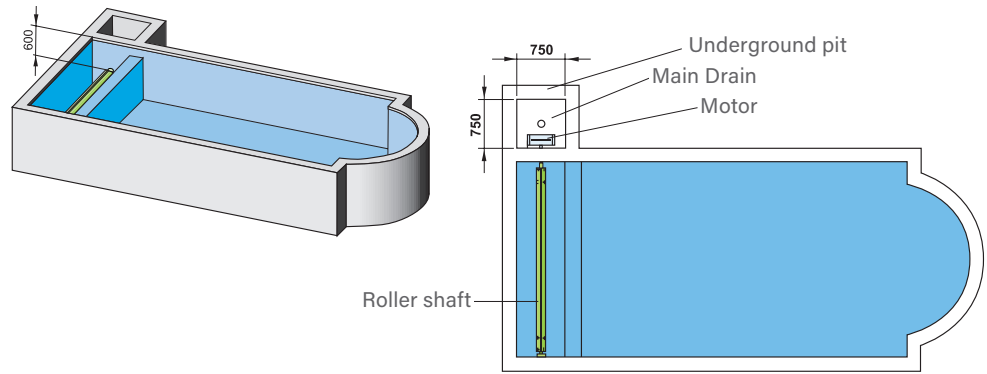

Watertight bushing



For further information see the AstralPool product database in the PRODUCTS section at www.astralpool.com.

Submerged models

Roussillon submerged model



KINK-PROOF SUPPORT FOR EMBEDDED BEAM

Supports must be used if the inner width of the pool shell is > 4 m.

The number of supports to be used is set out in the table below.

	Code	Standard Pack	Standard weight in kg	Standard volume in m ³
Kink-proof support to be mounted on wall				
DIMENSION of pit cover in mm				
615 ≤ Dim. ≤ 1015	61678	-	-	-
1016 ≤ Dim. ≤ 1460	61682	-	-	-

The pool may have beams on the corners of a maximum of 4 cm, in compliance with standard NF 90-308.

In the case of larger beams, the beam of the wall side must be brought forward by the same distance.

The clearance between the wall and the beam must be greater than 7 cm, otherwise it will not comply with standard NF 90-308.

PRACTICAL INFORMATION

Pool shell width	Number of beams required	Number of kink-proof supports required
Width ≤ 4 m	1 beam	0
4 m ≤ Width ≤ 6.03 m	1 beam	1
6.03 m ≤ Width ≤ 8.03 m	1 beam	2
8.03 m ≤ Width ≤ 9.03 m	1 beam of 4 m + 1 beam of 5 m	3
9.03 m ≤ Width ≤ 10.03 m	2 beams of 5 m	3
10.03 m ≤ Width ≤ 11.03 m	2 beams of 6 m	4

SAFETY SYSTEMS

Place the safety system on the shaft side and the step side IF THE DEPTH between the water level and pit cover is > 20 cm.

Dimensions to be taken into account:

A space measuring the height of at least the diameter of the cover when rolled plus 30 cm must be left free.

The inner width of the pit must be wider than the diameter of the shaft plus 20 cm (see diagram).

The clearance for the cover between the wall and the back of the pit cover must be between 5 and 7 cm, in compliance with standard NF 90-308.

The depth of the pit cover is up to the user. It should be at least 6 cm so that the cover works properly, and a maximum of 20 cm, in compliance with standard NF 90-308.

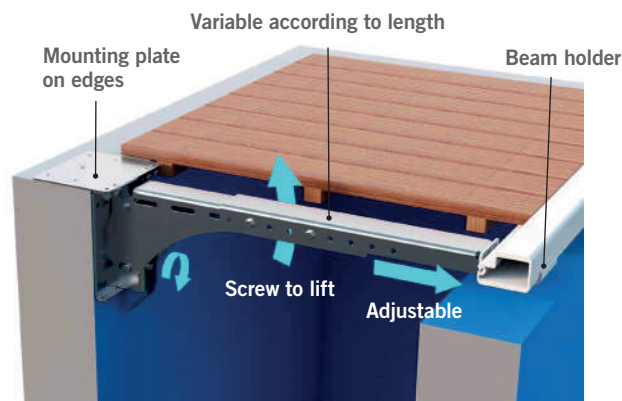

Submerged models

Roussillon submerged model: motor in the shaft

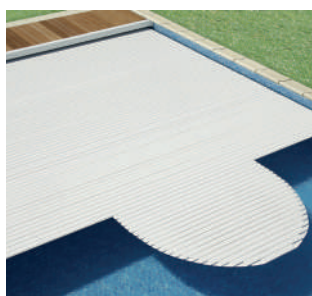

DESCRIPTION

The motor is integrated inside the winding shaft and can be installed in already-built pools up to 8 metres wide.

It can cover an indoor pool up to 8 x 12 m.

As in the Roussillon model the submerged part containing the roller shaft should be separated by a small concrete partition at the time of construction or later with a PVC partition. The slat colours available for both models are white, beige and opaque blue.

The Conflent mechanism may be fitted:

- Below the coping stone.
- Against the wall.



Mechanical system

Solution valid for a mechanical installation up to a maximum depth of 55 cm of the water level.
For greater depths, please enquire.

	Code	Standard Pack	Standard weight in kg	Standard volume in m ³
Max. pool dimensions				
Motor (shaft with limit switch)				
Pool 4 x 12 m	33070	-	-	-
Pool 5 x 12 m	33072	-	-	-
Pool 6 x 12 m	33073	-	-	-
Pool 7 x 14 m	33906	-	-	-

Dry-mounted grating

Dry-mounted grating



Wood. Width 25 mm



Aluminum. Width 28 mm

DESCRIPTION

The slabs are set back at least 50 mm and the gratings rest on:

- on both sides, on the beam and flush on the wall;
- on a bracket previously fixed to the wall.

Dimensions	Aluminium			Wood
	White	Sand	Grey	Exotic wood
	Code	Code	Code	Code
700 x 1 000 mm	0699191	060787	061170	0699211
950 x 1 000 mm	0699171	060788	061171	0699221
Custom-built: price per ml Maximum depth 1.50 m Multiple length of 125 mm	0699181	060789	061172	069923-01*

* Approx. 4 weeks for this custom-built finish.

Related Products



Stainless steel grating support bracket
l. 2.5 m - 67 x 67 mm + accessories

Code	0699271
------	---------



Submerged gratings

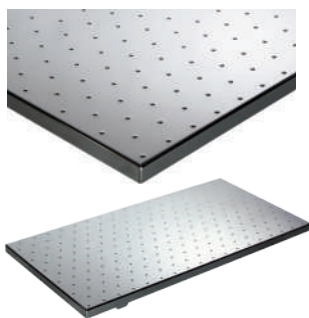

Solution 2: STAINLESS STEEL GRATING



DESCRIPTION

- Stainless steel gratings for submerged decking
- Material: AISI INOX 316L electro-polished (grade-A anti-slip surface according to DIN 51 097 standard)
- Dimensions: Custom-built
- Compatibility: fitted to the FIBER beam
- Weight: between 12 and 14 kg
- Maximum depth: 120 cm
- Thickness: 35 mm

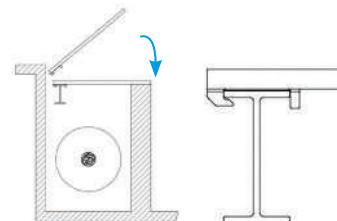

Submerged stainless steel grating

Designation	Code
Custom-built 316L stainless steel grating	070312*

*Thickness: 30 mm

* Épaisseur : 30 mm



With fastening system

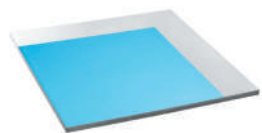

Lined version

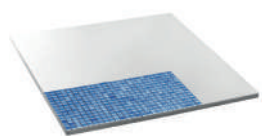

Tiled version

Solution 3: PVC GRATING



DESCRIPTION

for tiling or lining with reinforced PVC

- Extruded PVC grating for submerged decking
- Material: Rigid extruded WHITE PVC
- Use: the grating can be tiled or lined with reinforced PVC.
- Compatibility: fitted to the FIBER beam.

Dimensions	Weight out of water	Maximum depth if tiled	Maximum depth if lined with reinforced PVC	Code
1000 x 998 mm	43 kg	1 m	1,5 m	070378
Custom-built	-	-	-	070380

Installation configuration

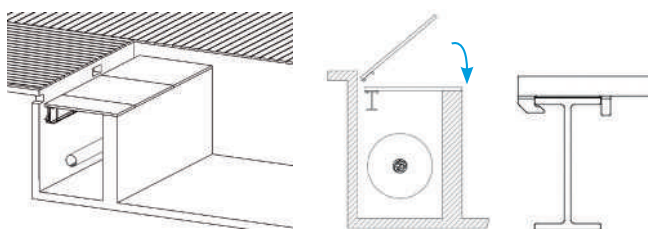

Tiled version:
 We recommend using special non-slip tiles for swimming pools.
 The grating must be installed with glue and epoxy sealant (not supplied with the grating).
 Tiled surfaces must be scratched beforehand to help keep the tiles in place.

Lined version:
 We recommend using 150/100 non-slip reinforced membrane. It can be welded or glued directly to the grating surface.

Submerged models

Accessories

DESCRIPTION

THE TIE BEAM

Its function is to provide support to the pit cover. Manufactured in white coated aluminium, it measures 100 x 110 mm and weighs 9 kg/ml.

This tie beam is delivered with coated stainless steel support bracket and stainless steel nuts and bolt.



Beam adjustable bracket



Wall tie-beam bracket

Beam length	Tie beam code 100 x 110	Tie beam code 100 x 70
White beam + Support bracket for fastening to the pool wall		
UP TO 4 meters	33874	56063
From 4 m to 5 m	33875	56064
From 5 m to 6 m	33876	-
Sand tie beam + Bracket to fasten to pool wall		
UP TO 4 meters	38544	56065
From 4 m to 5 m	38545	56066
From 5 m to 6 m	38546	-
White beam + Adjustable bracket		
UP TO 4 meters	35717	56057
From 4 m to 5 m	35718	56058
From 5 m to 6 m	35719	-
From 6 m to 7 m	35720	-
From 7 m to 8 m	35721	-
Sand beam + Adjustable bracket		
UP TO 4 meters	38539	56059
From 4 m to 5 m	38540	56060
From 5 m to 6 m	38541	-
From 6 m to 7 m	38542	-
From 7 m to 8 m	38543	-

Submerged models

Accessories



DESCRIPTION

KINK-PROOF SUPPORT FOR EMBEDDED BEAM

Supports must be used if the inner width of the pool shell is > 4 m.

Kink-proof bracket needed for tie beams over 5.5 m. Two kink-proof brackets needed for tie beams between 5.5 m and 7 m. For more information on kink-proof brackets, please enquire.

	Code	Standard Pack	Standard weight in kg	Standard volume in m ³
Kink-proof support to be mounted on wall				
DIMENSION of pit cover in mm of pit cover in mm				
615 ≤ Dim. ≤ 1015	61678	-	-	-
1016 ≤ Dim. ≤ 1460	61682	-	-	-

N. OF BRACKETS FOR A 100 X 70 TIE BEAM

Pool shell width	No. of tie beams needed	No. of kink-proof brackets needed
long. ≤ 3.03 m	1 tie beam	0
3.03 < long. ≤ 5.03 m		1
5.03 < long. ≤ 8.03 m	2 x 4m tie beams	3
8.03 < long. ≤ 9.03 m	1 x 4m tie beam + 1 x 5m tie beam	
9.03 < long. ≤ 10.03 m	2 x 5m tie beams	
10.03 < long. ≤ 11.03 m	3 x 4m tie beams	5

N. OF BRACKETS FOR A 100 X 110 TIE BEAM

Pool shell width	No. of tie beams needed	No. of kink-proof brackets needed
long. ≤ 5.5 m	1 tie beam	0
5.5 < long. ≤ 7.03 m		1
7.03 < long. ≤ 8.03 m		2
8.03 < long. ≤ 9.03 m	1 x 4m tie beam + 1 x 5m tie beam	3
9.03 < long. ≤ 10.03 m	2 x 5m tie beams	
10.03 < long. ≤ 11.03 m	1 x 5m tie beam + 1 x 6m tie beam	

Submerged models

Accessories



Tropical wood box cover



White aluminium compartment cover

Brackets for fastening to wall

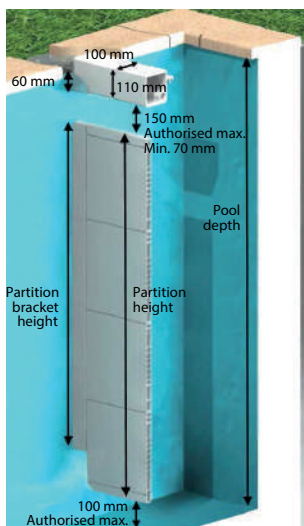

Brackets for fastening to beam brackets

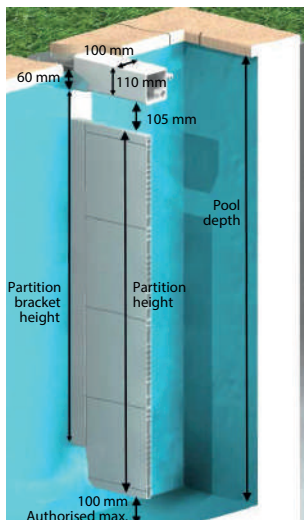

DESCRIPTION

THE PIT COVER

The pit cover protects the automatic cover operating unit and conveys an aesthetic improvement to the surroundings. It is available in wood, or in white aluminium.

For pools with a partition wall the cover will be 950 mm wide, while for pools with a PVC partition the 700 mm lid will be used.

Thickness of the wooden pit cover: 25 mm.

Thickness of the aluminium pit cover: 28 mm.

	Code	Standard Pack	Standard weight in kg	Standard volume in m ³
Made of tropical wood (1.00 x 0.70 m)	31152	-	-	-
Made of tropical wood (1.00 x 0.95 m)	31153	-	-	-
Tropical wood made to order (m ²)	31154	-	-	-
White aluminium 1.00 x 0.70 m	33679	-	-	-
White aluminium 1.00 x 0.95 m	33680	-	-	-
White aluminium made to measure, m ²	33681	-	-	-
Sand aluminium 1.00 x 0.70 m	38512	-	-	-
Sand aluminium 1.00 x 0.950 m	38513	-	-	-
Sand aluminium made to measure, m ²	38514	-	-	-

PVC PARTITION

The partition can be made of concrete or PVC. It is designed to improve safety by preventing bathers from coming into contact with the roller shaft. It also prevents the pool-floor cleaning hose from being rolled up into the slats.

The partition is made up of 250 mm high PVC panels, internally reinforced with stainless steel. It is fastened with two white coated stainless steel U clamps, which are fastened to the tie beam support bracket.

Will be fastened to vertical walls.

For pools of more than 6 m width ask your AstralPool branch.

	Code	Standard Pack	Standard weight in kg	Standard volume in m ³
White partition				
900 mm x 4 m	31158	-	-	-
900 mm x 5 m	31159	-	-	-
900 mm x 6 m	31160	-	-	-
1200 mm x 4 m	31161	-	-	-
1200 mm x 5 m	31162	-	-	-
1200 mm x 6 m	31163	-	-	-
1500 mm x 4 m	33077	-	-	-
1500 mm x 5 m	33078	-	-	-
1500 mm x 6 m	38523	-	-	-

White Stainless Steel U-shaped brackets to fasten to wall

H 900 mm	31164	-	-	-
H 1200 mm	31165	-	-	-
H 1500 mm	33084	-	-	-

White Stainless Steel U-shaped brackets to fasten to wall

H 900 mm on tie-beam bracket	33083	-	-	-
------------------------------	-------	---	---	---

S.S. U clamps colour White

H 1200 mm on beam bracket	38549	-	-	-
H 1500 mm on beam bracket	38550	-	-	-

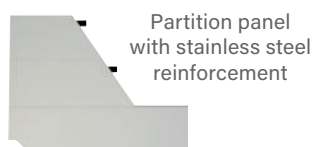

U-bracket for fastening to the beam supports



U-bracket for fastening to wall

PVC slats

PVC slats



WHITE



SAND



LIGHT



MEDIUM GREY

DESCRIPTION

The AstralPool automatic cover uses hollow extrusion PVC watertight slats. The end-caps welded at both ends ensure the tightness of the slats and the 20mm wide cap flaps can assure the total length of the slat. Flaps can also be 10 or 30 mm, altering the total width of the pool cover.

The slats measure 71.4 mm long and are 17 mm thick, so that they are able to float. To prevent stains, particularly organic ones, the slats are stabilized with calcium and zinc.

To ensure a cover blends in with its surroundings, a number of slat models are available: white, sand, blue and grey.

	Code	Standard Pack	Standard weight in kg	Standard volume in m ³
Bracket cut	31180	-	-	-
In shape cut	38735	-	-	-

TECHNICAL FEATURES

Pool width (m)	White		Sand		Grey		Medium Grey	
	Ref.	Code	Ref.	Code	Ref.	Code	Ref.	Code
width ≤ 3.53	060540	34755	060546	34761	060645	40998	061857	061857
3.53 < width ≤ 4.03	060400	31168	060406	31169	060647	41000	061858	061858
4.00 < width ≤ 4.50	060541	34756	060547	34762	060648	41001	061859	061859
4.53 < width ≤ 5.03	060402	31172	060407	31173	060649	40761	0618601	0618601
5.03 < width ≤ 5.53	060542	34757	060548	34763	060650	41002	0618611	0618611
5.53 < width ≤ 6.03	060404	31176	060408	31177	060651	41003	061862	061862
6.03 < width ≤ 7.03	060405	31900	060409	31901	060652	40762	061863	061863
7.03 < width ≤ 8.03	060399	31905	060418	31906	060653	41004	061864	061864
8.03 < width ≤ 9.03	060582	35132	060586	35134	061262	54588	061865	061865
9.03 < width ≤ 10.03	060583	35133	060587	35135	061406	54589	061866	061866
10.03 < width ≤ 11.03	060398	33112ANT	060588	35136	061407	54590	061867	061867

Please enquire for larger widths.

PVC slats

PVC slats



WHITE



SAND



LIGHT

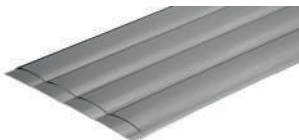

MEDIUM GREY

	Code	Standard Pack	Standard weight in kg	Standard volume in m ³
Pool width (m) - White				
width ≤ 3.53	34755	-	-	-
3.53 < width ≤ 4.03	31168	-	-	-
4.00 < width ≤ 4.50	34756	-	-	-
4.53 < width ≤ 5.03	31172	-	-	-
5.03 < width ≤ 5.53	34757	-	-	-
5.53 < width ≤ 6.03	31176	-	-	-
6.03 < width ≤ 7.03	31900	-	-	-
7.03 < width ≤ 8.03	31905	-	-	-
8.03 < width ≤ 9.03	35132	-	-	-
9.03 < width ≤ 10.03	35133	-	-	-
10.03 < width ≤ 11.03	33112ANT	-	-	-
Pool width (m) - Sand				
width ≤ 3.53	34761	-	-	-
3.53 < width ≤ 4.03	31169	-	-	-
4.00 < width ≤ 4.50	34762	-	-	-
4.53 < width ≤ 5.03	31173	-	-	-
5.03 < width ≤ 5.53	34763	-	-	-
5.53 < width ≤ 6.03	31177	-	-	-
6.03 < width ≤ 7.03	31901	-	-	-
7.03 < width ≤ 8.03	31906	-	-	-
8.03 < width ≤ 9.03	35134	-	-	-
9.03 < width ≤ 10.03	35135	-	-	-
10.03 < width ≤ 11.03	35136	-	-	-
Pool width (m) - Grey				
width ≤ 3.53	40998	-	-	-
3.53 < width ≤ 4.03	41000	-	-	-
4.00 < width ≤ 4.50	41001	-	-	-
4.53 < width ≤ 5.03	40761	-	-	-
5.03 < width ≤ 5.53	41002	-	-	-
5.53 < width ≤ 6.03	41003	-	-	-
6.03 < width ≤ 7.03	40762	-	-	-
7.03 < width ≤ 8.03	41004	-	-	-
8.03 < width ≤ 9.03	54588	-	-	-
9.03 < width ≤ 10.03	54589	-	-	-
10.03 < width ≤ 11.03	54590	-	-	-
Pool width (m) - Medium Grey				
width ≤ 3.53	061857	-	-	-
3.53 < width ≤ 4.03	061858	-	-	-
4.00 < width ≤ 4.50	061859	-	-	-
4.53 < width ≤ 5.03	0618601	-	-	-
5.03 < width ≤ 5.53	0618611	-	-	-
5.53 < width ≤ 6.03	061862	-	-	-
6.03 < width ≤ 7.03	061863	-	-	-
7.03 < width ≤ 8.03	061864	-	-	-
8.03 < width ≤ 9.03	061865	-	-	-
9.03 < width ≤ 10.03	061866	-	-	-
10.03 < width ≤ 11.03	061867	-	-	-

PVC slat accessories



	Code	Standard Pack	Standard weight in kg	Standard volume in m ³
Caps for grey polycarbonate slats				
Right plug TRANSPARENT	070243	-	-	-
Left plug TRANSPARENT	070242	-	-	-
Right plug SOLAR GREY	907557	-	-	-
Left plug SOLAR GREY	907556	-	-	-

Step slats



Step slats

In order to adapt to any swimming pool shape, three different standard geometric shapes are available, thus ensuring a perfect fit to the outline of a pool and maximum safety.

The shapes available are: Roman steps, Straight steps and Trapezoidal steps.

METHOD FOR CALCULATING STEPS SLATS

ROMAN STEPS

Location:

It must be located on the side opposite to the cover shaft.

Step price:

Roman step pricelist.

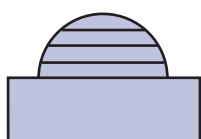

ISOSCELES TRAPEZOIDAL STEPS

Location:

Located in front of the cover.

Step price:

Trapezoidal step pricelist.

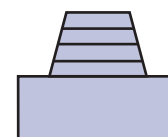

STRAIGHT STEPS

Location:

a) Located in front of the cover shaft.

Step price:

Straight step price.

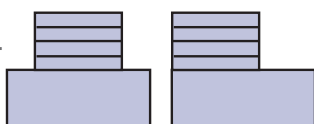

RECTANGULAR TRAPEZOIDAL STEPS

Location:

a) Located in front of the cover shaft.

Step price:

Trapezoidal step pricelist.

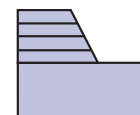

Location:

b) Located next to the cover.

Step price:

Slat pricelist per metre length $D \times (C + 1 m)$.

- The length of the shaft (D) includes the width of the pool (A) + the depth of the steps (E).

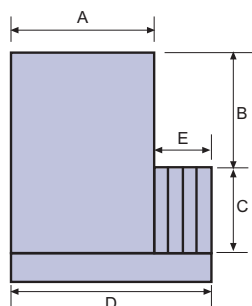

Location:

b) Located next to the cover.

Step price:

Slat price per metre length

$D \times (C + 1 m)$ + slat cutting surcharge for custom cutting per metre length.

- Length of D axis includes A length of pool + E depth of step

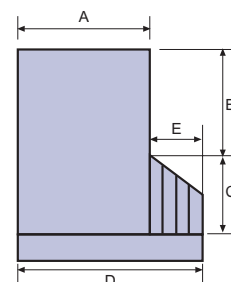

NOTE FOR SIDE STEPS:

Total slat cost calculation:

Step price + slat price (A x B)

NOTE FOR SIDE STEPS:

Total slat cost calculation:

Step price + slat price (A x B)

TECHNICAL FEATURES

Description	White	Sand	Blue	Grey	Medium Grey
Roman step bracket cut					
Ø 3 m	31182	31183	31184	41043	061868
Ø 4 m	31186	31187	31188	41044	061869
Roman step in-shape cut					
Ø 3 m	37094	37188	37190	41045	061870
Ø 4 m	37095	37189	37191	41046	061871
Straight steps					
2 x 1,5 m	31190	31191	31192	41047	061872
2,5 x 2 m	31194	31195	31196	41048	061873
Trapezoidal step bracket cut					
base 3 m	31198	31199	31200	41049	061874
base 4 m	31202		31204	41050	061875
Shape-cut Trapezoidal ladder					
base 3 m	37098	37196	37198	41051	061876
base 4 m	37099	37197	37199	41052	061877

Larger steps: use surplus cut-outs in shape 38735 or bracket 31180 per metre length.

Step slats



Step slats

		Code	Standard Pack	Standard weight in kg	Standard volume in m ³
White					
Roman step bracket cut	Ø 3 m	31182	-	-	-
	Ø 4 m	31186	-	-	-
Roman step in-shape cut	Ø 3 m	37094	-	-	-
	Ø 4 m	37095	-	-	-
Straight steps	2 x 1,5 m	31190	-	-	-
	2.5 x 2 m	31194	-	-	-
Trapezoidal step bracket cut	base 3 m	31198	-	-	-
	base 4 m	31202	-	-	-
Shape-cut Trapezoidal ladder	base 3 m	37098	-	-	-
	base 4 m	37099	-	-	-
Sand					
Roman step bracket cut	Ø 3 m	31183	-	-	-
	Ø 4 m	31187	-	-	-
Roman step in-shape cut	Ø 3 m	37188	-	-	-
	Ø 4 m	37189	-	-	-
Straight steps	2 x 1,5 m	31191	-	-	-
	2.5 x 2 m	31195	-	-	-
Trapezoidal step bracket cut	base 3 m	31199	-	-	-
	base 4 m	-	-	-	-
Shape-cut Trapezoidal ladder	base 3 m	37196	-	-	-
	base 4 m	37197	-	-	-
Grey					
Roman step bracket cut	Ø 3 m	41043	-	-	-
	Ø 4 m	41044	-	-	-
Roman step in-shape cut	Ø 3 m	41045	-	-	-
	Ø 4 m	41046	-	-	-
Straight steps	2 x 1,5 m	41047	-	-	-
	2.5 x 2 m	41048	-	-	-
Trapezoidal step bracket cut	base 3 m	41049	-	-	-
	base 4 m	41050	-	-	-
Shape-cut Trapezoidal ladder	base 3 m	41051	-	-	-
	base 4 m	41052	-	-	-
Medium grey					
Roman step bracket cut	Ø 3 m	061868	-	-	-
	Ø 4 m	061869	-	-	-
Roman step in-shape cut	Ø 3 m	061870	-	-	-
	Ø 4 m	061871	-	-	-
Straight steps	2 x 1,5 m	061872	-	-	-
	2.5 x 2 m	061873	-	-	-
Trapezoidal step bracket cut	base 3 m	061874	-	-	-
	base 4 m	061875	-	-	-
Shape-cut Trapezoidal ladder	base 3 m	061876	-	-	-
	base 4 m	061877	-	-	-

Polycarbonate slats and steps

Polycarbonate slats

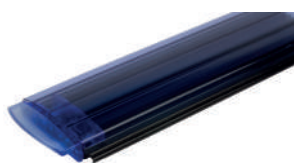

SOLAR BLUE



SOLAR TRANSPARENT



SOLAR GREY



DESCRIPTION

Main advantages of polycarbonate slats:

- Strong impact resistance: Polycarbonate slats are approximately 8 times more resistant than PVC slats.
- Heat resistance: the deformation point is 140° compared to 80° for PVC.
- Very good ageing resistance thanks to UV protection layer on the top of the slat.
- Polycarbonate's lower density means the slats float better.
- Compliant with standard NF P 90-308.
- 3-year warranty
- Slat dimensions: 71 x 17 mm.

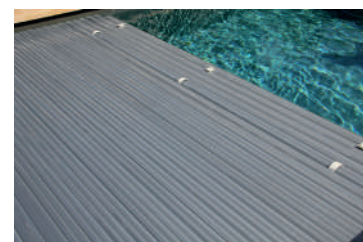
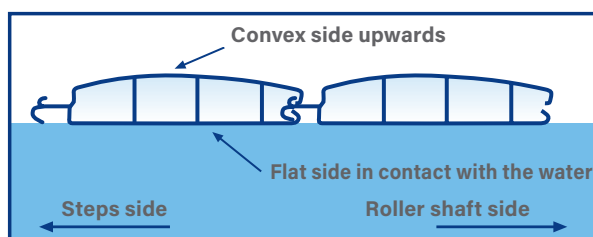

TECHNICAL FEATURES

Pool length (m)	Solar Blue	Solar transparent	Solar Grey
	Code	Code	Code
long < 4.03 m	061547	070420	070266
4.03 m < long < 5.03 m	061548	070421	070265
5.03 m < long < 6.03 m	061549	070422	070267
6.03 m < long < 7.03 m	061550	070423	070268
7.03 m < long < 8.03 m	061551	070424	070269

For bigger widths, please enquire. ml = metre length. Available in other colours, please enquire.

	Code	Standard Pack	Standard weight in kg	Standard volume in m ³
Solar Blue				
long < 4.03 m	061547	-	-	-
4.03 m < long < 5.03 m	061548	-	-	-
5.03 m < long < 6.03 m	061549	-	-	-
6.03 m < long < 7.03 m	061550	-	-	-
7.03 m < long < 8.03 m	061551	-	-	-
Solar Transparent				
long < 4.03 m	070420	-	-	-
4.03 m < long < 5.03 m	070421	-	-	-
5.03 m < long < 6.03 m	070422	-	-	-
6.03 m < long < 7.03 m	070423	-	-	-
7.03 m < long < 8.03 m	070424	-	-	-
Solar Grey				
long < 4.03 m	070266	-	-	-
4.03 m < long < 5.03 m	070265	-	-	-
5.03 m < long < 6.03 m	070267	-	-	-
6.03 m < long < 7.03 m	070268	-	-	-
7.03 m < long < 8.03 m	070269	-	-	-

Polycarbonate slats and steps

Polycarbonate steps

TECHNICAL FEATURES

Stair type and measurements	Solar Blue	Transparent	Solar transparent	Solar Grey
	Code	Code	Code	Code
Roman step bracket cut diam < 3 m	061604	070081	070425	070270
Roman step bracket cut 3 m < diam < 4 m	061505	070082	070426	070271
Roman step bracket cut max 2 m depth 1.5 m	061606	070085	070427	070272
Roman step bracket cut max 2.5 m depth 2 m	061607	070086	070428	070273
Trapezoidal step bracket cut max 3 m	061608	070087	070429	070274
Trapezoidal step bracket cut max 4 m	061609	070088	070430	070275

	Code	Standard Pack	Standard weight in kg	Standard volume in m ³
Solar Blue				
Roman step bracket cut diam < 3 m	061604	-	-	-
Roman step bracket cut 3 m < diam < 4 m	061505	-	-	-
Roman step bracket cut max 2 m depth 1.5 m	061606	-	-	-
Roman step bracket cut max 2.5 m depth 2 m	061607	-	-	-
Trapezoidal step bracket cut max 3 m	061608	-	-	-
Trapezoidal step bracket cut max 4 m	061609	-	-	-
Solar Transparent				
Roman step bracket cut diam < 3 m	070425	-	-	-
Roman step bracket cut 3 m < diam < 4 m	070426	-	-	-
Roman step bracket cut max 2 m depth 1.5 m	070427	-	-	-
Roman step bracket cut max 2.5 m depth 2 m	070428	-	-	-
Trapezoidal step bracket cut max 3 m	070429	-	-	-
Trapezoidal step bracket cut max 4 m	070430	-	-	-
Solar Grey				
Roman step bracket cut diam < 3 m	070270	-	-	-
Roman step bracket cut 3 m < diam < 4 m	070271	-	-	-
Roman step bracket cut max 2 m depth 1.5 m	070272	-	-	-
Roman step bracket cut max 2.5 m depth 2 m	070273	-	-	-
Trapezoidal step bracket cut max 3 m	070274	-	-	-
Trapezoidal step bracket cut max 4 m	070275	-	-	-



Polycarbonate slat accessories

	Code	Standard Pack	Standard weight in kg	Standard volume in m ³
Caps for grey polycarbonate slats				
Right plug TRANSPARENT	070243	-	-	-
Left plug TRANSPARENT	070242	-	-	-
Right plug SOLAR BLUE	070259	-	-	-
Left plug SOLAR BLUE	070260	-	-	-
Right plug SOLAR GREY	907557	-	-	-
Left plug SOLAR GREY	907556	-	-	-

Accessories



Safety systems

in AISI-316 stainless steel (glossy)



DESCRIPTION

- Thickness: 15.3 mm
- Height: 52.1 mm
- Width: 30 mm

Aesthetics: In glossy AISI-316 stainless steel + coloured strap



White

Sand

Grey

Blue

Easy to handle



	Code	Standard Pack	Standard weight in kg	Standard volume in m ³
S.S. safety system for fastening				
to wall with white PVC strap	070317	-	-	-
to surface (height of 50 mm) with white PVC strap	070318	-	-	-
to surface (height of 100 mm) with white PVC strap	070321	-	-	-
to wall with sand PVC strap	070322	-	-	-
to surface (height of 50 mm) with sand PVC strap	070323	-	-	-
to surface (height of 100 mm) with sand PVC strap	070324	-	-	-
to wall with grey PVC strap	070328	-	-	-
to surface (height of 50 mm) with grey PVC strap	070329	-	-	-
to surface (height of 100 mm) with grey PVC strap	070330	-	-	-
to wall with blue PVC strap	070331	-	-	-
to surface (height of 50 mm) with blue PVC strap	070332	-	-	-
to surface (height of 100 mm) with blue PVC strap	070333	-	-	-

Easy to install:
fastens to wall or on surface
at two possible heights



Accessories



Fabric strap tying system

DESCRIPTION

Good value for money.

	Code	Standard Pack	Standard weight in kg	Standard volume in m ³
Fabric safety system for fastening				
to white wall	070316	-	-	-
to white wall (height of 50 mm)	070334	-	-	-
to white wall (height of 100 mm)	070335	-	-	-

Easy to install:
fastens to wall or on surface
at two possible heights



ABS safety systems

DESCRIPTION

We have a line of accessories for both using and maintaining automatic covers.

In compliance with the French standard NF P90-308 on swimming pool covers the following straps will be supplied according to the kind of cover and pool:

	Code	Standard Pack	Standard weight in kg	Standard volume in m ³
Liner accessories				
Lift-prevention bracket in ABS for wall fixing + belts	34754	-	-	-
ABS bracket + S.S. support to install under the coping stone + belt	35131	-	-	-
Overflow pool bracket	31943	-	-	-
Sky cover, above-ground model	31944	-	-	-
Slat-shaft joint belt	31238	-	-	-
Flange belt	34774	-	-	-

Interior pool width	No. of flanges for above-ground covers	No. of flanges for submerged covers
Width <= 3 m	4	2
3 m < width <= 5 m	6	3
5 m < width <= 7 m	8	4
7 m < width <= 10 m	10	5



35131



34754

Wireless remote controls with key

Cover Connect



DESCRIPTION

Cover Connect, remote control for submerged rollers





COVER CONNECT mobile App

DESCRIPTION

- **NF P90-308 standard-compliant**
 - Enables opening and closing of the cover via Bluetooth with distance limitation.
 - Secure password access.
- **Easy to install**
 - Automatic connection to the wall control unit.
 - Guided pairing procedure for easy installation.
 - Access to product documentation.
- **Flexibility**
 - Android and iOS compatible (downloadable from Play Store and App Store).
 - 8 languages available.
 - Unlimited number of smartphones can be paired.
 - Possibility of pairing 2 wall remote controls and 2 keyring remote controls.
- **Free application without subscription**



Description	NF P90-308 standard-compliant	Mobile app compatibility	Code
 <p>Wireless wall-mounted remote control unit + app</p>	✓	✓	070562
 <p>Keyring remote control Not compliant with the NP P90-308 standard</p>	✗	✗	907672

Wireless remote control with key

Remote control

for automatic covers



- + One single electrical cabinet for all types of submerged covers
- + Easy installation and maintenance

DESCRIPTION

Chlorination control

Reduced chlorine production with cover deployed

Filtration pump control

Temporary filtration pump shutdown during cover operation. Useful for infinity pools to avoid cover deviations.

Water level sensor input

The control cabinet is fitted with an automatic water level sensor that blocks cover operations if the water level is too low or too high. It can also be combined with an emergency stop button.



Programmable soft start

- Cover comes out towards the surface of the water at low speed to avoid jamming.
- Position 1 programmable according to the depth of the cover reel.
- Engine speed reduced to 60%.

Cover braking during unrolling

- Unlike older enclosures that suffer from Archimedes' thrust causing the cover to accelerate, the universal power supply incorporates a braking system to limit the speed at which the cover comes out towards the surface of the water.
- This braking system is necessary to control the speed at which the cover comes out (soft start).
- This feature is particularly useful for submerged covers with special shapes to prevent them from coming to the surface too quickly.

Compatible with Fluidra Connect

- Remote query of cover status: open / closed
- An advantage for professionals: remote monitoring of installed covers
- Preventive maintenance.
- Pool equipment harmonized with the cover: chlorination, pool robot, heat pump, filtration, etc.

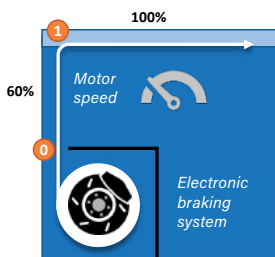

	Code	Standard Pack	Standard weight in kg	Standard volume in m ³
Electrical cabinet				
Power 200 VA	070574	-	-	-
Power 400 VA	070575	-	-	-

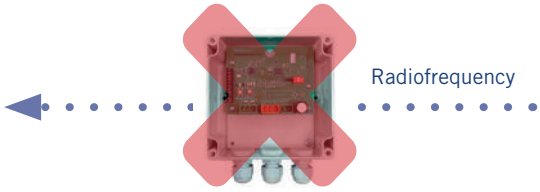

The external receiver will not be necessary

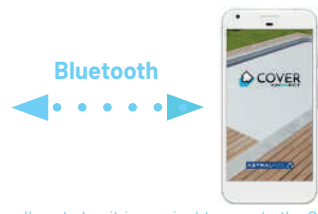

For submerged covers, the wall control unit is required to operate the Cover Connect app. Installed near the pool, it enables control of the cover using a smartphone while maintaining the distance limitation required by the NF P-90 30 standard

Technical specifications

Ø BOBINE (mm) shaft + slats)

LENGTH of the pool	ALU Shaft	INOX Shaft (Ø 300 mm)
1 m	260	335
2 m	320	370
3 m	350	405
4 m	390	440
5 m	420	472
6 m	450	472
7 m	470	510
8 m	490	540
9 m	520	540
10 m	530	575
11 m	560	575
12 m	570	610
13 m	590	610
14 m	610	645
15 m	640	645
16 m	660	680
17 m	680	680
18 m	700	715
19 m	720	715
20 m	730	750
23 m		800
25 m		850

Above water gratings

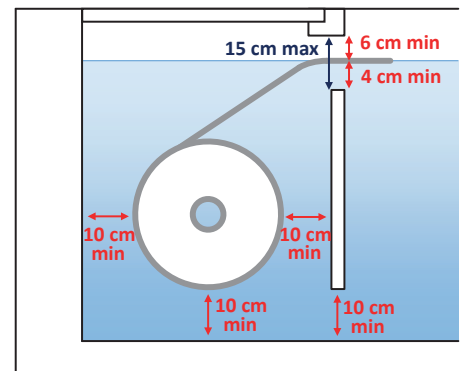

Under water gratings

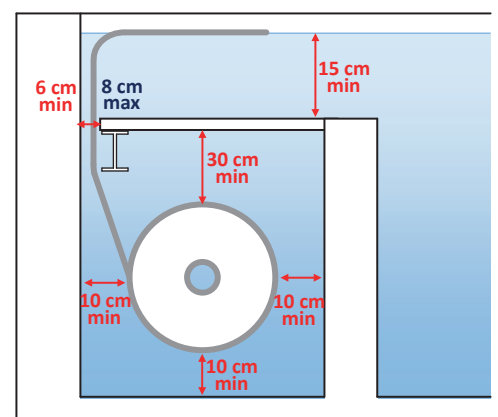

COVERS AND ROLLERS

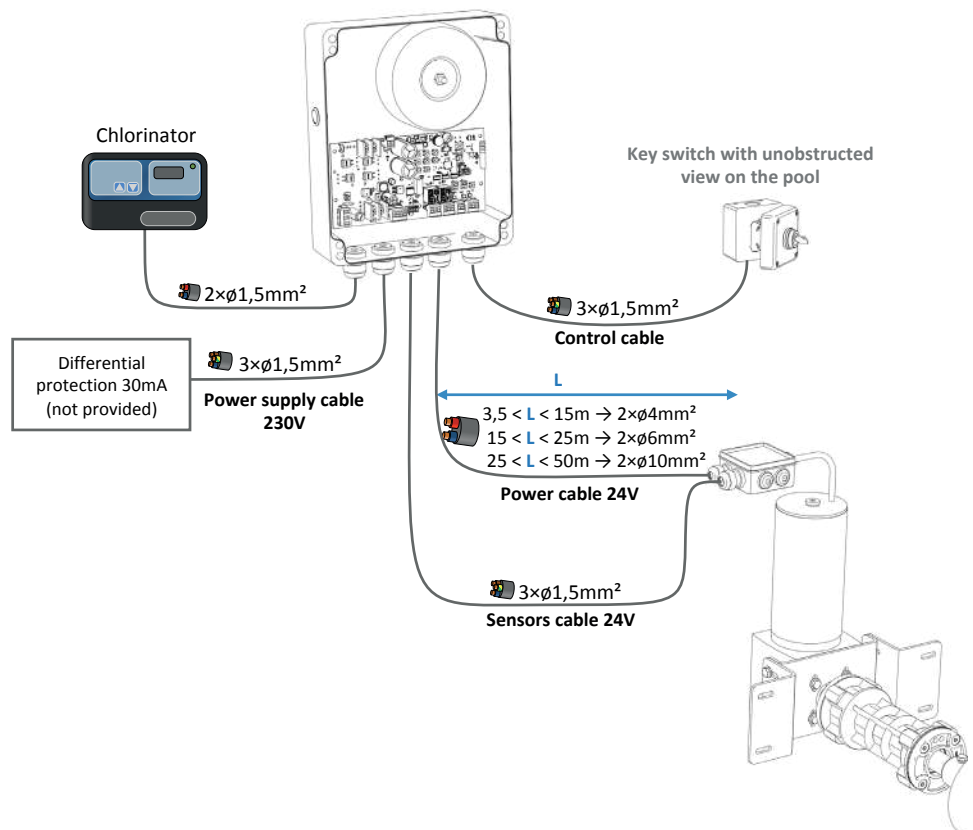





PVC FITTINGS



- | | | | |
|-----|--|-----|---|
| 419 | Fitt B-Active and Fitt Idroflex | 425 | Filter ring manifolds for 3/4" laterals |
| 420 | Pressure fluid handling PVC PN-16 fittings | 426 | Filter ring manifolds for 1" laterals |
| 422 | Pressure PVC valves | 427 | Diffuser filter |
| 423 | Pressure fluid handling PVC accessories | 427 | Collectors for valve manifolds |

fitt b-active: resistant, flexible, safe

FITT B-Active Flex: the **EVO TECH** technology makes the hose 6 times more resistant to cracking than other hoses - based on the requirements of the EN ISO 3994 standard -, and protects it whilst preserving the high flexibility and narrow bending radius characteristics.

FITT B-Active Rigid: the **SHOCK WAVE** technology makes the pipe 40 times more shock resistant than the minimum required by the EN ISO 1452 standard, and therefore ideal for use even at the lowest temperatures.

FITT B-Active Flex & Rigid can be perfectly integrated in all projects, ensuring maximum safety, resistance and duration.

bactive.fitt.com
FITT.com



*FITT offers a 10-year guarantee together with a special 10-year insurance coverage.



FITT B-Active Flex



FITT B-Active Rigid



PVC FITTINGS

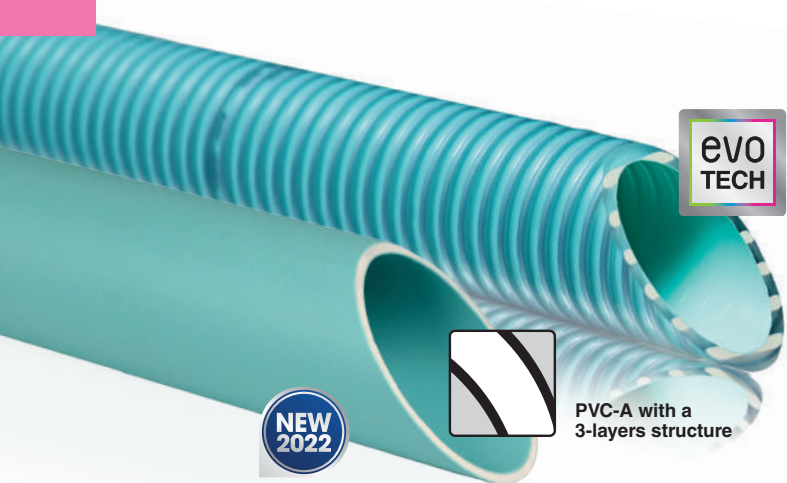

Even more resistant to cracking



PVC-A with a 3-layers structure



FITT B-ACTIVE AND FITT IDROFLEX

Fitt B-active RIGID



Conforms to the EN ISO 3994:2014 standard
TUV approval no. B 17 04 55285 007

DESCRIPTION

- Mechanical and chemical performance tests were run both internally and with the collaboration of Padua University/DTG Laboratory. Test certified by TÜV (test record no. MEC16173.00).
- Complies with European Directive (EU) 10/2011 for A-B-C simulants
- Operating temperature -10°C/+60°C.
- Formula with phthalate content ≤ 0.1 %.

Tolerances comply with standard UNI EN ISO 1307: 2008. Thermoplastic products subject to deformation due to outdoor ambient temperature and retraction; longitude tolerance is ± 5%.

TECHNICAL FEATURES

Product	External Ø (mm)	Pressure (bar)	Pressure distribution (bar)	Drainage (m H ₂ O)	Bend radius (mm)	Ring stiffness (kN/m ²)
FITT B-ACTIVE Ø50	50	6	18	9	125	34
FITT B-ACTIVE Ø63	63	4	12	9	165	22

LOGISTICAL FEATURES

Code	Product	External Ø (mm)	Roll length (m)	Weight (kg/roll)	Quantity (roll/pal)	Pallet dimensions (mm)
69860	FITT B-ACTIVE RIGID Ø50 25m	50	25	19	12	800x1600xH1240
69861	FITT B-ACTIVE RIGID Ø50 50m	50	50	37,5	8	800x1600xH1360
69862	FITT B-ACTIVE RIGID Ø63 25m	63	25	24,5	6	1200x1000xH1280
73443	FITT B-ACTIVE RIGID Ø63 L4 PN16	-	-	-	-	-
73444	FITT B-ACTIVE RIGID Ø63 L2 PN16	-	-	-	-	-
73445	FITT B-ACTIVE RIGID Ø50 L2 PN10	-	-	-	-	-
73446	FITT B-ACTIVE RIGID Ø50 L4 PN10	-	-	-	-	-
73447	FITT B-ACTIVE RIGID Ø50 L1,2 PN16	-	-	-	-	-
73448	FITT B-ACTIVE RIGID Ø50 L2 PN16	-	-	-	-	-
73449	FITT B-ACTIVE RIGID Ø50 L4 PN166	-	-	-	-	-
73450	FITT B-ACTIVE RIGID Ø63 L2 PN10	-	-	-	-	-
73451	FITT B-ACTIVE RIGID Ø63 L4 PN10	-	-	-	-	-
73452	FITT B-ACTIVE RIGID Ø63 L1,2 PN16	-	-	-	-	-



Fitt Idroflex



Conforms to the EN ISO 3994:2014 standard
TUV approval no. B 17 04 55285 007

LOGISTICAL FEATURES

Code	Product	External Ø (mm)	Operating pressure (bar)	Drainage (m H ₂ O)	Roll length (m)	Weight (kg/roll)	Quantity (roll/pal)	Pallet dimensions (mm)
69852	FITT IDROFLEX Ø25 50m	25	7	7	50	12,5	12	800x1200xH1200
69853	FITT IDROFLEX Ø32 50m	32	7	7	50	21,0	16	1200x1200xH1200
69855	FITT IDROFLEX Ø40 25m	40	5	7	25	15,5	16	1200x1200xH1200
69854	FITT IDROFLEX Ø40 50m	40	5	7	50	30,5	5	800x1200xH1200
69857	FITT IDROFLEX Ø50 25m	50	5	7	25	16	12	800x1600xH1240
69856	FITT IDROFLEX Ø50 50m	50	5	7	25	31,5	8	800x1600xH1360
69858	FITT IDROFLEX Ø63 25m	63	4	7	25	23	6	1200x1000xH1280
69859	FITT IDROFLEX Ø75 25m	75	2,5	6	25	37	3	1200x1200xH1200
69963	FITT IDROFLEX Ø75 25m	32	7	7	25	7	12	1200x800xH1360
69966	FITT IDROFLEX Ø75 25m	20	7	7	25	4	48	1200x800xH1360



PVC 90° elbow

Solvent socket



	Code	Standard Pack	Standard weight in kg	Standard volume in m ³
Ø 50 mm	32588	70	8.67	0.0408
Ø 63 mm	32589	36	7.86	0.0408
Ø 75 mm	01718	21	8.6	0.0408
Ø 90 mm	01719	12	8.7	0.0408
Ø 110 mm	01720	14	17.8	0.082



PVC 45° elbow

Solvent socket



	Code	Standard Pack	Standard weight in kg	Standard volume in m ³
Ø 50 mm	32590	40	3.72	0.0204
Ø 63 mm	32591	20	3.56	0.0204
Ø 75 mm	01752	25	8.2	0.0408
Ø 90 mm	01753	15	8.3	0.0408
Ø 110 mm	01754	16	13.8	0.082



PVC-Tee 90°

Solvent socket



	Code	Standard Pack	Standard weight in kg	Standard volume in m ³
Ø 50 mm	32592	48	8.95	0.0408
Ø 63 mm	32593	30	9.73	0.0408
Ø 75 mm	01786	15	8.4	0.0408
Ø 90 mm	01787	8	7.4	0.0408
Ø 110 mm	01788	10	16.4	0.082



PVC union

Solvent socket



	Code	Standard Pack	Standard weight in kg	Standard volume in m ³
Ø 50 mm	32594	60	4.48	0.0204
Ø 63 mm	32595	35	3.98	0.0204
Ø 75 mm	01878	14	3.5	0.02
Ø 90 mm	01879	18	7.6	0.0408
Ø 110 mm	01880	12	8.5	0.0408



PVC reducing bush

Solvent socket

ASTRALPOOL 

	Code	Standard Pack	Standard weight in kg	Standard volume in m ³
Ø 63 mm x 50 mm	32596	48	3.08	0.0102
Ø 75 mm x 63 mm	01928	28	2.2	0.01
Ø 75 mm x 50 mm	18685	28	3.3	0.01
Ø 90 mm x 75 mm	01929	36	5.1	0.02
Ø 90 mm x 63 mm	18687	36	6	0.02
Ø 90 mm x 50 mm	18688	36	6.4	0.02
Ø 110 mm x 90 mm	01930	16	4.3	0.02
Ø 110 mm x 75 mm	18689	16	5.1	0.02
Ø 110 mm x 63 mm	18690	16	5	0.02



PVC adaptor nipple

Solvent socket & BSP male thread

ASTRALPOOL 

	Code	Standard Pack	Standard weight in kg	Standard volume in m ³
Ø 50 mm x 40 mm x 1½"	32597	24	2.48	0.0102
Ø 63 mm x 50 mm x 2"	32598	38	5.84	0.0204
Ø 75 mm x 63 mm x 2½"	02091	24	4.7	0.02
Ø 90 mm x 75 mm x 3"	02094	12	3.6	0.02
Ø 110 mm x 90 mm x 4"	02097	6	3.8	0.02



PVC adaptor bush

Female solvent socket & BSP male thread

ASTRALPOOL 

	Code	Standard Pack	Standard weight in kg	Standard volume in m ³
Ø 50 mm x 1½"	32599	48	3.27	0.0102
Ø 63 mm x 2"	32600	50	5.60	0.0204
Ø 75 mm x 2½"	02108	24	6.1	0.02
Ø 90 mm x 3"	02109	28	11.7	0.0408
Ø 110 mm x 4"	02110	10	6.3	0.0408



PVC 3 piece union

Solvent socket

ASTRALPOOL 

	Code	Standard Pack	Standard weight in kg	Standard volume in m ³
Ø 50 mm	32601	30	5.80	0.0204
Ø 63 mm	32602	12	4.44	0.0204
Ø 75 mm	02333	16	8.7	0.0408
Ø 90 mm	02334	12	9.5	0.0408
Ø 110 mm	02335	5	7.6	0.0408



PVC 3 piece union

Female solvent socket & BSP male thread

ASTRALPOOL 

	Code	Standard Pack	Standard weight in kg	Standard volume in m ³
Ø 50 mm x 1½"	32603	30	6.70	0.0204
Ø 63 mm x 2"	32604	12	5.24	0.0204
Ø 50 x 1½" (with o-ring)	07716	30	6.9	0.02
Ø 63 x 2" (with o-ring)	07717	12	4.9	0.02

PVC ball valve PN-12 (eQUA PN12)



DESCRIPTION

HDPE (polythene) ball seat. EPDM O-rings. "Antiblock" system.

	Code	Standard Pack	Standard weight in kg	Standard volume in m ³
Ø 50 mm	41941	10	7.61	0.0204
Ø 63 mm	41942	10	11.80	0.0408



PVC ball valve (STD PN16)

DESCRIPTION

HDPE (polythene) ball seat. EPDM O-rings. "Antiblock" system.

	Code	Standard Pack	Standard weight in kg	Standard volume in m ³
Ø 50 mm	36505	10	7.40	0.0204
Ø 63 mm	36506	10	12.70	0.0408
Ø 75 mm	36507	4	9.2	0.0408
Ø 90 mm	36508	2	7.2	0.0408
Ø 110 mm	36509	1	8.2	0.0408



PVC spring check valve

DESCRIPTION

Spring in stainless steel. EPDM O-rings. Vertical or horizontal installation.

	Code	Standard Pack	Standard weight in kg	Standard volume in m ³
Ø 50 mm	09015	12	7.80	0.0204
Ø 63 mm	09016	10	11.70	0.0408
Ø 75 mm	09017	4	8.5	0.0408
Ø 90 mm	09018	2	7.1	0.0408
Ø 110 mm (DN80)	09019	2	7.6	0.0408

PRESSURE PVC VALVES

3-way rotary disc valve



Manual valves



Automatic valves

DESCRIPTION

3-way rotary disc valve in PVC-U with rotary flap to shut off one port. Can be used in circuits where the working pressure is not above 6 bar (90 psi); includes a lever that shows the closed port.

Sizes: Ø 50-63 mm and Ø 63-75 mm. Available in manual (lever) or automatic (electric actuator) mode. Designed for use in pools and spas. The manual valve can have 2 open ports and 1 shut off, 3 open ports or a partial adjustable opening, whilst the electric actuator can be turned from 90° to 180° and has a 220 VAC or 24 VAC connection.

	Code	Standard Pack	Standard weight in kg	Standard volume in m ³
3-way rotary disc valve solvent socket				
Manual Ø 63-75 mm	41862	4	4.04	0.041
Manual Ø 50-63 mm	15765	8	5.2	0.041
Automatic Ø 50-63 mm. 220 VAC (180°)	41863	1	1.4	0.041
Automatic Ø 63-75 mm. 220 VAC (180°)	59959	1	1.85	0.041
Automatic Ø 50-63 mm. 24 VAC (180°)	45866	1	1.4	0.041
Automatic Ø 63-75 mm. 24 VAC (180°)	59960	1	1.85	0.041
Automatic Ø 63-75 mm. 220 VAC (90°)	41864	1	1.85	0.041
Automatic Ø 63-75 mm. 24 VAC (90°)	43730	1	1.85	0.041

* Ask Cepex Catalogue for automatic ball valves codes

PRESSURE FLUID HANDLING PVC ACCESSORIES

PVC pipe PN-10



	Code	Standard Pack	Standard weight in kg	Standard volume in m ³
Ø 40 mm	02708	5 m	-	-
Ø 50 mm	02709	5 m	45.0	1.14
Ø 63 mm	02710	6 m	72.0	1.40
Ø 75 mm	02711	6 m	-	-
Ø 90 mm	02712	6 m	-	-
Ø 110 mm	02713	6 m	-	-
Ø 125 mm	02714	6 m	-	-
Ø 140 mm	02715	6 m	-	-
Ø 160 mm	02716	6 m	-	-
Ø 180 mm	02717	6 m	-	-
Ø 200 mm	02718	6 m	-	-
Ø 250 mm	02719	6 m	-	-
Ø 315 mm	02720	6 m	-	-



Semi-rigid hose

DESCRIPTION

Made of PVC to glue to pressure fittings using PVC adhesive grey colour.

	Code	Standard Pack	Standard weight in kg	Standard volume in m ³
Ø 16 mm	34587	25 m	3.2	0.030
Ø 16 mm	34586	50 m	6.2	0.040
Ø 20 mm	30754	25 m	4.0	0.040
Ø 20 mm	28570	50 m	9.1	0.060
Ø 25 mm	30755	25 m	6.0	0.050
Ø 25 mm	28571	50 m	11.0	0.042
Ø 32 mm	30756	25 m	9.6	0.070
Ø 32 mm	28572	50 m	16.7	0.065
Ø 40 mm	30757	25 m	12.3	0.110
Ø 40 mm	28573	50 m	23.0	0.109
Ø 50 mm	30758	25 m	18.4	0.150
Ø 50 mm	28574	50 m	37.0	0.178
Ø 63 mm	28575	25 m	49.5	1.140
Ø 75 mm	34588	25 m	33.3	0.300

PVC Solvent



	Code	Standard Pack	Standard weight in kg	Standard volume in m ³
0.125 l	54740	28	4.7	0.026
0.5 l	02432	15	8.1	0.026
1 l	02431	12	11.0	0.036

PVC Glue



	Code	Standard Pack	Standard weight in kg	Standard volume in m ³
0,25 l	02429	30	10.0	0.024
0,50 l	02427	15	8.0	0.026
1 l	02426	12	13.0	0.036
0.50 l with paint brush	09043	-	-	-
1 l with paint brush	09044	-	-	-

PVC Cleaner

DESCRIPTION

Liquid cleaner specially adequate for cleaning and degreasing pipes, coupling sockets and other PVC rigid fittings before gluing them together, and for removing excess glue.



	Code	Standard Pack	Standard weight in kg	Standard volume in m ³
Cleaner 500 ml	57685	-	-	-
Cleaner 1000 ml	57687	-	-	-



Blue Adhesive

extra quick drying for flexible and rigid PVC pipes



DESCRIPTION

For large diameter pressure pipes. Slow setting time, allowing correct positioning of the fittings and perfect cementation.

Supplied with brush.

	Code	Standard Pack	Standard weight in kg	Standard volume in m ³
250 ml	56217	36	11.18	0.02
500 ml	56218	24	13.50	0.02
1000 ml	56221	12	12.90	0.02



Blue Adhesive

extra quick drying for flexible and rigid PVC pipes



DESCRIPTION

Special for pools. For use in pool installations. Its high Gel composition and covering capacity gives perfect cementation. Supplied with brush.

	Code	Standard Pack	Standard weight in kg	Standard volume in m ³
250 ml	57680	36	11.20	0.02
500 ml	57682	24	13.50	0.02
1000 ml	57683	12	12.90	0.02

FILTER RING MANIFOLDS FOR 3/4" LATERALS

8 lateral ring manifold



DESCRIPTION

Made of PVC, inner Ø 50 mm. For 3/4" collector arms.

	Code	Standard Pack	Standard weight in kg	Standard volume in m ³
	00624	12	4.0	0.017

12 lateral ring manifold



DESCRIPTION

Made of PVC, inner Ø 63 mm. For 3/4" collector arms.

	Code	Standard Pack	Standard weight in kg	Standard volume in m ³
	00625	6	3.0	0.310

3/4" laterals



DESCRIPTION

0.3 mm slots.

	Code	Standard Pack	Standard weight in kg	Standard volume in m ³
Length 225 mm	00626	50	2.0	0.017
Length 160 mm	00627	50	2.0	0.017
Length 110 mm	00628	50	2.0	0.008
Length 100 mm (extensions)	00629	50	2.0	0.008

Bush coupling



DESCRIPTION

For laterals. In PVC.

	Code	Standard Pack	Standard weight in kg	Standard volume in m ³
Inside threading 3/4"	00630	50	2.0	0.003

8 lateral ring manifold



DESCRIPTION

Made of PVC, inner Ø 50 mm. For 1" collector arms.

	Code	Standard Pack	Standard weight in kg	Standard volume in m ³
	06433	12	4.0	0.017

12 lateral ring manifold

DESCRIPTION

Made of PVC, inner Ø 63 mm. For 1" collector arms.

	Code	Standard Pack	Standard weight in kg	Standard volume in m ³
	06434	6	3.0	0.310

1" laterals



DESCRIPTION

0.3 mm slots.

	Code	Standard Pack	Standard weight in kg	Standard volume in m ³
Length 225 mm	06435	50	2.0	0.017
Length 160 mm	06436	50	2.0	0.017
Length 110 mm	06437	50	2.0	0.008
Length 100 mm (extensions)	06438	50	2.0	0.008

Bush coupling



DESCRIPTION

For laterals. In PVC.

	Code	Standard Pack	Standard weight in kg	Standard volume in m ³
Inner threading 1"	06439	-	-	-

DIFFUSER FILTER

For Ø 50 mm pipe



	Code	Standard Pack	Standard weight in kg	Standard volume in m ³
	00645	6	1.0	0.009

For Ø 63 mm pipe

	Code	Standard Pack	Standard weight in kg	Standard volume in m ³
	00646	6	2.0	0.023

COLLECTORS FOR VALVE MANIFOLDS

Collector pipe for valve manifold



DESCRIPTION

Made of PVC. Inlet connections, inner Ø 50 mm and 63 mm. Outlet connections Ø 50 and 63 mm.

	Code	Standard Pack	Standard weight in kg	Standard volume in m ³
Connections Ø 50 mm	31877	1	-	-
Connections Ø 63 mm	34407	1	-	-



POOLS

PISCINE
LAGHETTO[®]

430 ABOVE GROUND POOLS - PLAYA

- 432 Playa MINIPOOL
- 433 Playa HEATING & BUBBLES
- 434 Playa LIVING
- 437 Playa accessories

**438 ABOVE GROUND POOLS - PLAYA
TWIN**

**440 ABOVE GROUND POOLS - DOLCE
VITA**

- 444 Dolce Vita RATTAN
- 446 Dolce Vita DIVA
- 448 Dolce Vita DIVA LTI
- 450 Dolce Vita YACHT
- 452 Dolce Vita NAKED
- 454 Dolce Vita accessories

460 ABOVE GROUND POOLS - DIVINA

- 462 DIVINA Infinity model
- 464 DIVINA model

466 ABOVE GROUND POOLS - POP!

- 472 POP!
- 473 POP! accessories

**476 ABOVE GROUND POOLS -
CLASSIC**

ASTRALPOOL 

478 INOXPOOL

- 478 Inoxpool

ABOVE GROUND POOLS - PLAYA

PLAYA

PLAYA is an elegant mini-pool created from the great Italian design.

The gentle hydromassage, the heated water, the pleasantness of the hand woven fibers, invite you to relax in total wellness and allow you to enjoy it both indoors and outside the house. Playa Living is the evolution of Playa model with its soft cushions; it becomes a relaxing oasis, a real "lounge" that decorates the interior of the house or outdoor spaces.



ABOVE GROUND POOLS - PLAYA



Pool liner



LINER

High strength liner in durable polyester and polymer. White color.

STRUCTURE

Hot galvanized coated steel and inox steel structure, powdered epoxy.

AESTHETIC FINISHES

Wicker exterior panels on aluminum frame. Colors: Laghetto white, grey, coffee.

Playa skimmer

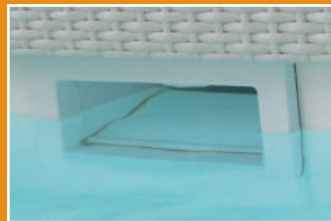

FILTRATION SYSTEM

Laghetto exclusive filtration system and water treatment.

Filtration system composed of:

One wall skimmer complete with pre-filter, cartridge filter and pump.

Included: suction plate and brush for bottom cleaning.

LED spotlight



LED SPOTLIGHT

Small, white, LED spotlight. High brightness spotlight.

Air massage



AIR MASSAGE

Air massage with bubbles. Available only for version: HYDRO & HEATER

HEATING

Water heating. Only for HYDRO & HEATER version.

Sunbed



SUNBED (optional)

Nautical Sky fabric finish available in several colors. Colors: natural, brown, grey, water.

Playa Living elements

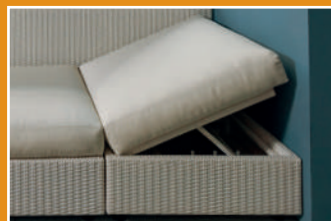

PLAYA LIVING ELEMENTS

Playa Living elements with aluminium structure and wicker panels. Available in several sizes and also with reclinable backrest. Matching cushions with nautical Sky fabric finish.



POOL WARRANTY: 5 YEARS

ACCESSORIES WARRANTY: 2 YEARS

Playa model MINIPOOL version



PLAYA



Sunbed (optional):

Nautical Sky fabric finish available in several colors.

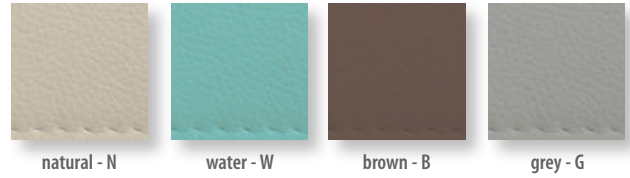

Filtration system composed of:

One wall skimmer complete with pre-filter, cartridge filter, 120 W, 12 V, class 2, synchronous pump with permanent magnet, max. flow 5500 l/h, complete with transformer. Included: suction plate and brush for bottom cleaning.

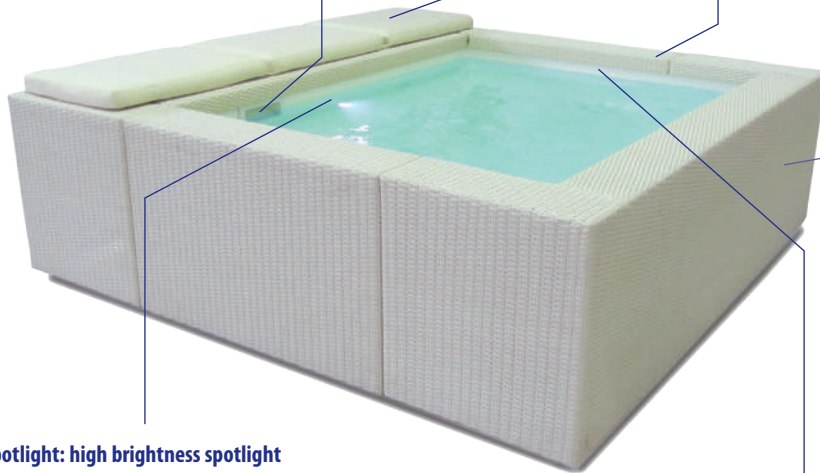

Exterior panels:

Handwoven fiber.



Laghetto white - BI



grey - GR

Liner:



white - BI

LED spotlight: high brightness spotlight

Description	Total dimensions (W x L x H) cm	Water dimensions (W x L x H) cm	Water volume Litres	Packaging dimensions	Total gross weight Kg	N. pallets	Color panel model	Laghetto reference	Code
MiniPool Version. Playa 1 - 220 x 220. SINGLE CASE STRUCTURE - WHITE POOL LINER - 12 V FILTRATION SYSTEM WITH WALL SKIMMER - LED SPOT - WICKER PANELS	220x220x70	180x140x55	1200	80x230x h150	157	1	PLAYA1 WHITE	KITDVPLA1BIBI1G	67339
							PLAYA1 GREY	KITDVPLA1BIGR1G	69349
MiniPool Version. Playa 2 - 320 x 220. SINGLE CASE STRUCTURE - WHITE POOL LINER - 12 V FILTRATION SYSTEM WITH WALL SKIMMER - LED SPOT - WICKER PANELS	220x320x70	180x240x55	2000	80x230x h170	183	1	PLAYA2 WHITE	KITDVPLA2BIBI1G	67341
							PLAYA2 GREY	KITDVPLA2BIGR1G	69351
MiniPool Version. Playa 3 - 420 x 220. SINGLE CASE STRUCTURE - WHITE POOL LINER - 12 V FILTRATION SYSTEM WITH WALL SKIMMER - LED SPOT - WICKER PANELS	220x420x70	180x340x55	3000	80x230x h170	198	1	PLAYA3 WHITE	KITDVPLA3BIBI1G	69356
							PLAYA3 GREY	KITDVPLA3BIGR1G	69358

ABOVE GROUND POOLS - PLAYA

Playa model HEATING & BUBBLES version



PLAYA



Sunbed (optional):

Nautical Sky fabric finish available in several colors.

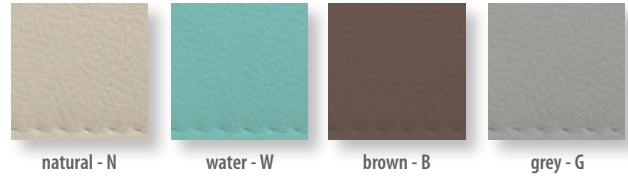

Laghetto filtration system composed of:

One wall skimmer complete with pre-filter and cartridge filter. Included: suction plate and brush for bottom cleaning.
 Technical module self-extinguishing in ABS, including:
 115 W, 220 V, induction circulation pump, max flow 7000 l/h, max prevalence 3 m.
 230 V, 2000 W IPX5 electrical heater.
 Heater max. power: + 15° C granted than the temperature of the version without heater (with isothermic cover installed).
 220 V, 700 W absorption, IPX5 class II, max flow 70mc/h, max pressure 190 mbar, air blower. Class II, 220/12 V 10 VA, Led transformer.
 Control unit complete with keyboard and display (IPX5 protected) for heating, filtration cycles, blower and Led control.

Exterior panels:

Handwoven fiber.

Internal structure

Isothermic cover

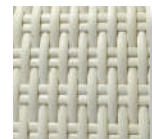
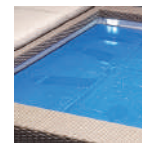

Laghetto white - BI



coffee - CF

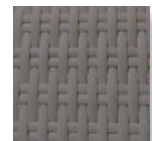

grey - GR

Liner:



white - BI

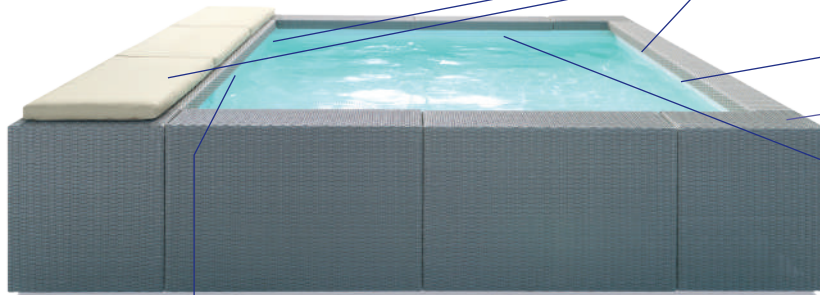

LED spotlight: high brightness spotlight

Description	Total dimensions (W x L x H) cm	Water dimensions (W x L x H) cm	Water volume Litres	Packaging dimensions	Total gross weight Kg	N. pallets	Color panel model	Laghetto reference	Code
Heating & bubbles version. Playa 1 - 220 x 220. SINGLE CASE STRUCTURE - WHITE POOL LINER - FILTRATION SYSTEM - HEATER AND AIR HYDROMASSAGE - LED SPOT - ISOTHERMIC COVER - WICKER PANELS	220x220x70	180x140x55	1200	80x230x h150	172	1	PLAYA1 WHITE	KITDVPLARB1BIB1IG	67343
							PLAYA1 GREY	KITDVPLARB1BIGR1IG	69352
Heating & bubbles version. Playa 2 - 320 x 220. SINGLE CASE STRUCTURE - WHITE POOL LINER - FILTRATION SYSTEM - HEATER AND AIR HYDROMASSAGE - LED SPOT - ISOTHERMIC COVER - WICKER PANELS	220x320x70	180x240x55	2000	80x230x h180	198	1	PLAYA2 WHITE	KITDVPLARB2BIB1IG	67345
							PLAYA2 GREY	KITDVPLARB2BIGR1IG	69354
Heating & bubbles version. Playa 3 - 420 x 220. SINGLE CASE STRUCTURE - WHITE POOL LINER - FILTRATION SYSTEM - HEATER AND AIR HYDROMASSAGE - LED SPOT - ISOTHERMIC COVER - WICKER PANELS	220x420x70	180x340x55	3000	80x230x h180	213	1	PLAYA3 COFFEE	KITDVPLARB3BICF1IG	69361
							PLAYA3 WHITE	KITDVPLARB3BIB1IG	69363
							PLAYA3 GREY	KITDVPLARB3BIGR1IG	69364

POOL WARRANTY: 5 YEARS. ACCESSORIES WARRANTY: 2 YEARS.

Playa LIVING



Playa Living is the evolution of Playa model with its soft cushions; it becomes a relaxing oasis, a real "lounge" that decorates the interior of the house or outdoor spaces.

PLAYA LIVING ELEMENTS

Playa Living elements with aluminium structure and wicker panels.
Available in several sizes and also with reclinable backrest. Matching cushions with nautical Sky fabric finish.



PLAYA LIVING



ACCESSORIES WARRANTY:
2 YEARS

AVAILABLE COLORS

Handwoven fiber

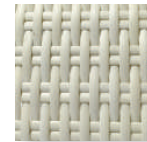

Laghetto white - BI



coffee - CF



grey - GR



Nautical Sky fabric cushions



natural - N



water - W



brown - B



grey - G

AVAILABLE DIMENSIONS (CM)

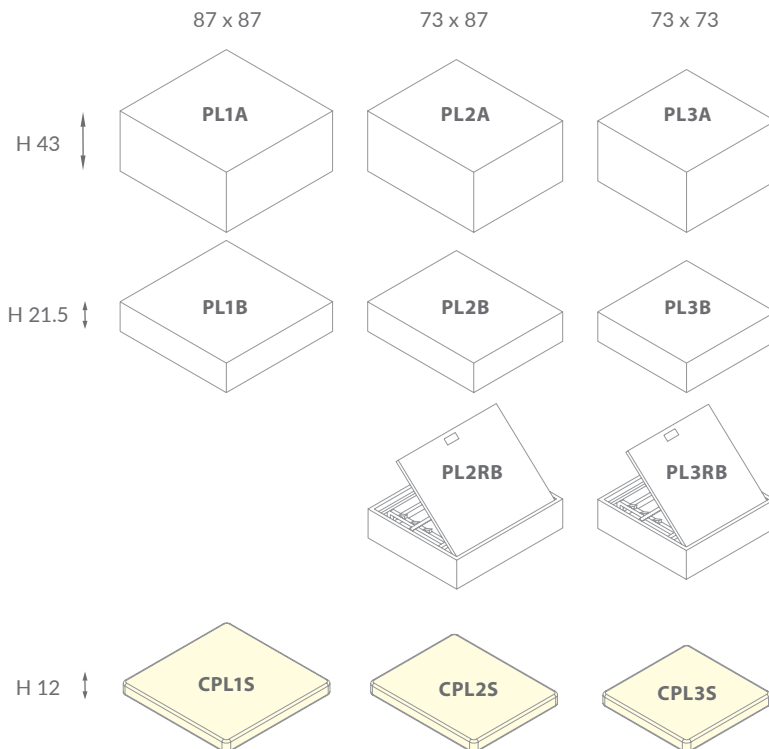

PLAYA LIVING seat element with reclinable backrest

PLAYA LIVING



Configuration examples

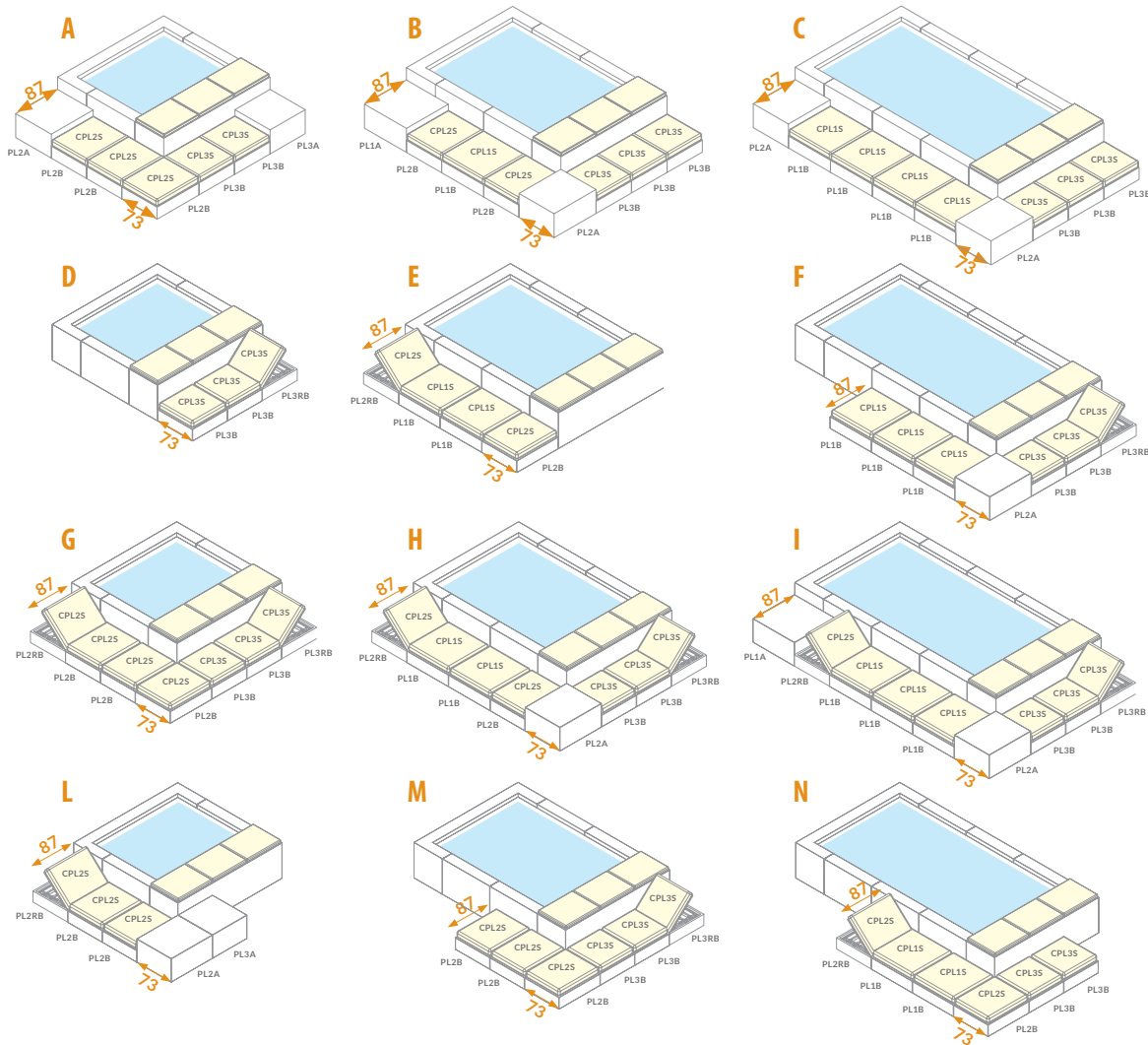

Description

A	PL2B (n.3) + PL2A (n.1) + PL3A (n.1) + PL3B (n.2)	CPL2S (n.3) + CPL3S (n.2)
B	PL1A (n.1) + PL2B (n.2) + PL1B (n.1) + PL2A (n.1) + PL3B (n.3)	CPL2S (n.2) + CPL1S (n.1) + CPL3S (n.3)
C	PL1B (n.4) + PL2A (n.2) + PL3B (n.3)	CPL1S (n.4) + CPL3S (n.3)
D	PL3B (n.2) + PL3RB (n.1)	CPL3S (n.3)
E	PL2RB (n.1) + PL2B (n.1) + PL1B (n.2)	CPL2S (n.2) + CPL1S (n.2)
F	PL3B (n.2) + PL3RB (n.1) + PL1B (n.3) + PL2A (n.1)	CPL3S (n.3) + CPL1S (n.3)
G	PL2RB (n.1) + PL2B (n.3) + PL3B (n.2) + PL3RB (n.1)	CPL2S (n.4) + CPL3S (n.3)
H	PL2RB (n.1) + PL2B (n.1) + PL1B (n.2) + PL2A (n.1) + PL3B (n.2) + PL3RB (n.1)	CPL2S (n.2) + CPL1S (n.2) + CPL3S (n.3)
I	PL2RB (n.1) + PL1B (n.3) + PL2A (n.1) + PL3B (n.2) + PL3RB (n.1) + PL1A (n.1)	CPL2S (n.1) + CPL1S (n.3) + CPL3S (n.3)
L	PL2RB (n.1) + PL2B (n.2) + PL2A (n.1) + PL3A (n.1)	CPL2S (n.3)
M	PL2B (n.3) + PL3B (n.2) + PL3RB (n.1)	CPL2S (n.3) + CPL3S (n.3)
N	PL2RB (n.1) + PL1B (n.2) + PL2B (n.1) + PL3B (n.2)	CPL2S (n.2) + CPL1S (n.2) + CPL3S (n.2)

PLAYA LIVING - Elements



PLAYA LIVING

Description	Total dimensions (W x L x H) cm	Total gross weight Kg	Number of packages	Color model	Laghetto reference	Code
Structure 87X87 43 cm Coffe Playa Living	87x87 h.43	10	1	COFFEE	PL1aCF	PL1ACF
Structure 87X87 43 cm White Playa Living	87x87 h.43	10	1	WHITE	PL1aBI	PL1ABI
Structure 87X87 43 cm Grey Playa Living	87x87 h.43	10	1	GREY	PL1aGR	PL1AGR
Structure 73X87 43 cm Coffe Playa Living	73x87 h.43	9	1	COFFEE	PL2aCF	PL2ACF
Structure 73X87 43 cm White Playa Living	73x87 h.43	9	1	WHITE	PL2aBI	PL2ABI
Structure 73X87 43 cm Grey Playa Living	73x87 h.43	9	1	GREY	PL2aGR	PL2AGR
Structure 73X73 43 cm Coffe Playa Living	73x73 h.43	8	1	COFFEE	PL3aCF	PL3ACF
Structure 73X73 43 cm White Playa Living	73x73 h.43	8	1	WHITE	PL3aBI	PL3ABI
Structure 73X73 43 cm Grey Playa Living	73x73 h.43	8	1	GREY	PL3aGR	PL3AGR
Structure 87X87 21.5 cm Coffe Playa Living	87x87 h.21,5	9	1	COFFEE	PL1bCF	PL1BCF
Structure 87X87 21.5 cm White Playa Living	87x87 h.21,5	9	1	WHITE	PL1bBI	PL1BBI
Structure 87X87 21.5 cm Grey Playa Living	87x87 h.21,5	9	1	GREY	PL1bGR	PL1BGR
Structure 73X87 21.5 cm Coffe Playa Living	73x87 h.21,5	8	1	COFFEE	PL2bCF	PL2BCF
Structure 73X87 21.5 cm White Playa Living	73x87 h.21,5	8	1	WHITE	PL2bBI	PL2BBI
Structure 73X87 21.5 cm Grey Playa Living	73x87 h.21,5	8	1	GREY	PL2bGR	PL2BGR
Structure 73X73 21.5 cm Coffe Playa Living	73x73 h.21,5	7	1	COFFEE	PL3bCF	PL3BCF
Structure 73X73 21.5 cm White Playa Living	73x73 h.21,5	7	1	WHITE	PL3bBI	PL3BBI
Structure 73X73 21.5 cm Grey Playa Living	73x73 h.21,5	7	1	GREY	PL3bGR	PL3BGR
Seat element with reclinable backrest	73x87 h.21.5	8	1	Laghetto white	PL2RBB	PL2RBBI
Seat element with reclinable backrest	73x87 h.21.5	8	1	Grey	PL2RBG	PL2RBGR
Seat element with reclinable backrest	73x87 h.21.5	8	1	Coffee	PL2RBC	PL2RBCF
Seat element with reclinable backrest	73x73 h.21.5	7	1	Laghetto white	PL3RBB	PL3RBBI
Seat element with reclinable backrest	73x73 h.21.5	7	1	Grey	PL3RBG	PL3RBGR
Seat element with reclinable backrest	73x73 h.21.5	7	1	Coffee	PL3RBC	PL3RBCF
Cushion 87X87 12 cm Natural Playa Living	87x87 h.12	3	1	NATURAL	CPL1SN	CPL1SN
Cushion 87X87 12 cm Water Playa Living	87x87 h.12	3	1	WATER	CPL1SW	CPL1SW
Cushion 87X87 12 cm Brown Playa Living	87x87 h.12	3	1	BROWN	CPL1SB	CPL1SB
Cushion 87X87 12 cm Grey Playa Living	87x87 h.12	3	1	GREY	CPL1SG	CPL1SG
Cushion 73X87 12 cm Natural Playa Living	73x87 h.12	3	1	NATURAL	CPL2SN	CPL2SN
Cushion 73X87 12 cm Water Playa Living	73x87 h.12	3	1	WATER	CPL2SW	CPL2SW
Cushion 73X87 12 cm Brown Playa Living	73x87 h.12	3	1	BROWN	CPL2SB	CPL2SB
Cushion 73X87 12 cm Grey Playa Living	73x87 h.12	3	1	GREY	CPL2SG	CPL2SG
Cushion 73X73 12 cm Natural Playa Living	73x73 h.12	2	1	NATURAL	CPL3SN	CPL3SN
Cushion 73X73 12 cm Water Playa Living	73x73 h.12	2	1	WATER	CPL3SW	CPL3SW
Cushion 73X73 12 cm Brown Playa Living	73x73 h.12	2	1	BROWN	CPL3SB	CPL3SB
Cushion 73X73 12 cm Grey Playa Living	73x73 h.12	2	1	GREY	CPL3SG	CPL3SG

Playa accessories



PLAYA

Description	Packaging dimensions	Total gross weight Kg	Number of packages	Laghetto reference	Code
Playa 1 - 220x220 cm - standard cover	30x30x h15	3	1	CODVPLA1	67346
Playa 2 - 220x320 cm - standard cover	30x30x h15	3	1	CODVPLA2	67348
Playa 3 - 220x420 cm - standard cover	30x30x h15	4	1	CODVPLA3	69408
Sunbed Nautical Sky fabric finish - natural color	60x70x h25	3	1	DVPLALPSN	67347
Sunbed Nautical Sky fabric finish - water color	60x70x h25	3	1	DVPLALPSW	68616
Sunbed Nautical Sky fabric finish - brown color	60x70x h25	3	1	DVPLALPSB	69405
Sunbed Nautical Sky fabric finish - grey color	60x70x h25	3	1	DVPLALPSG	69407
Playa 1 isothermic foldable cover	60x70x h50	2	1	COGIDVPLA11G	70889
Playa 2 isothermic foldable cover	60x70x h50	2	1	COGIDVPLA21G	70890
Playa 3 isothermic foldable cover	60x70x h50	3	1	COGIDVPLA31G	70891

Sky Nautical fabric finish

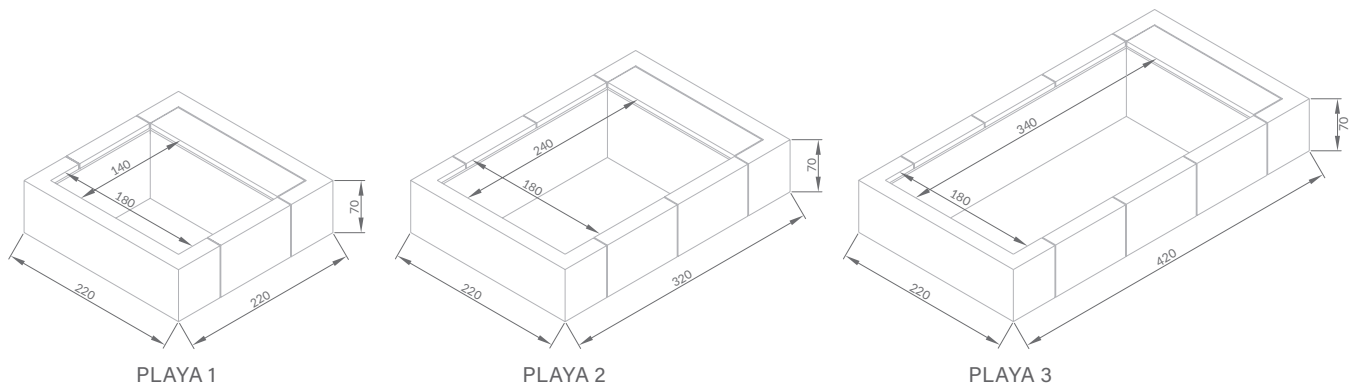
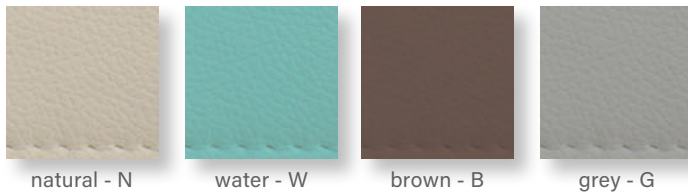

Model	Box	Water size (m)	General dimensions (m)	Water height (cm)	Total height (cm)	Volume (l)
PLAYA1	1	1.40 x 1.80	2.20 x 2.20	55	70	1200
PLAYA2	1	2.40 x 1.80	3.20 x 2.20	55	70	2000
PLAYA3	1	3.40 x 1.80	4.20 x 2.20	55	70	3000

ABOVE GROUND POOLS - PLAYA TWIN

PLAYA TWIN



Playa Twin is the new concept of a design mini-pool, created by the Italian style and elegance. This version is enriched with a double sunbathing area over the two twin lockers, and two deck chairs that can become the cover of the mini-pool itself, when not used.

The rattan panels are proposed in two colors, Laghetto White and Grey and it is equipped with heater and bubbles system.

FEATURES

- ▶ Size: ONLY 1 SIZE - only heater and Bubbles version
- ▶ Color: Laghetto White.
- ▶ Filtration: cartridge and wall skimmer



Description	Laghetto reference	Code
WHITE	KITPLATW1BIBI	-
GREY	KITPLATW1BIGR	-



ABOVE GROUND POOLS - DOLCE VITA

Dolce Vita

A pool that looks good in any environment and that you can build even where a traditional inground swimming pool can't be placed.

DolceVita is the most fashionable and desirable pool for those people who search something to stand out and who setup a space dedicated to the pleasure and the family relaxation.



DIVA - RATTAN

MOD.	WATER SIZE (m)	TOTAL ENCUMBRANCE (m)	WATER HEIGHT (m)	TOTAL HEIGHT (m)	VOLUME (m ³)
24	2 x 4	2.4 x 4.4	1.2	1.3	9.6
25	2 x 5	2.4 x 5.4	1.2	1.3	12
35	3 x 5	3.4 x 5.4	1.2	1.3	18
36	3 x 6	3.4 x 6.4	1.2	1.3	21.6
37	3 x 7	3.4 x 7.4	1.2	1.3	25.2
48	4 x 8	4.4 x 8.4	1.2	1.3	38.4
49	4 x 9	4.4 x 9.4	1.2	1.3	43.2
510	5 x 10	5.4 x 10.4	1.2	1.3	60

Special sizes are available on demand.

DIVA LTI - DIVINA (only in size 35, 36, 37, 48)

MOD.	WATER SIZE (m)	TOTAL ENCUMBRANCE (m)	WATER HEIGHT (m)	TOTAL HEIGHT (m)	VOLUME (m ³)
35	3 x 5	3.4 x 6.1	1.2	1.3	18
36	3 x 6	3.4 x 7.1	1.2	1.3	21.6
37	3 x 7	3.4 x 8.1	1.2	1.3	25.2
48	4 x 8	4.4 x 9.1	1.2	1.3	38.4
49	4 x 9	4.4 x 10.10	1.2	1.3	43.2

Available in 2.5 - 3 - 4 m. width only.

ABOVE GROUND POOLS - DOLCE VITA

Dolce Vita

FEATURES:

Dolcevita renews the world of above-ground pools thanks to a sound technology Laghetto which is on the market for over 40 years, and its innovative and graceful design.

Dolcevita can adapt to the needs of a changing family, allowing thoughts, repositioning, moving, resale.

Its versatility allows easy and quick installation even in areas with seasonal permits only.

Dolcevita provides a recirculating and filtration system which enables the highest quality and hygiene of the water purity.

Dolcevita comes up in two different models: Diva and Rattan, with high quality materials that ensure long time use.

Structure

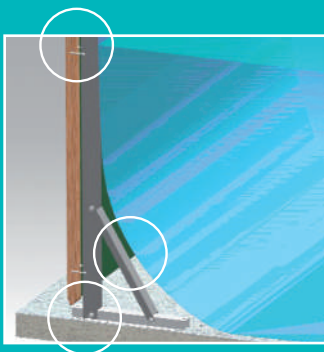

Pool liner



Plastic Wood Coping (RATTAN line)



TRELLIS PILLARS

Powder coated hot galvanized steel with stainless steel piece of support.

TRELLIS SPARS

Powder coated hot galvanized steel.

NUTS AND BOLTS

Stainless steel with anti-grip nuts.

LINER

Made of PVC coated polyester fabric membrane it is incredibly strong (it easily passes DIN 53354 test up to traction of 430 Kg on 5 cm), it is treated with a special coating that prevents dirt from attaching to exposed areas and provides protection against damage caused by UV light to be very durable.

DOLCEVITA TOPRAIL FINISH

Rattan top rail finish is a dedicated composite wood made for us exclusively by Plastic Wood. Diva top rail finish is integrated in the design of the special wicker panel.

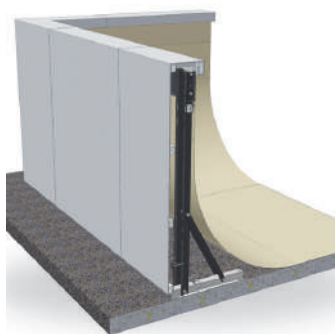

white



beige



light blue

Warranty on the pool (liner + structural parts) is 5 years, warranty on all the other accessories included in the kit is 2 years.



ABOVE GROUND POOLS - DOLCE VITA

Dolce Vita

Diva panel



DolceVita Diva ladder

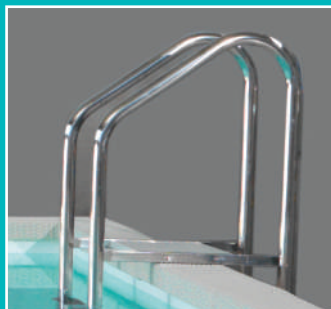

Laghetto Led Spot



Vacuum cleaner



DOLCEVITA PANELS

DolceVita 2020 finish is available in 2 different panels options: wicker with wicker corner pieces for the Rattan line, or the exclusive solution created for the DIVA line, where the Viro wicker panels also cover the top rail of the structure.

DOLCEVITA LADDERS

The DolceVita finishes have two different kinds of ladder to access to the pool.
Rattan kit include a ladder with the liftable external part to avoid the access to the kids when the pool is unattended or unused.
DIVA kit has a dedicated luxury grade ladder.

LED SPOT LIGHTS

Every DolceVita, no matter what finish, comes standard with Laghetto Led spot lights.
These led spot lights have a peerless luminous efficiency, very low power consumption (less than 8 W) and an unmatched durability.

VACUUM CLEANER

Every DolceVita Pool kit also include a vacuum cleaner (pipe length varies according to the pool size and the number of skimmers).

ABOVE GROUND POOLS - DOLCE VITA

Dolce Vita



AstralPool sand filters



Winter cover

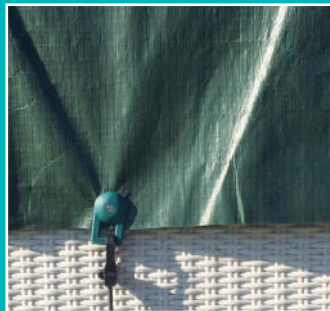

Summer cover



SAND FILTRATION SYSTEMS

The technical partnership between Piscine Laghetto and AstralPool introduces the 6, 10 and 15 mc/h sand filters in all swimming pool kits.

WINTER COVER (optional)

Winter cover LSP complete with elastic cords and fixations.

SUMMER COVER (optional)

Isothermic summer cover for DolceVita.

DOLCEVITA Rattan model

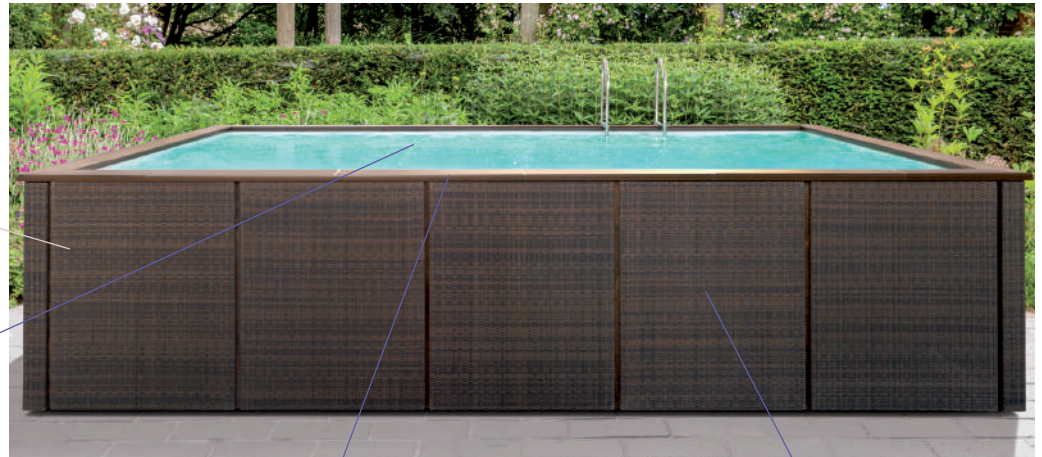

1
Internal structure

2
Pool liner



white



beige



light blue

5
DolceVita Composite Wood Top Edge



Tobacco

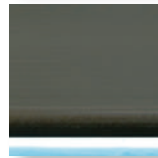

Ardesia

6
Exterior panels:
handwoven fiber



coffee



grey

3
Filtration System (as in the diagram)
attention: the filtration system doesn't
include the electrical panel.



AstralPool sand filters

4
High brightness LED spotlight:
1 Spot until model 36,
2 Spots from model 37 until model 510
(standard placement - see page 459).

7
Vacuum cleaner system.

8
Wooden panel supports and wicker
corner pieces.

9
Overflow system.

10
DolceVita safety ladder.

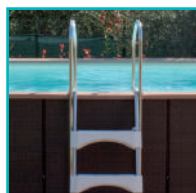

POOL KIT

$$= 1 + 2 + 3 + 4 + 5 + 6 + 7 + 8 + 9 + 10$$



WICKER PANELS AND CORNER PIECES AVAILABLE
IN TWO COLORS: COFFEE OR GREY, POOL LINER
(COLOR CHOICE: LIGHT BLUE, SAND OR WHITE)

- x =
- BICF** (white liner and coffee panels)
 - BIGR** (white liner and grey panels)
 - BECF** (beige liner and coffee panels)
 - BEGR** (beige liner and grey panels)
 - AZCF** (light blue liner and coffee panels)
 - AZGR** (light blue liner and grey panels)



ATTENTION: ONLY AVAILABLE AS COMPLETE KIT -
HALF-METER MEASURES NOT AVAILABLE.

DOLCEVITA Rattan model



Dolce Vita

Laghetto model	Description	Total dimensions (W x L x H) cm	Water dimensions (W x L x H) cm	Water volume Litres	Packaging dimensions	Total gross weight Kg	Laghetto reference	Code
RATTAN 24	Swimming pool 2 x 4 m DOLCEVITA Rattan with sand filter 10 m ³ / h, 1 LED spotlight	240x440	200x400x120	9,600	1 pallet: 100 x 130 x 240 h	357	KITDVC24xS10R	2410X
RATTAN 25	Swimming pool 2 x 5 m DOLCEVITA Rattan with sand filter 10 m ³ / h, 1 LED spotlight	240x540	200x500x120	12,000	1 pallet: 100 x 130 x 240 h	386	KITDVC25xS10R	2510X
RATTAN 35	Swimming pool 3 x 5 m DOLCEVITA Rattan with sand filter 10 m ³ / h, 1 LED spotlight	340x540	300x500x120	18,000	1 pallet: 100 x 130 x 240 h	432	KITDVC35xS10R	3510X
RATTAN 36	Swimming pool 3 x 6 m DOLCEVITA Rattan with sand filter 10 m ³ / h, 1 LED spotlight	340x640	300x600x120	21,600	2 pallets: 100 x 130 x 200 h 100 x 120 x 110 h	565	KITDVC36xS10R	3610X
RATTAN 37	Swimming pool 3 x 7 m DOLCEVITA Rattan with sand filter 10 m ³ / h, 2 LED spotlights	340x740	300x700x120	25,200	2 pallets: 100 x 130 x 240 h 100 x 120 x 135 h	575	KITDVC37xS10R	3710X
RATTAN 48	Swimming pool 4 x 8 m DOLCEVITA Rattan with sand filter 10 m ³ / h, 2 LED spotlights	440x840	400x800x120	38,400	2 pallets: 100 x 130 x 240 h 100 x 120 x 140 h	645	KITDVC48xS10R	4810X
RATTAN 49	Swimming pool 4 x 8 m DOLCEVITA Rattan with sand filter 15 m ³ / h, 2 LED spotlights	440x940	400x900x120	43,200	2 pallets: 100 x 130 x 240 h 100 x 120 x 200 h	720	KITDVC49xS15R	4915X
RATTAN 510	Swimming pool 5 x 10 m DOLCEVITA Rattan with sand filter 15 m ³ / h, 2 LED spotlights	540x1040	500x1000x120	60,000	2 pallets: 100 x 130 x 240 h 100 x 120 x 210 h	860	KITDVC510xS15R	51015X

Substitute **X** for the following 4 letters, according to the desired color combination:

BICF white liner and coffee panels
BIGR white liner and grey panels
BECF beige liner and coffee panels
BEGR beige liner and grey panels

AZCF light blue liner and coffee panels
AZGR light blue liner and grey panels



1
Internal structure

2
Pool liner



white



beige



light blue

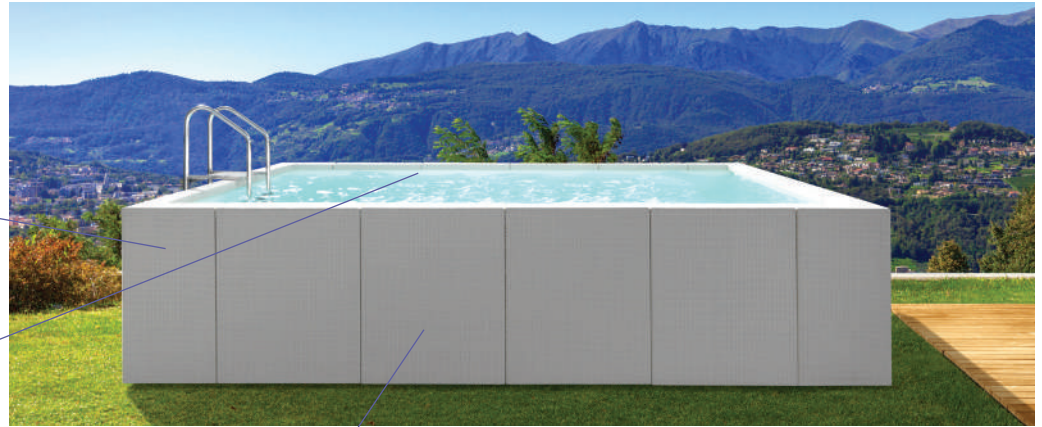

5
Panels with integrated top edge

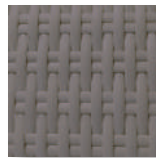
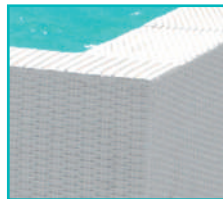

grey

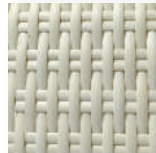

Laghetto white

POOL KIT

$$= 1 + 2 + 3 + 4 + 5 + 6 + 7 + 8 + 9$$

ATTENTION: ONLY AVAILABLE AS COMPLETE KIT. HALF-METER MEASURES NOT AVAILABLE.

3
Filtration System (as in the diagram)
attention: the filtration system doesn't include the electrical panel.



AstralPool sand filters

4
High brightness LED spotlight:
1 Spot until model 36,
2 Spots from model 37 until model 510
(standard placement - see page 459).

6
Vacuum cleaner system.

7
Wooden & steel panels-supports.

8
Overflow system.

9
Luxury ladder specific for Diva version.



ATTENTION!
PANELS AND TOP EDGE INTEGRATED IN ONE PIECE MADE OF WICKER. AVAILABLE IN THREE COLORS: COFFEE, GREY OR LAGHETTO WHITE. POOL LINER (COLOR CHOICE: LIGHT BLUE, SAND OR WHITE)

- x =**
- BIGR** (white liner and grey panels)
 - BIBI** (white liner and white panels)
 - BEGR** (beige liner and grey panels)
 - BEBI** (beige liner and white panels)
 - AZGR** (light blue liner and grey panels)
 - AZBI** (light blue liner and white panels)

DOLCEVITA DIVA model



Dolce Vita

Laghetto model	Description	Total dimensions (W x L x H) cm	Water dimensions (W x L x H) cm	Water volume Litres	Packaging dimensions cm	Total gross weight Kg	Laghetto reference	Code
DIVA 24	Swimming pool 2 x 4 m DOLCEVITA Diva with sand filter 10 m ³ / h, 1 LED spotlight	240x440	200x400x120	9,600	2 pallets: 100 x 130 x 240 h 100 x 120 x 120 h	332	KITDVC24XS10D	D24XS10
DIVA 25	Swimming pool 2 x 5 m DOLCEVITA Diva with sand filter 10 m ³ / h, 1 LED spotlight	240x540	200x500x120	12,000	2 pallets: 100 x 130 x 240 h 100 x 120 x 120 h	356	KITDVC25XS10D	D25XS10
DIVA 35	Swimming pool 3 x 5 m DOLCEVITA Diva with sand filter 10 m ³ / h, 1 LED spotlight	340x540	300x500x120	18,000	2 pallets: 100 x 130 x 240 h 100 x 120 x 180 h	389	KITDVC35XS10D	D35XS10
DIVA 36	Swimming pool 3 x 6 m DOLCEVITA Diva with sand filter 10 m ³ / h, 1 LED spotlight	340x640	300x600x120	21,600	2 pallets: 100 x 130 x 240 h 100 x 110 x 180 h	435	KITDVC36XS10D	D36XS10
DIVA 37	Swimming pool 3 x 7 m DOLCEVITA Diva with sand filter 10 m ³ / h, 2 LED spotlights	340x740	300x700x120	25,200	2 pallets: 100 x 130 x 240 h 100 x 110 x 190 h	472	KITDVC37XS10D	D37XS10
DIVA 48	Swimming pool 4 x 8 m DOLCEVITA Diva with sand filter 10 m ³ / h, 2 LED spotlights	440x840	400x800x120	38,400	2 pallets: 100 x 130 x 250 h 100 x 120 x 190 h	636	KITDVC48XS10D	D48XS10
DIVA 49	Swimming pool 4 x 9 m DOLCEVITA Diva with sand filter 15 m ³ / h, 2 LED spotlights	440x940	400x900x120	43,200	2 pallets: 100 x 130 x 240 h 100 x 120 x 220 h	680	KITDVC49XS15D	D49XS15
DIVA 510	Swimming pool 5 x 10 m DOLCEVITA Diva with sand filter 15 m ³ / h, 2 LED spotlights	540x1040	500x1000x120	60,000	3 pallets: 100 x 130 x 170 h 100 x 120 x 170 h 100 x 120 x 220 h	750	KITDVC510XS15D	D510XS15

Substitute **X** for the following 4 letters, according to the desired color combination:

BIGR white liner and grey panels

BEBI beige liner and white panels

BIBI white liner and white panels

AZGR light blue liner and grey panels

BEGR beige liner and grey panels

AZBI light blue liner and white panels

DOLCEVITA DIVA LTI model



1
Internal structure

2
Pool liner



white



beige



light blue

5
Panels with integrated top edge

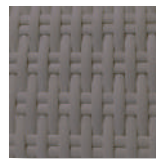

grey

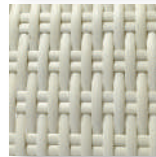

Laghetto white

POOL KIT

$$= 1 + 2 + 3 + 4 + 5 + 6 + 7 + 8 + 9$$

3
Filtration System (as in the diagram)
attention: the filtration system doesn't include the electrical panel.



AstralPool sand filters

6
Vacuum cleaner system.

7
Wooden & steel panels-supports.

8
Overflow system.

9
Luxury ladder specific for Diva version.



4
High brightness LED spotlight:
1 Spot until model 36,
2 Spots from model 37 until model 510
(standard placement - see page 459).



ATTENTION: ONLY AVAILABLE AS COMPLETE KIT - HALF-METER MEASURES NOT AVAILABLE.

CAUTION: THE EQUIPMENT ROOM IS NOT LOADBEARING. NO PERSONS ALLOWED ON IT.



PANELS AND TOP EDGE INTEGRATED IN ONE PIECE MADE OF WICKER. AVAILABLE IN THREE COLORS: COFFEE, GREY OR LAGHETTO WHITE. POOL LINER (COLOR CHOICE: LIGHT BLUE, SAND OR WHITE)

x =

- BIGR** (white liner and grey panels)
- BIBI** (white liner and white panels)
- BEGR** (beige liner and grey panels)
- BEBI** (beige liner and white panels)
- AZGR** (light blue liner and grey panels)
- AZBI** (light blue liner and white panels)

ABOVE GROUND POOLS - DOLCE VITA

DOLCEVITA DIVA LTI model



Dolce Vita

Laghetto model	Description	Total dimensions (W x L x H) cm	Water dimensions (W x L x H) cm	Water volume Litres	Packaging Dimensions	Total gross weight Kg	Laghetto reference	Code
LTI 35	Swimming pool 3 x 5 m DOLCEVITA Diva LTI with sand filter 10 m ³ / h, 1 LED spotlight	340x610	300x500x120	18,000	2 pallets: 100 x 130 x 240 h 100 x 120 x 200 h	410	KITDVC35xS10DG	D35XS10L
LTI 36	Swimming pool 3 x 6 m DOLCEVITA Diva LTI with sand filter 10 m ³ / h, 1 LED spotlight	340x710	300x600x120	21,600	2 pallets: 100 x 130 x 240 h 100 x 120 x 200 h	455	KITDVC36xS10DG	D36XS10L
LTI 37	Swimming pool 3 x 7 m DOLCEVITA Diva LTI with sand filter 10 m ³ / h, 2 LED spotlights	340x810	300x700x120	25,200	2 pallets: 100 x 130 x 240 h 100 x 120 x 210 h	492	KITDVC37xS10DG	D37XS10L
LTI 48	Swimming pool 4 x 8 m DOLCEVITA Diva LTI with sand filter 10 m ³ / h, 2 LED spotlights	440x910	400x800x120	38,400	2 pallets: 100 x 130 x 250 h 100 x 120 x 230 h	675	KITDVC48xS10DG	D48XS10L
LTI 49	Swimming pool 4 x 9 m DOLCEVITA Diva LTI with sand filter 15 m ³ / h, 2 LED spotlights	440x1010	400x900x120	43,200	2 pallets: 100 x 150 x 240 h 100 x 120 x 240 h	700	KITDVC49xS15DG	D49XS15L

Substitute **X** for the following 4 letters, according to the desired color combination:

BIGR	white liner and grey panels	BEBI	beige liner and white panels
BIBI	white liner and white panels	AZGR	light blue liner and grey panels
BEGR	beige liner and grey panels	AZBI	light blue liner and white panels

DOLCEVITA YACHT model



1
Yacht ladder & platform
in composite
wood + Inox ladder



frassino

4
Internal structure

9
Plexiglass parapets

10
Pool liner



white



5
Panels and top edge integrated in one
piece panel made of wicker. Including
2 opening panels on both sides of the
platform.



Laghetto white

2
Filtration System (as in the diagram)
attention: the filtration system doesn't include
the electrical panel.



AstralPool sand filters

6
Hight brightness LED spotlight:
1 Spot until model 36,
2 Spots from model 37 until model 510
(standard placement - see page 459).



7
Vacuum cleaner system.



8
Overflow system.

POOL KIT

$$= 1 + 2 + 3 + 4 + 5 + 6 + 7 + 8 + 9 + 10$$

ATTENTION: ONLY AVAILABLE AS COMPLETE KIT - HALF-METER MEASURES NOT AVAILABLE.

PANELS AND TOP EDGE INTEGRATED IN ONE PIECE MADE OF WICKER. AVAILABLE LAGHETTO WHITE. POOL LINER (COLOR WHITE)

x = BIBI (white liner and Laghetto white panels)

ABOVE GROUND POOLS - DOLCE VITA

DOLCEVITA YACHT model



Dolce Vita

Laghetto model	Description	Total dimensions (W x L x H) cm	Water dimensions (W x L x H) cm	Water volume Litres	Laghetto reference	Code
24	Swimming pool 2 x 4 m DOLCEVITA Yacht with sand filter 6 m ³ / h, 1 LED spotlight	240x635	200x400x120	9,600	KITDVC24xS6Y	D24xS6Y
25	Swimming pool 2 x 5 m DOLCEVITA Yacht with sand filter 6 m ³ / h, 1 LED spotlight	240x735	200x500x120	12,000	KITDVC25xS6Y	D25xS6Y
35	Swimming pool 3 x 5 m DOLCEVITA Yacht with sand filter 6 m ³ / h, 1 LED spotlight	340x735	300x500x120	18,000	KITDVC35xS6Y	D35xS6Y
35	Swimming pool 3 x 5 m DOLCEVITA Yacht with sand filter 10 m ³ / h, 1 LED spotlight	340x735	300x500x120	18,000	KITDVC35xS10Y	D35xS10Y
36	Swimming pool 3 x 6 m DOLCEVITA Yacht with sand filter 6 m ³ / h, 1 LED spotlight	340x835	300x600x120	21,600	KITDVC36xS6Y	D36xS6Y
36	Swimming pool 3 x 6 m DOLCEVITA Yacht with sand filter 10 m ³ / h, 1 LED spotlight	340x835	300x600x120	21,600	KITDVC36xS10Y	D36xS10Y
37	Swimming pool 3 x 7 m DOLCEVITA Yacht with sand filter 10 m ³ / h, 2 LED spotlights	340x935	300x700x120	25,200	KITDVC37xS10Y	D37xS10Y
38	Swimming pool 3 x 8 m DOLCEVITA Yacht with sand filter 10 m ³ / h, 2 LED spotlights	340x1035	300x800x120	28,800	KITDVC38xS10Y	D38xS10Y

Substitute **X** for the 4 following letters, according to the desired color combination:

BIBI white liner and white panels

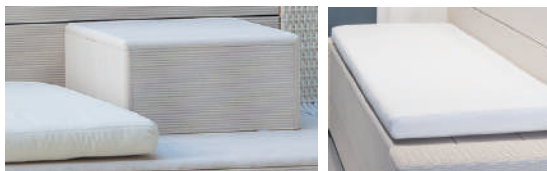

Description	Total dimensions (W x L x H) cm	Laghetto reference	Code
Optional step for easy access - Frassino color	-	DVYGRACOMB	71410
Nautical sky sun bed. Other sizes on request.	200 x 56 x 6	DVYVELA3	71412

DOLCEVITA NAKED model

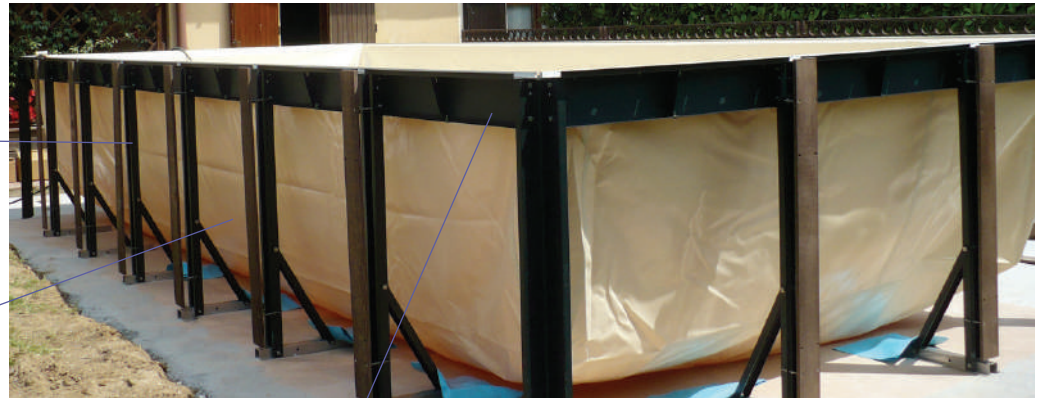

1
Internal structure

2
Pool liner



5
Dolcevita Composite Wood Top Edge

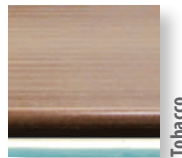

3
Filtration System (as in the diagram)
attention: the filtration system doesn't include the electrical panel.



AstralPool sand filters

4
Hight brightness LED spotlight:
1 Spot until model 36,
2 Spots from model 37 until model 510
(standard placement - see page 459).

6
Vacuum cleaner system.

7
Wooden panel-supports.

8
Overflow system.

9
Dolcevita safety ladder.

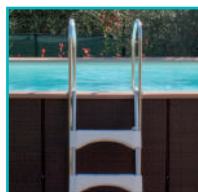

POOL KIT

$$= 1 + 2 + 3 + 4 + 5 + 6 + 7 + 8 + 9$$

ATTENTION: ONLY AVAILABLE AS COMPLETE KIT

ATTENTION:
POOL LINER - COLOR CHOICE.

x =
AZ Dark blue
BE Beige
BI White

DOLCEVITA NAKED model



Dolce Vita

Laghetto model	Description	Total dimensions (W x L x H) cm	Water dimensions (W x L x H) cm	Water volume Litres	Packaging Dimensions	Total gross weight Kg	Laghetto reference	Code
DV NAKED 24	Swimming pool 2 x 4 m DOLCEVITA Naked with sand filter 10 m ³ / h, 1 LED spotlight	240x440	200x400x120	9,600	1 pallet: 100x130x240	357	KITDVC24xS10N	D24xS10Nz
DV NAKED 25	Swimming pool 2 x 5 m DOLCEVITA Naked with sand filter 10 m ³ / h, 1 LED spotlight	240x540	200x500x120	12,000	1 pallet: 100x130x240	386	KITDVC25xS10N	D25xS10Nz
DV NAKED 35	Swimming pool 3 x 5 m DOLCEVITA Naked with sand filter 10 m ³ / h, 1 LED spotlight	340x540	300x500x120	18,000	1 pallet: 100x130x240	432	KITDVC35xS10N	D35xS10Nz
DV NAKED 36	Swimming pool 3 x 6 m DOLCEVITA Naked with sand filter 10 m ³ / h, 1 LED spotlight	340x640	300x600x120	21,600	1 pallet: 100x130x240	565	KITDVC36xS10N	D36xS10Nz
DV NAKED 37	Swimming pool 3 x 7 m DOLCEVITA Naked with sand filter 10 m ³ / h, 2 LED spotlights	340x740	300x700x120	25,200	1 pallet: 100x130x240	575	KITDVC37xS10N	D37xS10Nz
DV NAKED 48	Swimming pool 4 x 8 m DOLCEVITA Naked with sand filter 10 m ³ / h, 2 LED spotlights	440x840	400x800x120	38,400	1 pallet: 100x130x240	645	KITDVC48xS10N	D48xS10Nz
DV NAKED 49	Swimming pool 4 x 9 m DOLCEVITA Naked with sand filter 15 m ³ / h, 2 LED spotlights	440x940	400x900x120	43,200	2 pallets: 100x130x240 100x120x130	720	KITDVC49xS15N	D49xS10Nz
DV NAKED 510	Swimming pool 5 x 10 m DOLCEVITA Naked with sand filter 15 m ³ / h, 2 LED spotlights	540x1040	500x1000x120	60,000	2 pallets: 100x130x240 100x120x130	860	KITDVC510xS15N	D510xS10Nz

STRUCTURE AND POOL LINER

Substitute **x** for the 2 following letters, according to the desired color combination:

- AZ** Light blue
- BE** Sand
- BI** White

COMPOSITE WOOD TOP EDGE ELEMENT

Substitute **z** for the following letters, according to the desired color combination:

- T** Tobacco

DOLCEVITA accessories - Covers



Dolce Vita

SUMMER COVER



WINTER COVER



Description	Total dimensions (W x L x H) cm	Laghetto reference	Code
Winter protection cover with elastic tensioners and DOLCEVITA 2x4 fixings	320 x 520	CODVC24	69644
Winter protection cover with elastic tensioners and DOLCEVITA 2x5 fixings	320 x 620	CODVC25	69645
Winter protection cover with elastic tensioners and DOLCEVITA 3x5 fixings	420 x 620	CODVC35	68001
Winter protection cover with elastic tensioners and DOLCEVITA 3x6 fixings	420 x 720	CODVC36	69646
Winter protection cover with elastic tensioners and DOLCEVITA 3x7 fixings	420 x 820	CODVC37	68002
Winter protection cover with elastic tensioners and DOLCEVITA 4x8 fixings	520 X 920	CODVC48	68003
Winter protection cover with elastic tensioners and DOLCEVITA 4x9 fixings	520 X 1020	CODVC49	69647
Winter protection cover with elastic tensioners and DOLCEVITA 5x10 fixings	620 X 1120	CODVC510	69648
Winter protection cover DOLCEVITA DIVA LTI 3x5	420 X 700	CODVC35DG	71251
Winter protection cover DOLCEVITA DIVA LTI 3x6	420 X 800	CODVC36DG	71252
Winter protection cover DOLCEVITA DIVA LTI 3x7	420 X 900	CODVC37DG	71249
Winter protection cover DOLCEVITA DIVA LTI 4x8	520 X 1000	CODVC48DG	71253
Winter protection cover DOLCEVITA DIVA LTI 4x9	520 X 1100	CODVC49DG	71254
Floating isothermal cover DOLCEVITA 2x4 - All models	200 X 400	COGIDV24	71450
Floating isothermal cover DOLCEVITA 2x5 - All models	200 X 500	COGIDV25	71449
Floating isothermal cover DOLCEVITA 3x5 - All models	300 X 500	COGIDV35	71451
Floating isothermal cover DOLCEVITA 3x6 - All models	300 X 600	COGIDV36	71452
Floating isothermal cover DOLCEVITA 3x7 - All models	300 X 700	COGIDV37	71453
Floating isothermal cover DOLCEVITA 4x8 - All models	400 X 800	COGIDV48	71454
Floating isothermal cover DOLCEVITA 4x9 - All models	400 X 900	COGIDV49	71455
Floating isothermal cover DOLCEVITA 5x10 - All models	500 X 1000	COGIDV510	71456

DOLCEVITA Swim system



Dolce Vita

	Description	Laghetto reference	Code
3 MT	SWIMMING KIT AGAINST THE CURRENT: 2 motors, 2 water jets, piping, electrical panel and wired remote control.	DVKITNCC020	DVKITNCC020
4 MT	SWIMMING KIT AGAINST THE CURRENT: 2 motors, 2 water jets, piping, electrical panel and wired remote control.	DVKITNCC040	DVKITNCC030
5 MT	SWIMMING KIT AGAINST THE CURRENT: 2 motors, 2 water jets, piping, electrical panel and wired remote control.	DVKITNCC050	DVKITNCC040

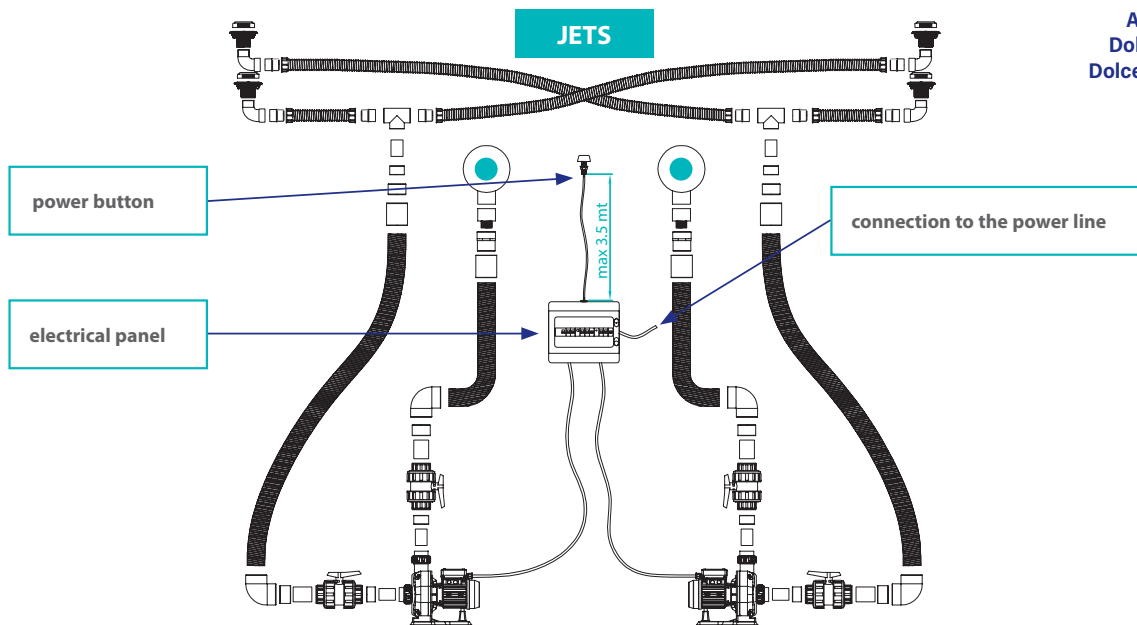

Available only on
DolceVita Naked and
DolceVita Diva LTI model.

Steel basement structure for DOLCEVITA aboveground



Dolce Vita

DolceVita above ground can be inserted in any context you like also avoiding the construction of a reinforced concrete slab using a special modular base frame made of powder-coated steel.

With this innovative and unique structural accessory, which can be accompanied by a mobility certificate and easy removal of the pool, you can install DolceVita Pool in any type of situation, satisfying your every need, even the most special.

Description	Laghetto reference	Code
STEEL BASEMENT STRUCTURE FOR A NON-SLAB ASSEMBLY DOLCEVITA 3x5	DVC35KITTB	69626
STEEL BASEMENT STRUCTURE FOR A NON-SLAB ASSEMBLY DOLCEVITA 3x6	DVC36KITTB	69627
STEEL BASEMENT STRUCTURE FOR A NON-SLAB ASSEMBLY DOLCEVITA 3x7	DVC37KITTB	69628
STEEL BASEMENT STRUCTURE FOR A NON-SLAB ASSEMBLY DOLCEVITA 4x8	DVC48KITTB	69629
STEEL BASEMENT STRUCTURE FOR A NON-SLAB ASSEMBLY DOLCEVITA 4x9	DVC49KITTB	69630
STEEL BASEMENT STRUCTURE FOR A NON-SLAB ASSEMBLY DOLCEVITA 5x10	DVC510KITTB	69631

DolceVita Divina: Not compatible with standard basement kit for direct assembly on the ground.

BASEMENT FOR DIRECT ASSEMBLY ON THE GROUND

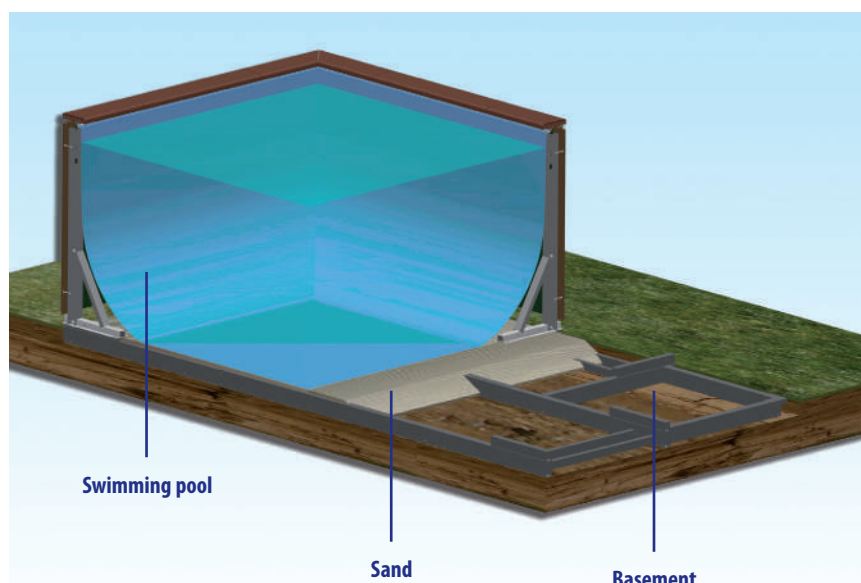

- ▶ Zero impact installation.
- ▶ For installation where no concrete basement can be made.
- ▶ Easy to move and assemble.
- ▶ Fully removable.

ABOVE GROUND POOLS - DOLCE VITA

Stainless steel components

to stabilize the structure of the pool



Dolce Vita

The kit is an AISI 304 stainless steel locking system consisting of fasteners that allow to prevent normal structural beddings (misalignment) of dolcevita during the filling phase.

Description	Laghetto reference	Code
Kit for DOLCEVITA 2x4	DV24KITAL	69616
Kit for DOLCEVITA 2x5	DV25KITAL	69617
Kit for DOLCEVITA 3x4	DV34KITAL	71123
Kit for DOLCEVITA 3x5	DV35KITAL	69619
Kit for DOLCEVITA 3x6	DV36KITAL	69618
Kit for DOLCEVITA 3x7	DV37KITAL	69620
Kit for DOLCEVITA 4x8	DV48KITAL	69621
Kit for DOLCEVITA 4x9	DV49KITAL	69622
Kit for DOLCEVITA 5x10	DV510KITAL	69623

FIXING AND ALIGMENT KIT

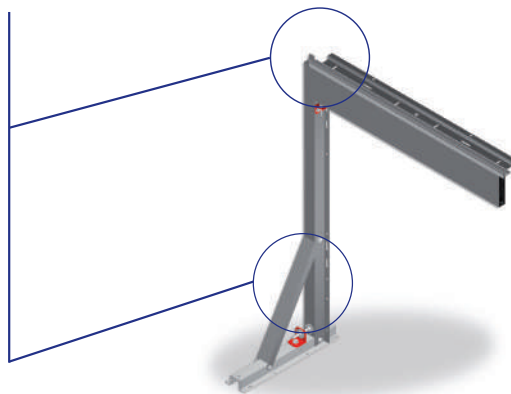

THE KIT IS AN AISI 304 STAINLESS STEEL LOCKING SYSTEM CONSISTING OF FASTENERS THAT ALLOW TO PREVENT NORMAL STRUCTURAL BEDDINGS (MISALIGNMENT) OF DOLCEVITA DURING THE FILLING PHASE.

- ▶ With the kit you can't align the pool once filled.
- ▶ It's compatible without any modification only with DolceVita structures from April 2014.
- ▶ You can't add the kit to assembled pool, to fit it you must dismantle the pool completely.
- ▶ If the DolceVita structure has been purchased before April 2014 some modifications to the structure are necessary.

Tracking template

Version	Description	Laghetto reference	Code
All	Tracking template for DolceVita Gold, DolceVita and Bluespring pool	DVMODINA	DVMODINA

DOLCEVITA: Basement sizes



Dolce Vita

CONCRETE BASE

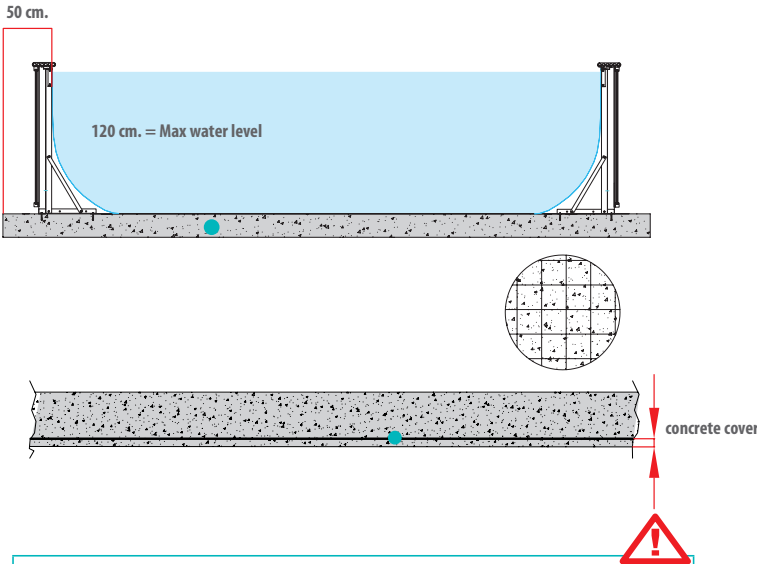

- Check with your engineer which are the optimal requirements for your installation
- Check the basement is really rectangular with the same diagonals
- The basement must support a load of 1300 Kg by square meter given from water weight
- Check the basement is achievable in case of unstable ground by geological expertise
- The basement surface must be as smoothed as plaster
- Tolerance gradient of the perimeter of slab = ± 1 cm

BASEMENT SIZES FOR DOLCEVITA DIVA AUTOMATIC COVER

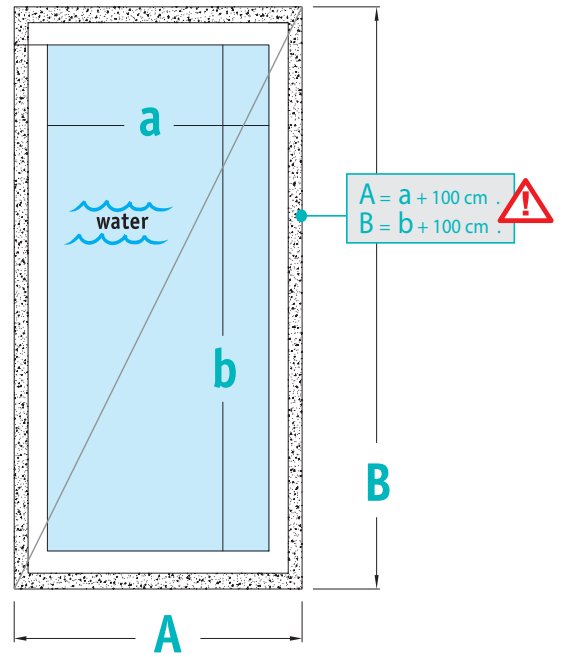

ASK FOR TECHNICAL INFORMATION TO YOUR LAGHETTO COMMERCIAL CONTACT

BASEMENT SIZES FOR DOLCEVITA DIVA LTI

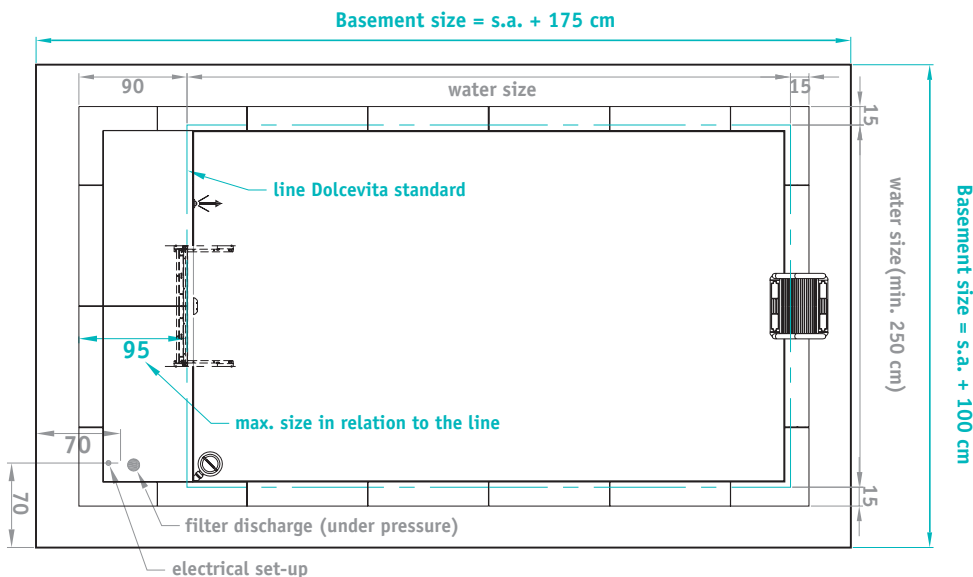

ABOVE GROUND POOLS - DOLCE VITA

DolceVita: Standard accessories position -

Skimmer, inlet and light



Dolce Vita

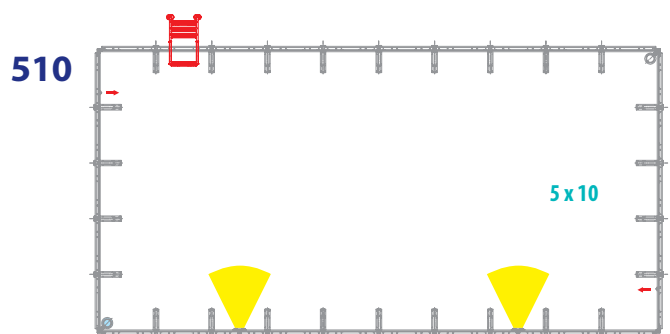
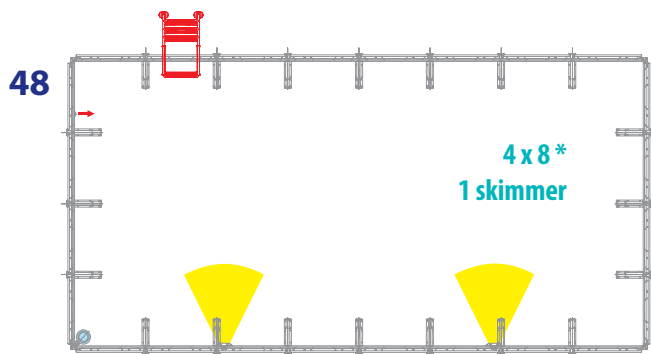
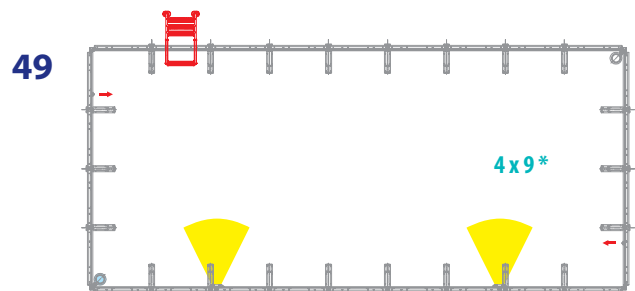
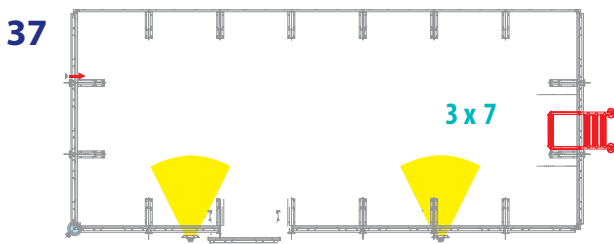
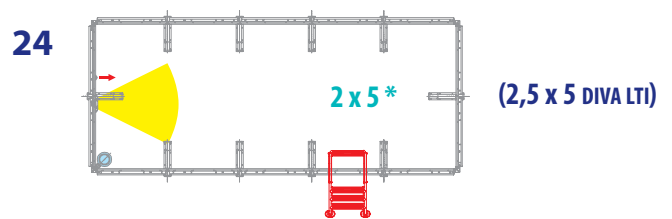
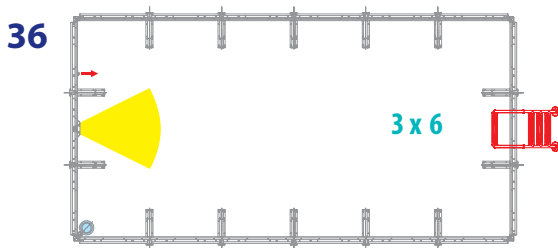
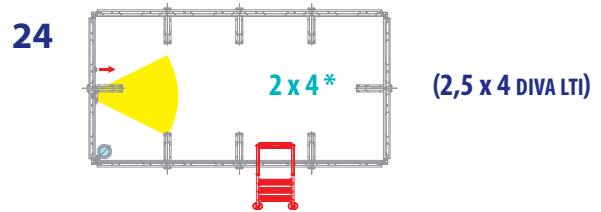
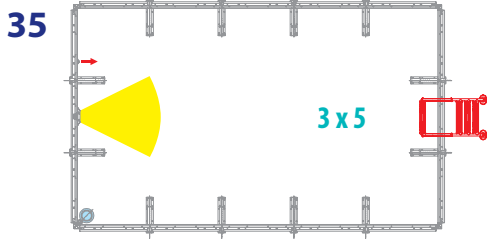

ABOVE GROUND POOLS - DIVINA

Divina

CONTEMPORARY SEMI-UNDERGROUND

Divina, the latest addition to the Laghetto Pool Design range, already expresses from its name the style and charm that distinguish it.

Its semi-underground basin is wrapped in panels with a pleasant synthetic rattan finish, hand woven on aluminium frame; embellished with a sunbed and seats with soft cushions in nautical Sky, can be equipped like a traditional swimming pool: LED spotlights, swimming against the current and heater, which allows you to enjoy the pleasure of the pool for longer.

Equipped with skimmer filtration system, with a technical room under the sunbathing area, it can be installed without impacting construction works and in just a few days.

Divina Infinity is the new concept of overflow semi-inground pool, launched in 2022, available for assembly only on concrete basement. It represents a new elegant proposal that allows to enjoy the maximum of your pool in terms of elegance, design and performances.

FEATURES

- ▶ Size: 35 - 36- 37 - 48
- ▶ Color: White.
- ▶ Filtration: Overflow + sand filter.
- ▶ RATTAN PANEL COLOR: Laghetto White - Grey
- ▶ LINER COLOR: White - Beige
- ▶ MODEL: Version only for assembly on concrete base





Divina Resort is a semi-grounded pool as Divina, but Resort has a filtration with the overflow system. The water mirror sizes are the same as Divina. Resort Model is available only in the version with structure for assembly on concrete base.

DIVINA Infinity model



1 Internal structure

2 Pool liner



5 Panels with integrated top edge.

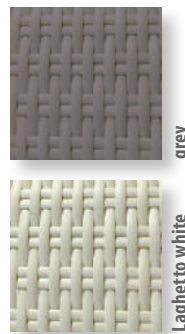

9 Ground containment panels.

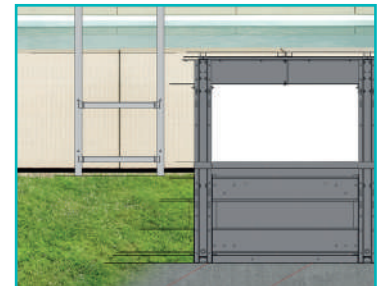

3 Filtration System (as in the diagram)
attention: the filtration system doesn't include the electrical panel.



AstralPool sand filters



6 Vacuum cleaner system.

7 FIXING AND ALIGNMENT KIT.

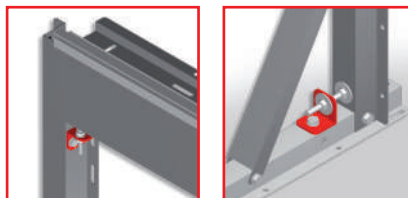

8 Luxury specific for Divina version.

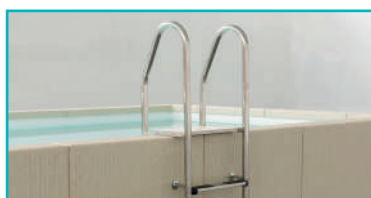

POOL KIT

$$= 1 + 2 + 3 + 4 + 5 + 6 + 7 + 8 + 9$$



PANELS AND TOP EDGE INTEGRATED IN ONE PIECE MADE OF WICKER. AVAILABLE IN TWO COLORS: GREY OR LAGHETTO WHITE. POOL LINER (COLOR CHOICE: LIGHT BLUE, SAND OR WHITE)

- x =
- BIGR** (white liner and grey panels)
 - BIBI** (white liner and white panels)
 - BEGR** (beige liner and grey panels)
 - BEBI** (beige liner and white panels)

SEMI-INGROUND POOLS - DIVINA INFINITY

DIVINA Infinity model

PISCINE
LAGHETTO®NEW
2022*Divina*

Laghetto model	Description	Laghetto reference	Code
3x5	3x5 (water mirror), white liner, Laghetto White rattan panles w. sand filter 10m ³ + 1 led light	KITDVDR35BIBIS10	-
3x5	3x5 (water mirror), white liner, Grey rattan panles w. sand filter 10m ³ + 1 led light	KITDVDR35BIGRS10	-
3x5	3x5 (water mirror), beige liner, Laghetto White rattan panles w. sand filter 10m ³ + 1 led light	KITDVDR35BEBIS10	-
3x5	3x5 (water mirror), beige liner, Grey rattan panles w. sand filter 10m ³ + 1 led light	KITDVDR35BEGRS10	-
3x6	3x6 (water mirror), white liner, Laghetto White rattan panles w. sand filter 10m ³ + 1 led light	KITDVDR36BIBIS10	-
3x6	3x6 (water mirror), white liner, Grey rattan panles w. sand filter 10m ³ + 1 led light	KITDVDR36BIGRS10	-
3x6	3x6 (water mirror), beige liner, Laghetto White rattan panles w. sand filter 10m ³ + 1 led light	KITDVDR36BEBIS10	-
3x6	3x6 (water mirror), beige liner, Grey rattan panles w. sand filter 10m ³ + 1 led light	KITDVDR36BEGRS10	-
3x7	3x7 (water mirror), white liner, Laghetto White rattan panles w. sand filter 15m ³ + 2 led light	KITDVDR37BIBIS15	-
3x7	3x7 (water mirror), white liner, Grey rattan panles w. sand filter 15m ³ + 2 led light	KITDVDR37BIGRS15	-
3x7	3x7 (water mirror), beige liner, Laghetto White rattan panles w. sand filter 15m ³ + 2 led light	KITDVDR37BEBIS15	-
3x7	3x7 (water mirror), beige liner, Grey rattan panles w. sand filter 15m ³ + 2 led light	KITDVDR37BEGRS15	-

DIVINA model

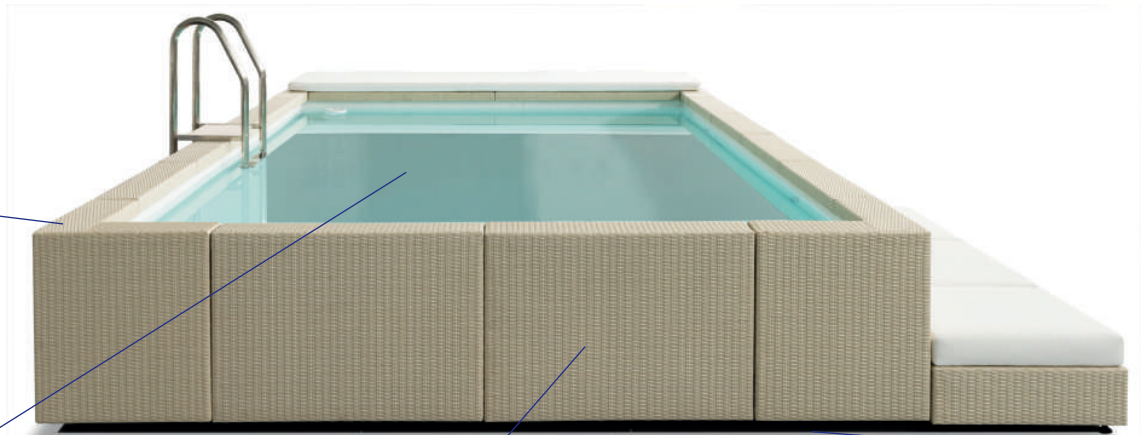

1
Internal structure

2
Pool liner

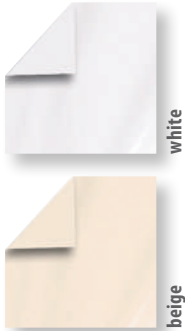

5
Panels with integrated top edge.

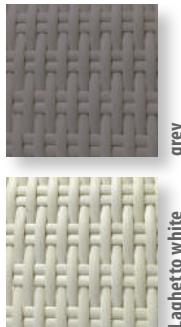

9
Ground containment panels.

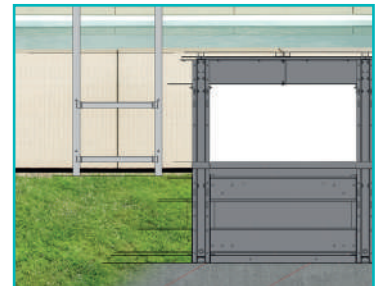

3
Filtration System (as in the diagram)
attention: the filtration system doesn't include
the electrical panel.



AstralPool sand filters

6
Vacuum cleaner system.

7
FIXING AND ALIGNMENT KIT.

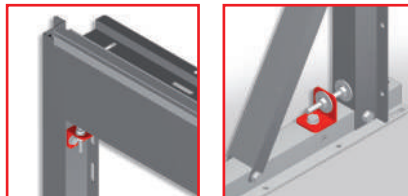

4
High brightness LED spotlight:
1 Spot until model 36,
2 Spots from model 37

8
Luxury specific for Divina version.

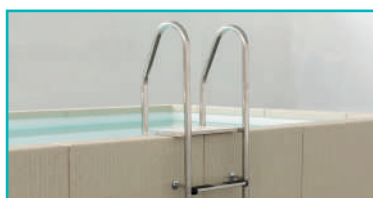

POOL KIT

$$= 1 + 2 + 3 + 4 + 5 + 6 + 7 + 8 + 9$$



PANELS AND TOP EDGE INTEGRATED IN ONE
PIECE MADE OF WICKER. AVAILABLE IN TWO
COLORS: GREY OR LAGHETTO WHITE.
POOL LINER (COLOR CHOICE: LIGHT BLUE,
SAND OR WHITE)

x =

- BIGR** (white liner and grey panels)
- BIBI** (white liner and white panels)
- BEGR** (beige liner and grey panels)
- BEBI** (beige liner and white panels)

SEMI-INGROUND POOLS - DIVINA

DIVINA model

structure ONLY for assembly on CONCRETE BASE

Divina



Laghetto model	Description	a) Laghetto reference	Code
3x5	1 skimmer 10 m ³ h sand filtering system	KITDVC35XS10DSCA	-
3x6	1 skimmer 10 m ³ h sand filtering system	KITDVC36XS10DSCA	-
3x7	1 skimmer 10 m ³ h sand filtering system	KITDVC37XS10DSCA	-
4x8	1 skimmer 10 m ³ h sand filtering system	KITDVC48XS10DSCA	-

Steel basement structure

structure ONLY for assembly on GROUND

Divina



Dolcevita Divina can be inserted in any context you like also avoiding the construction of a reinforced concrete slab using a special modular base frame made of powder-coated steel.

Laghetto model	Description	b) Laghetto reference	c) Steel basement structure*	Code
3x5	1 skimmer 10 m ³ h sand filtering system	KITDVC35XS10DSTB	DVC35KITTB	-
3x6	1 skimmer 10 m ³ h sand filtering system	KITDVC36XS10DSTB	DVC36KITTB	-
3x7	1 skimmer 10 m ³ h sand filtering system	KITDVC37XS10DSTB	DVC37KITTB	-
4x8	1 skimmer 10 m ³ h sand filtering system	KITDVC48XS10DSTB	DVC48KITTB	-

*Please remember to indicate also the steel basement structure code in the purchase order.

Substitute **X** for the following 4 letters, according to the desired color combination:

BIGR white liner and grey panels

BEGR beige liner and grey panels

BIBI white liner and white panels

BEBI beige liner and white panels

POP!

is the range of above ground pools with which Laghetto celebrate its first 40 years in the swimming pool industry.

It's the result of four decades of patents and innovative projects and represent the highest expression of quality on the above ground pools market.

The Pop range is available both in 100 and 120 cm water depth in a wide choice of soft, cool and fashion colors you can set in a pleasant and unconventional way in your space or garden.

STANDARD EQUIPMENT

- ▶ LED lights.
- ▶ Safety ladder.
- ▶ Exclusive Laghetto water filtration and treatment system. Choice of AstralPool sand filters.
- ▶ Special foot blocks for ground assembly.

POP!



POOL WARRANTY: 5 YEARS
ACCESSORIES WARRANTY: 2 YEARS

POP!

Pool liner



Patented Laghetto skimmer



Above-ground pool foot support



LINER

Made of PVC coated polyester fabric membrane is incredibly strong (it easily pass DIN 53354 test up to traction of 430 Kg on 5 cm) , it is treated with a special coating that prevents dirt from attaching to exposed areas and provides protection against damage caused by UV light to be very durable. Every Laghetto POP liner is available in 6 cool colors and comes with the distinctive red label.

LAGHETTO SKIMMER

The legendary skimmer of Piscine Laghetto is directly attached to the corner of the pool liner. The floating head skims the water surface with a perfectly efficient 360 degree action. This is the most effective skimmer design on the market. Every skimmer includes a pre-filter basket (if used with sand or cartridge filtration systems) or a special microfiber fabric filtrating element (Boa system). The wide excursion of the floating head follows the water level precisely for a better efficiency and avoids almost completely unwanted air draw that can damage the pump of the filtration system. Every skimmer head is equipped with devices for the safety of all swimmers.

FOOT BLOCKS

Every pool is supplied with a complete set of foot blocks that replace the need for any support under the pool legs by providing a solid base. Foot blocks come in white color to match the structure and the top of the Liners.



Laghetto pipes



Safety ladder



Vacuum cleaner



PIPINGS

The pipes of the filtration systems are another of the high quality components that characterize Piscine Laghetto products. Pipes for POP pools are made of highly resistant and durable white corrugated PVC, with one - and - a half inch fittings, pressure mounted and glued together (factory assembled to ensure the best possible seal over time). The pipes, with threaded connectors and gaskets, are screwed to the wall fittings of the pool and to nipples of the filtering system, without using any type of cable tie.

LAGHETTO SAFETY LADDER

Introduced already back in year 2000, Piscine Laghetto safety ladder is the most stable and secure aboveground pool ladder on the market. It's connected directly to the pool structure to avoid overturning and the outside steps can be lifted to avoid the entrance of the kids when the pool is unattended or unused.

VACUUM CLEANER

Every POP Pool kit also include a vacuum cleaner (pipe length varies according to the pool size and the number of skimmers).



AstralPool sand filters



SAND FILTRATION SYSTEMS

The technical partnership between Piscine Laghetto and AstralPool introduces the 6, 10 and 15 mc/h sand filters in all swimming pool kits.



ABOVE GROUND POOLS - POP

POP! model: Colors choice

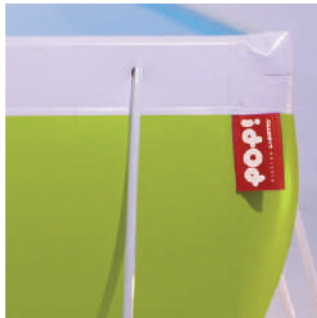

... ML
CATERPILLAR GREEN



... LV
BUTTERFLY LILAC

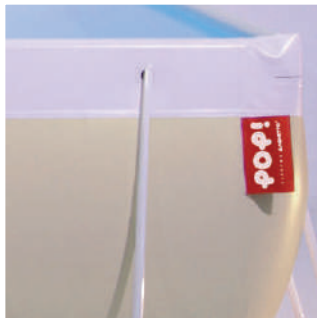

... CR
SEA SAND



... BL
LAGHETTO BLUE



The range of Laghetto Pop pools is available in 4 colors: Caterpillar Green, Butterfly Lilac, Sea Sand and Laghetto Blue.

POP!	WATER SIZE (m)	AVAILABLE COLOURS	ENCUMBRANCE WITH FOOT SUPPORTS (m)	ENCUMBRANCE WITHOUT FOOT SUPPORTS (m)	VOLUME (m ³)
24	2,80 x 4,00 x h.1,2		3,84 x 5,04	3,60 x 4,80	13,5
25	2,80 x 5,30 x h.1,2		3,84 x 6,34	3,60 x 6,10	17
26	2,80 x 6,60 x h.1,2		3,84 x 7,64	3,60 x 7,40	21,5
27	2,80 x 7,80 x h.1,2		3,84 x 8,84	3,60 x 8,60	25
46	4,00 x 6,60 x h.1,2		5,04 x 7,64	4,80 x 7,40	30,5
47	4,00 x 7,80 x h.1,2		5,04 x 8,84	4,80 x 8,60	36
49	4,00 x 9,00 x h.1,2		5,04 x 10,04	4,80 x 9,80	41,5
510	5,30 x 10,25 x h.1,2		6,34 x 11,29	6,10 x 11,05	62,5
511	5,30 x 11,50 x h.1,2		6,34 x 12,54	6,10 x 12,30	70
612	6,60 x 12,70 x h.1,2		7,64 x 13,74	7,40 x 13,50	96,5



POP Crystal

POP!

Something thrilling for the 2022 summer? A new above ground pool that will fascinate everyone with its strips of transparent liner that create a suggestive light effect both during the day and the night, when it creates a magical and inimitable atmosphere.

Available in two sizes and two liner colors, it is equipped with a sand filtration system (6 m³/h) and all the same equipment as POP pools, with led lights to create and emphasize the magic of light beams through the crystal transparent liner stripes.



FEATURES

- ▶ Size: 24 (2X4M) - 25 (2X5M).
- ▶ Color: White.
- ▶ Filtration: Sand - 6 m³/h.

Description	Laghetto reference	Code
SIZE 24 - WHITE	KITCRYS24BIS6	-
SIZE 25 - WHITE	KITCRYS25BIS6	-
SIZE 24 - BEIGE	KITCRYS24BES6	-
SIZE 25 - BEIGE	KITCRYS25BES6	-





POP! model



POP!

- Pool kits with 1 / 2 skimmers, sand filter, manual pool cleaner, ladder, 1 / 2 small LED spotlights and support footblocks.

Laghetto model	Description	Total dimensions (W x L x H) cm	Water dimensions (W x L x H) cm	Water volume Litres	Packaging dimensions	Total gross weight Kg	Laghetto reference	Color	Code
POP 120 - 24	Pool kit filter 6 m ³ / h 1 skimmer 1 spotlight LED	384x504	280x400x120	13500	110 x 140 x 125	184	KITPOP24MLS6	caterpillar green	69366
							KITPOP24CRS6	sea sand	69369
							KITPOP24LVS6	butterfly lilac	69376
							KITPOP24BLS6	laghetto blue	-
POP 120 - 25	Pool kit filter 6 m ³ / h 1 skimmer 1 spotlight LED	384x634	280x530x120	17000	110 x 140 x 130	205	KITPOP25MLS6	caterpillar green	69365
							KITPOP25CRS6	sea sand	69370
							KITPOP25LVS6	butterfly lilac	69379
							KITPOP25BLS6	laghetto blue	-
POP 120 - 26	Pool kit filter 6 m ³ / h 1 skimmer 1 spotlight LED	384x764	280x660x120	21500	110 x 140 x 160	224	KITPOP26MLS6	caterpillar green	-
							KITPOP26CRS6	sea sand	69371
							KITPOP26LVS6	butterfly lilac	69378
							KITPOP26BLS6	laghetto blue	-
POP 120 - 27	Pool kit filter 10 m ³ / h 1 skimmer - 1 spotlight LED	384x884	280x780x120	26200	100 x 140 x 160	258	KITPOP27MLS	caterpillar green	70481
							KITPOP27CRS	sea sand	70857
							KITPOP27LVS	butterfly lilac	-
							KITPOP27BLS	laghetto blue	-
POP 120 - 46	Pool kit filter 10 m ³ / h 1 skimmer - 1 spotlight LED	504x764	400x660x120	30500	110 x 140 x 160	262	KITPOP46MLS	caterpillar green	69367
							KITPOP46CRS	sea sand	-
							KITPOP46LVS	butterfly lilac	-
							KITPOP46BLS	laghetto blue	-
POP 120 - 47	Pool kit filter 10 m ³ / h 1 skimmer - 1 spotlight LED	504x884	400x780x120	36000	110 x 140 x 170	287	KITPOP47MLS	caterpillar green	69368
							KITPOP47CRS	sea sand	69373
							KITPOP47LVS	butterfly lilac	-
							KITPOP47BLS	laghetto blue	72842
POP 120 - 49	Pool kit filter 15 m ³ / h 2 skimmers - 1 spotlight LED	504x1004	400x900x120	43200	100 x 140 x 180	335	KITPOP49BLGS	laghetto blue	-
POP 120 - 510	Pool kit filter 15 m ³ / h 2 skimmers - 1 spotlight LED	634x1129	530x1025x120	-	-	-	KITPOP510BLGS	laghetto blue	-
POP 120 - 511	Pool kit filter 15 m ³ / h 2 skimmers - 1 spotlight LED	634x1254	530x1150x120	-	-	-	KITPOP511BLGS	laghetto blue	-
POP 120 - 612	Pool kit filter 15 m ³ / h 2 skimmers - 1 spotlight LED	764x1374	660x1270x120	-	-	-	KITPOP612BLGS	laghetto blue	-

POP! accessories - Covers

POP!



POOL COVER



SUN COVER

Description	Code
Isothermal bubble cover POP24	LACS24
Winter cover grey POP24	LACH24G
Winter cover beige POP24	LACH24BE
Winter cover blue POP24	LACH24BL
Isothermal bubble cover POP25	LACS25
Winter cover grey POP25	LACH25G
Winter cover beige POP25	LACH25BE
Winter cover blue POP25	LACH25BL
Isothermal bubble cover POP26	LACS26
Winter cover grey POP26	LACH26G
Winter cover beige POP26	LACH26BE
Winter cover blue POP26	LACH26BL
Isothermal bubble cover POP27	LACS27
Winter cover grey POP27	LACH27G
Winter cover beige POP27	LACH27BE
Winter cover blue POP27	LACH27BL
Isothermal bubble cover POP46	LACS46
Winter cover grey POP46	LACH46G
Winter cover beige POP46	LACH46BE
Winter cover blue POP46	LACH46BL

Description	Code
Isothermal bubble cover POP47	LACS47
Winter cover grey POP47	LACH47G
Winter cover beige POP47	LACH47BE
Winter cover blue POP47	LACH47BL
Isothermal bubble cover POP49	LACS49
Winter cover grey POP49	LACH49G
Winter cover beige POP49	LACH49BE
Winter cover blue POP49	LACH49BL
Isothermal bubble cover POP510	LACS510
Winter cover grey POP510	LACH510G
Winter cover beige POP510	LACH510BE
Winter cover blue POP510	LACH510BL
Isothermal bubble cover POP511	LACS511
Winter cover grey POP511	LACH511G
Winter cover beige POP511	LACH511BE
Winter cover blue POP511	LACH511BL
Isothermal bubble cover POP612	LACS612
Winter cover grey POP612	LACH612G
Winter cover beige POP612	LACH612BE
Winter cover blue POP612	LACH612BL

POP! model: Standard accessories position -

Skimmer, inlet and light



POP!

24

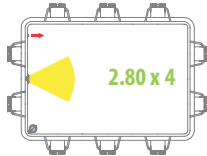

47

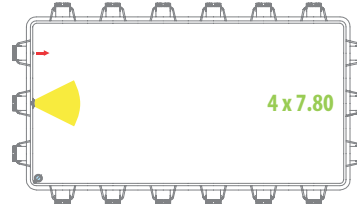

25

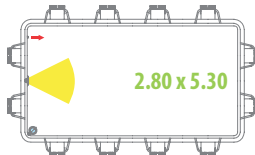

49

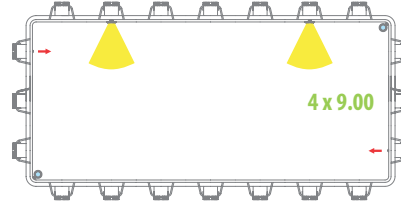

26



511



27



510



46

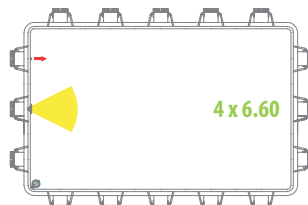

612

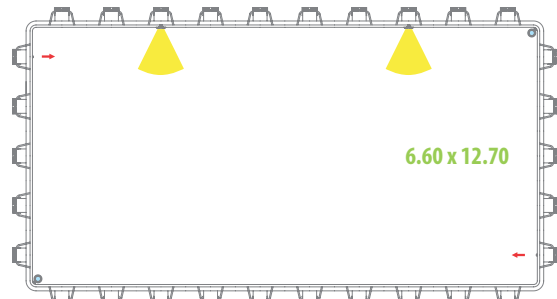



your water mirror



Dolce Vita

Elegant in design, this system has revolutionized the world of pools. The unbeatable quality rattan and sound technology ensure a long service life.



PLAYA

An extremely elegant mini-pool that is perfectly suited for terraces and gardens.

Hot water, an air massage and bubble feature, and a space for sunbathing.

Available in Laghetto's colours: white, grey and coffee.



POP!

The classic above-ground pool has been revamped to bring colour into your garden.

Pop! can be white, sand, green or lilac. Design adapted to new technology backed by 40 years of experience.

For further information go to: www.piscinelaghetto.com

Classic



THE CLASSIC LAGHETTO

Classic is the line of above ground pools that for decades has represented the history of the above ground pool and of the Piscine Laghetto brand, thanks to the unrivalled mix of quality, durability and reliability.

Classic is continuity in the Piscine Laghetto tradition, made up of made in Italy swimming pools, the result of unceasing evolution and over 40 years of research, experience and innovation that allow those pools to be used in the widest variety of contexts and conditions.



TECHNICAL FEATURES

High impermeability PVC coated high strength pool membrane

Patented Laghetto skimmer with 360 degrees performance

Heavy duty PVC pipes and fitting

Safety ladder

Exclusive Laghetto filtration systems

Foot blocks for assembly on unpaved surfaces

Vacuum cleaner

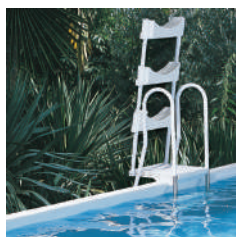

Classic Professional

The technology of Laghetto **Professional Classic** is also the base for the production of large pools that are used worldwide by event organizers that need a pool ready in a few hours, extraordinarily strong, suitable to resist the many different situations. The design capacity of our research and development team is able to satisfy every request from the customer. Classic Professional is available in customisable sizes from 7.5 x 15 m.

ABOVE GROUND POOLS - CLASSIC

CLASSIC model*Classic*

Laghetto model	Water size	Water height	Total encumbrance*	Volume (mc)	Laghetto reference	Code
24	2.80 x 4.00	1.2	3.84 x 5.04	13.5		
25	2.80 x 5.30	1.2	3.84 x 6.34	17		
26	2.80 x 6.60	1.2	3.84 x 7.64	21.5		
27	2.80 x 7.80	1.2	3.84 x 8.84	25		
47	4.00 x 7.80	1.2	5.04 x 8.84	36		

* Overall dimensions of the pool including foot blocks.



- + Pool manufactured in one piece in satin-finish, AISI-316L stainless steel.
- + With a 2 mm thickness wall and with skimmers. It includes a non-slip bottom.

- Hydraulic pre-installation included.
- Ready to connect.
- Easy installation, without building work.
- Total security and quality.

+ 2 Different models:

OPTIMAL

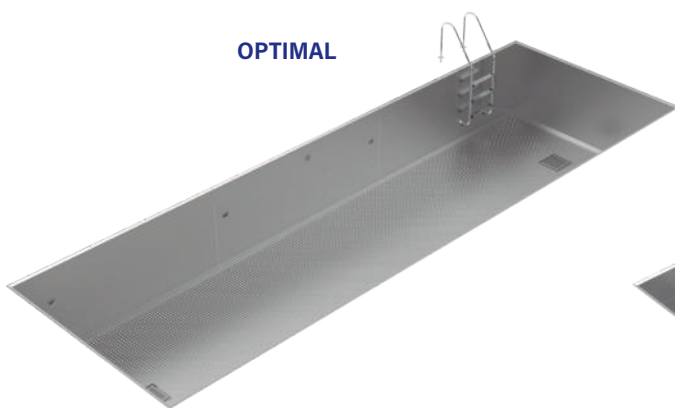

Optimal model is a residential pool made in one piece in satin-finish stainless steel, AISI-316L including skimmers. It includes a ladder.

WELLNESS

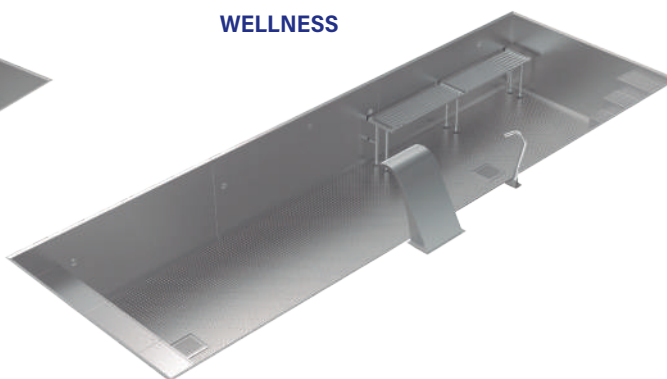

Wellness model is a residential pool made in one piece in satin-finish stainless steel, AISI-316L including skimmers.

Including:

- Steps
- Hydromassage bench
- Hydromassage cascade
- Hydromassage water jet
- Cover



INOXPOOL

Model comparison

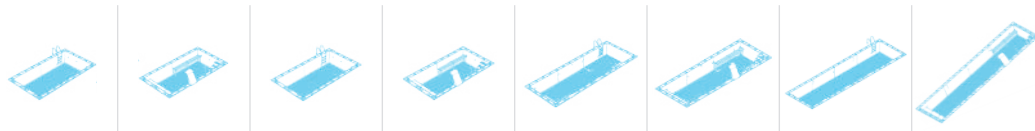
ASTRALPOOL 

	5 x 3 x 1.2 m		7 x 3 x 1.2 m		9 x 3 x 1.2 m		12 x 3 x 1.2 m	
MODELS	Optimal	Wellness	Optimal	Wellness	Optimal	Wellness	Optimal	Wellness
Code	71499	71500	71504	71505	71511	71512	71518	71519

General specifications

Internal dimensions (m)	5 x 2.85 x 1.2		7 x 2.85 x 1.2		8.84 x 2.85 x 1.2		11.84 x 2.85 x 1.2	
External dimensions (m)	5.7 x 3.6 x 1.3		7.7 x 3.6 x 1.3		9.6 x 3.6 x 1.3		12.6 x 3.6 x 1.3	
Water capacity (m ³)	18		24		31		41	
Empty weight / Full weight (kg)	2100 / 20100	2300 / 20300	2650 / 26650	2850 / 26850	3250 / 34250	3350 / 34350	4050 / 45050	4200 / 45200

Characteristics

Skimmers	2	2	2	2	3	3	4	4
Overflow suction	-	-	-	-	-	-	-	-
Return inlet	3	4	3	4	4	5	5	6
Bottom cleaner nozzle	1	1	1	1	1	1	2	2
Main drains	2	2	2	2	2	2	2	2
Projectors	2	2	2	2	2	2	3	3

Accessories

Ladder (3 steps)	•	-	•	-	•	-	•	-
Steps	-	•	-	•	-	•	-	•
Hydromassage bench	-	•	-	•	-	•	-	•
Hydromassage cascade	-	•	-	•	-	•	-	•
Hydromassage water jet	-	•	-	•	-	•	-	•
Hydromassage beds	-	-	-	-	-	-	-	-
Countercurrent	-	-	-	-	-	-	-	-
Cover	-	•	-	•	-	•	-	•

Recommended equipment

Hydraulic button and timer	-	45218 + 35761	-	45218 + 35761	-	45218 + 35761	-	45218 + 35761
Blower pump for hydro beds	-	-	-	-	-	-	-	-
Blower pump for hydro bank	-	35388	-	35388	-	35388	-	35388



SPAS AND SAUNAS



482	Our range of spas	497	In-ground residential spas
483	Colour chart for spas	499	Compact filtration for spas
483	Coding structure for private spas with cabinet	500	Complements for spas
483	Types of coatings	502	Liner accessories
484	Optional equipment	506	Pool Jet accessories
485	Standard equipment	507	Accessories for minispas
490	Spa range - Ocean Dreams range	510	Electrical accessories for spas / mini spas
493	Spa range - Essential range	511	Air blowers
495	Spa range - Swimsa range	514	Saunas
		520	Accessories - Saunas

Our range of spas



Ocean Dreams range

- + A range of spas intended for the most demanding users.
- + Ergonomic spas, with numerous features and configuration settings.



Swimspa range

- + Swimspas are small residential pools.
- + Versatile, powerful and compact. A health and wellness centre available all year round.



Essential range

- + The Essential range seeks to strike a balance between functionality, performance and cost.



Commercial range

- + Spas designed for commercial spaces, wellness centres, hotels...
- + A wide range of options and finishes that cover all needs. Spas with both an acrylic and mosaic tile finish.

Colour chart for spas



Coding structure for private spas with cabinet

The coding structure for the wood cabinet spas is made up of 10 digits. The first 5 digits refer to the Spa model and the following ones indicate the range, coating and the colour of the accessories as it is also necessary to specify the colour.

This coding system will be structured in the following way:

XXXXX	X	X	X	XX	CL	XX
Spa Model	Range	Coating type	Accessory colour	Accessories	Variation	Colour

Position 1 to 5: Standard code 5 figure code

Position 6: Product range definition

S	Standard
A	Plus

Position 7: Coating type definition

1	Coastal Grey portable spa with cabinet
4	Portable spa without cabinet
E	In-ground spa, compact kit version
B	Urban Grey cabinet
K	Graphite cabinet
P	Graphite cabinet with screw
R	Thunder cabinet
Q	Thunder cabinet with screw
T	Creek cabinet
C	Infinity cabinet
S	Solid Surface
W	Butterfly cabinet

Position 8: Accessories colour definition

3	Stainless steel
---	-----------------

Positions 9 to 10: Options configuration definition

00	Std + Cover
05	Std + Cover + ECOspa
20	Std + Cover + LumiPlus
21	Std + Cover + ECOspa + LumiPlus
23	Std + Cover + LumiPlus + Audio
32	Std + Cover + LumiPlus + Stainless steel bar on cabinet
27	Std + Cover + LumiPlus + ECOspa + Stainless steel bar on cabinet
33	Std + Cover + LumiPlus + Audio + Stainless steel bar on cabinet
34	Std + Cover + LumiPlus + ECOspa + Audio
35	Std + Cover + LumiPlus + ECOspa + Audio + Stainless steel bar on cabinet
56	Std + Cover + LumiPlus + EcoSpa + Audio + Stainless Steel Bar on Cabinet + Wi-Fi Touch Panel
55	Std + Cover + LumiPlus + EcoSpa + Nordic Insulation + Audio + Stainless Steel Bar on Cabinet + Wi-Fi Touch Panel
0J	Std + Cover + LumiPlus + EcoSpa + Stainless Steel Bar on Cabinet + Blue Connect Plus

Types of coatings

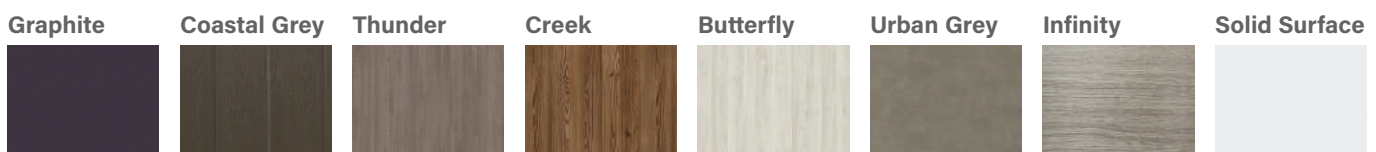

OPTIONAL EQUIPMENT

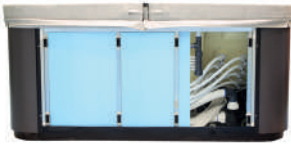

EcoSpa thermal insulation

EcoSpa is one of the best thermal insulation systems currently available in the market. This comprehensive system manages to minimize heat loss by convection and conduction, and to use the heat generated by the heater and pumps found in the spa. The walls have an exclusive 30 mm thick layer of polyurethane foam insulation. A strong ABS substructure of insulating plastic at the bottom of the spa ensures total water tightness. Finally, an isothermal cover of between 100 and 130 cm thick gives extra insulation.

All of these features reduce heat loss to a minimum and maximize the recovery of the heat generated by the spa's components, thus reducing energy consumption by up to 67%. With ECOSpa, consumption to maintain the water at 38° with a room temperature of 20° is 6.48 kW/h, while without this system it is 19.52 kW/h.

EcoSpa option

NORDIC
INSULATION
SYSTEM

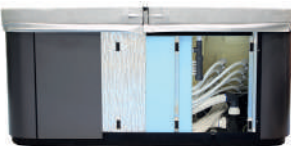

Nordic Insulation System

NORDIC INSULATION SYSTEM is designed for cold environments and can enhance your spa's energy efficiency.

The Nordic insulation system comprises a 10mm insulating material composed of five layers. This insulation layer is positioned in the sides and curves of the spa to create an insulating air chamber inside. The five layers are made from:

- Aluminium.
- RC9 bubble + low-density polyethylene (double layer).
- FONPEX non-crosslinked polyethylene foam (20 kg/m³).
- RC9 bubble + low-density polyethylene (double layer).
- Aluminium.

This system is an improvement over the EcoSpa class as it minimizes temperature leak zones and optimizes spa energy performance in extreme temperature situations.

Difference between the EcoSpa and Nordic insulation systems in thermal imaging:

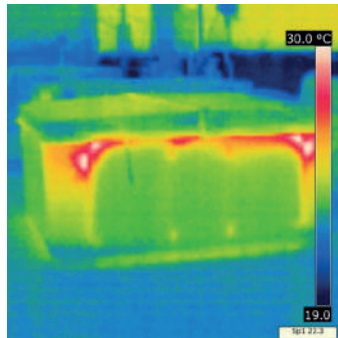

Spa with EcoSpa

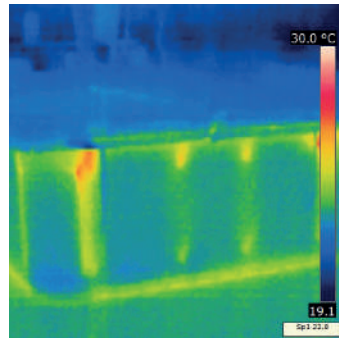

Spa with Nordic insulation system

Wi-Fi Touch panel

The Balboa Wi-Fi control panel is an app for your smart device (Android™ or iPhone®) which lets you access your spa over the internet from anywhere, home or away. All you need is a 3G, 4G or Wi-Fi connection to access and control your spa over your mobile phone or tablet.

By using the Wi-Fi control panel, you can make sure that your spa is ready for use every time you want to take a dip. Instead of having to go outside and fiddle around with the buttons on the control panel, this app will enable you to change your spa's settings from your mobile phone or tablet.

The app has a full control interface so you can set the water temperature, run the massage pumps and even control the filtration cycle.

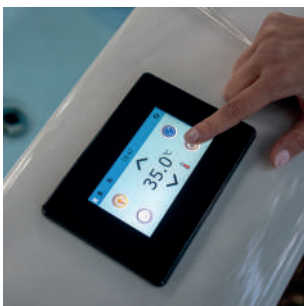

OPTIONAL EQUIPMENT

LumiPlus + Bluetooth Audio System, only available for fully skirted portable spas

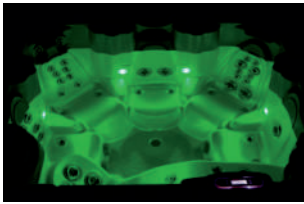
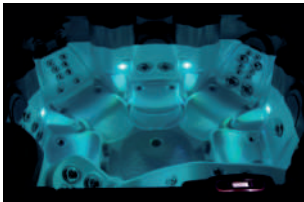

Natural treatments are one of the main sources of health provided by a spa. Chromotherapy and music therapy are the perfect accompaniment to any hot tub.

Chromotherapy is the natural technique based on the use of colours to help your mind and body find their natural physical, mental and emotional balance. By choosing the LumiPlus option, 5 LED spotlights are added to your spa so that you can enjoy a spectacular ambient lighting system. Thanks to the 5 LED spotlights, you can choose the colours that match your mood at any given time.



The Bluetooth Audio System enables music to be played from any mobile phone, MP4 Player or audio equipment via a simple Bluetooth connection, without the need for any cables and with coverage of up to 7 metres. Now you can truly make your spa a centre of relaxation, health and beauty.

The Advance range has a 4.1 Bluetooth Audio system made up of 4 external loudspeakers, an internal subwoofer and a Bluetooth receiver.

The Essential range has a 2.1 Bluetooth Audio system made up of 2 external loudspeakers, an internal subwoofer and a Bluetooth receiver.

LumiPlus + Bluetooth Audio System option

Blue Connect Plus



Enjoy your Hot Tub with peace of mind

Blue Connect analyzes the quality of the water and shows you the needed chemicals for the maintenance of your Hot Tub.

Advanced technology connected to your smartphone

Blue Connect Plus is a smart hot tub water analyser that controls the quality of your water and informs you about the number of products available for your hot tub. All from your smartphone.

Sit back and relax. Thanks to Blue Connect, your Hot Tub is at your fingertips

Monitor your Hot Tub wherever you are with the connected Hot Tub water analyzer and the free Blue Connect app.

STANDARD EQUIPMENT

Balboa Electronics, standard in all spas



AstralPool only uses new generation control systems made by BALBOA, a leading supplier of electronic controls for hydromassage tubs and spas.

With the continual improvement made to its designs and its innovative solutions to increase the quality and reliability of its systems, the Balboa EL/GL and VS/GS family of control systems has been designed using patented M7 technology for temperature and flow sensors, and its new universal control system increases the flexibility of its functions and reduces installation and configuration problems.

These characteristics make the controls even more reliable, easier to install and easier to use.



Ozone disinfection system

Ozone is "active oxygen", a special element found in nature. Ozone is a powerful oxidising agent and, unlike traditional chemical products, it does not leave toxic waste behind, and when it has done its work it simply turns back into oxygen. Moreover, tests have proved that it effectively kills bacteria and mould.

AstralPool manufactures spas that give high quality performance and supplies an integrated ozone generator as a standard feature in all of its portable spas. The ozonator has numerous benefits: the water in spas will be safer, cleaner, purer, free of chloramines, trihalomethane and other chlorine by-products, with a high redox potential. Greater water clarity and algae control are obtained using lower concentrations of chemical substances.

A spa with water purified with ozone is one of the most pleasant relaxation and hydrotherapy experiences.

Ultraviolet disinfection system

Spas equipped with the ultraviolet system are disinfected using UV technology. Thanks to a UV lamp, all bacteria in the water are destroyed. The advantages of the ultraviolet system can be summarized as follows:

- It ensures water remains fresh, clean and clear.
- It is an efficient and safe way of disinfecting the water.
- Its UV-C light breaks down combined chlorine.
- It protects the water from germs.
- It keeps the formation of mould, bacteria and algae under control.
- It can reduce the amount of chlorine and other chemical products used by up to 80%.
- It prevents the smell of chlorine and irritation to the skin and eyes (bloodshot eyes).
- It is more environmentally friendly than traditional methods.

Using this system, all bacteria, mould and algae will automatically be removed from your spa, and it will be protected from germs without the need for any kind of maintenance.

Aroma, only available for spas with a blower



Aromatherapy offers the therapeutic properties of pure aromas for a natural treatment and makes a significant contribution in helping to restore your natural state of balance and harmony.

Nobody is indifferent to smells. They bring to mind emotions, memories and ideas. Increase the relaxing effect of your tub by adding a fragrance!



Model comparison



MODELS	Ocean Dreams range						Essential range			
	Pure	New'Art	Evolution	Atlantida 70	Pacific 70	Ocean 70	Select E	Emotion E	Equilibre E	Balance E
Code	68450	68449	32474	62399	69130	69863	76894	69122	73076	74134
General Information										
Size cm (± 2 cm)	220 x 220 x 78	220 x 220 x 78	233 x 233 x 91	216 x 216 x 90	216 x 216 x 90	216 x 167 x 74	216 x 216 x 90	216 x 216 x 90	216 x 148 x 90	198 x 198 x 74
Places (Seats/Loungers)	4 (4 / -)	5 (3 / 2)	5 (3 / 2)	5 (3 / 2)	6 (5 / 1)	3 (1 / 2)	6 (5 / 1)	5 (3 / 2)	3 (2 / 1)	5 (3 / 2)
Graphite Cabinet	-	-	•	•	•	•	•	•	-	-
Coastal Grey cabinet	-	-	-	-	-	-	-	-	-	-
Thunder Cabin	-	-	Optional	Optional	Optional	Optional	Optional	Optional	-	-
Creek Cabinet	-	-	Optional	Optional	Optional	Optional	-	-	-	-
Butterfly Cabinet	-	-	Optional	Optional	Optional	Optional	-	-	-	-
Infinity Cabinet	-	-	-	-	-	-	-	-	•	•
Solid surface Cabinet	•	•	-	-	-	-	-	-	-	-
Without cabinet	-	-	Optional	Optional	Optional	Optional	Optional	Optional	Optional	Optional
Options										
EcoSpa thermal insulation	•	•	Optional	Optional	Optional	Optional	Optional	Optional	Optional	Optional
Nordic Insulation	Optional	Optional	Optional	Optional	Optional	Optional	-	-	-	-
Bluetooth Audio system	Optional (Sist. 4.1)	Optional (Sist. 4.1)	Optional (Sist. 4.1)	Optional (Sist. 4.1)	Optional (Sist. 4.1)	Optional (Sist. 4.1)	Optional (Sist. 2.1)	Optional (Sist. 2.1)	-	Optional (Sist. 2.1)
LumiPlus LED lighting system	•	•	•	•	•	•	Optional	Optional	-	-
Stainless steel jets	•	•	•	•	•	•	•	•	•	•
Stainless steel bar	-	-	•	•	•	•	-	-	-	-
Wi-Fi Touch Panel	Optional	Optional	Optional	Optional	Optional	Optional	-	-	-	-
Blue Connect Plus	-	-	Optional	Optional	Optional	Optional	-	-	-	-
Configurations										
No of jets	27	28	56	52	51	42	51	32	26	31
No. of blower nozzles	12	14	16	14	10	-	-	12	-	12
Waterfalls	-	-	-	2	2	-	1	-	-	-
Water Fountain	-	-	2	-	-	-	-	-	-	-
Headrests	2	3	3	3	3	3	3	3	3	3
Digital control panel	1	1	2	1	1	1	1	1	1	1
Oxynator	-	-	-	-	-	-	•	•	•	•
Ultraviolet	•	•	•	•	•	•	-	-	-	-
Aromatherapy	•	-	•	•	•	-	-	-	-	-
Chromotherapy	5 LEDs + light Tab	5 LEDs + light Tab	5 LEDs + light Tab	5 LEDs + light Tab	5 LEDs + light Tab	5 LEDs + light Tab	1 LED	1 LED	1 LED	1 LED
Structure and Cover										
High-resistance metal structure	•	•	•	•	•	•	•	•	•	•
Insulating ABS base	•	•	•	•	•	•	•	•	•	•
Isothermal cover	•	•	•	•	•	•	•	•	•	•
Technical equipment										
Filter pump	200 W	200 W	200 W	200 W	200 W	200 W	200 W	200 W	-	-
Massage pump	1.8 kW / 2.5 HP	1.8 kW / 2.5 HP	2 x 2.2 kW / 3 HP	2 x 1.8 kW / 2.5 HP	2 x 1.8 kW / 2.5 HP	2.2 kW / 3 HP	2 x 1.8 kW / 2.5 HP	1 x 1.8 kW / 2.5 HP	1,8 kW / 2,5 HP, 2 Vel	1,8 kW / 2,5 HP, 2 Vel.
Blower pump	1150 W	1150 W	400 W	400 W	400 W	-	-	400 W	-	400 W
Electric heater	3 kW	3 kW	3 kW	3 kW	3 kW	3 kW	3 kW	3 kW	3 kW	3 kW
Power consumption and capacity										
Consumption in low amps (W)	3400 W	3400 W	5200 W	4400 W	4400 W	3400 W	3780 W	3400 W	3.400 W	3400 W
Required power (A) at 230 V	14.6 A	14.6 A	22.4 A	19.1 A	19.1 A	14.6 A	16.8 A	14.6 A	14.6 A	14.6 A
230 V or 400 V III connection	•	•	•	•	•	•	•	•	•	•
Water capacity (litres)	975 l	975 l	1.610 l	1.138 l	1.138 l	780 l	930 l	930 l	780 l	935 l
Spa weight (Empty / Full)	450 kg / 1425 kg	450 kg / 1425 kg	378 kg / 1988 kg	327 kg / 1227 kg	327 kg / 1465 kg	229 kg / 1009 kg	327 kg / 1257 kg	327 kg / 1257 kg	307 kg / 1087kg	246 kg / 1181 kg

Model comparison

							
	Swimspa range				IN-GROUND range		
MODELS	Swimspa Dual	Swimspa Mediterranea	Swimspa Creta	Swimspa Compact	Evolution 70	Thalassa E	Ronda 30
Code	74238	64414	67203	69128	49722	78678	49859

General Information

Size cm (± 2 cm)	600 x 230 x 138	500 x 230 x 138	400 x 230 x 138	400 x 230 x 138	216 x 216 x 90	216 x 216 x 90	Ø 205
Places (Seats/Loungers)	1 Vertical + 4 (2 / 2)	4 (2 / 2)	4 (2 / 1 / 1)	1 Vertical	5 (3 / 2)	6 (5 / 1)	5 (5 / 0)
Graphite Cabinet	-	-	-	-	-	-	-
Coastal Grey cabinet	YES	YES	YES	YES	-	-	-
Thunder Cabin	-	-	-	-	-	-	-
Creek Cabinet	-	-	-	-	-	-	-
Butterfly Cabinet	-	-	-	-	-	-	-
Urban Grey	Optional	Optional	Optional	Optional	-	-	-
Solid surface Cabinet	-	-	-	-	-	-	-
Without cabinet	Optional	Optional	Optional	Optional	Yes	Yes	Yes

Options

EcoSpa thermal insulation	Optional	Optional	Optional	Optional	-	-	-
Nordic Insulation	-	-	-	-	-	-	-
Bluetooth Audio system	Optional (Sist. 4.1)	Optional (Sist. 4.1)	Optional (Sist. 4.1)	Optional (Sist. 4.1)	-	-	-
LumiPlus LED lighting system	•	•	•	•	-	-	-
Stainless steel jets	•	•	•	•	•	•	•
Stainless steel bar	•	•	•	•	-	-	-
Wi-Fi Spa Control	Optional	Optional	Optional	Optional	-	-	-
Blue Connect Plus	Optional	Optional	Optional	Optional	Optional	Optional	Optional
Rowing Kit	Optional. Code: 74496	-	Optional	-	-	-	-

Configurations

No of jets	16 + 5 Turbo Jets + 30 Jets	27 + 5 Turbo Jets	54 + 4 Turbo Jets	16+5 Turbo Jets	56	28	20 + 10
No. of blower nozzles	-	-	-	-	16	16	-
Waterfalls	-	1	-	-	-	-	-
Headrests	3	1	3	-	3	3	-
Touch Panel	2	1+aux	1	1	1+ aux	1	1
Oxynator	-	-	-	-	-	-	-
Ultraviolet	Yes	Yes	Yes	Yes	-	-	-
Aromatherapy	-	-	-	-	-	-	-
Chromotherapy	5 LEDs + light Tab	5 LEDs + light Tab	5 LEDs + light Tab	5 LEDs + light Tab	Yes	1 LED (CHROMOTHERAPY)	1 LED (CHROMOTHERAPY)
Structure and Cover							
High-resistance metal structure	•	•	•	•	•	•	•
Insulating base	•	•	•	•	Yes	Yes	Yes
Isothermal cover	•	•	•	•	•	Optional	Optional

Technical equipment

Filter pump	400 W + 200 W	400 W	400 W	400 W	600 W	600 W	600 W
Massage pump	3 x 2.2 kW / 3 HP + 2.2 kW / 3 HP	3 x 2.2 kW / 3 HP	3 x 2.2 kW / 3 HP	3 x 2.2 kW / 3 HP	2 x 2.2 kW / 3 HP	1 x 1.8 kW / 2.5 HP	1 x 1.8 kW / 2.5 HP
Blower pump	-	-	-	-	900 W	900 W	900 W
Electric heater	3 kW + 3 kW	3 kW	3 kW	3 kW	3 kW	3 kW	3 kW

Power consumption and capacity

Consumption in low amps (W)	9500 W	7000 W	7000 W	7000 W	5927 W	3650 W	3650 W
Required power (A) at 230 V	41.3 A	30.4 A	30.4 A	30.4 A	25.8 A	15.9 A	15.9 A
230 V or 400 V III connection	•	•	•	•	•	•	•
Water capacity (litres)	6780 l	8500 l	6000 l	6000 l	1610 l	980 l	780 l
Spa weight (Empty / Full)	1379 kg / 8159 kg	1177 kg / 9677 kg	1177 kg / 7177 kg	1150 kg / 7150 kg	378 Kg / 1988 Kg	330 kg / 1310 kg	307 kg / 1445 kg

Pure - Code 68450



White (44)
Solid surface Cabinet



TECHNICAL FEATURES

Size in cm (± 2cm)	220 x 220 x 78
Positions (Seats / Loungers)	4 (4 / -)
Jets + blower nozzles	27 + 12
Maximum consumption in low amp - (A) at 230 V	3400 W - 14.6 A

Spa coding with options generated from the table on page 483.

Options:

- Audio Bluetooth 4.1
- Nordic Insulation
- Wi-Fi Touch Panel
- Blue Connect Plus

Code	Standard Pack	Standard weight in kg	Standard volume in m ³
------	---------------	-----------------------	-----------------------------------

PURE

- White Solid Surface Cabinet + PureLine + ECOSpa
- White Solid Surface Cabinet + PureLine + Bluetooth Audio+ ECOSpa

68450SS336	-	-	-
68450SS337	-	-	-

New'Art - Code 68449



White (44)
Solid surface Cabinet



TECHNICAL FEATURES

Size in cm (± 2cm)	220 x 220 x 78
Positions (Seats / Loungers)	5 (3 / 2)
Jets + blower nozzles	28 + 14
Maximum consumption in low amp - (A) at 230 V	3400 W - 14.6 A

Spa coding with options generated from the table on page 483.

Options:

- Audio Bluetooth 4.1
- Nordic Insulation
- Wi-Fi Touch Panel
- Blue Connect Plus

Code	Standard Pack	Standard weight in kg	Standard volume in m ³
------	---------------	-----------------------	-----------------------------------

NEW'ART

- White Solid Surface Cabinet + PureLine + ECOSpa
- White Solid Surface Cabinet + PureLine + Bluetooth Audio + ECOSpa

68449SS336	-	-	-
68449SS337	-	-	-

Evolution - Code 32474



White Colour (44)
Graphite Cabinet



TECHNICAL FEATURES

Size in cm (± 2cm)	233 x 233 x 90
Positions (Seats / Loungers)	5 (3 / 2)
Jets + blower nozzles	56+16+2 water fountains
Maximum consumption in low amp - (A) at 230 V	5200 W - 22.4 A

Spa coding with options generated from the table on page 483.

Options:

- ECOSpa
- Audio Bluetooth 4.1
- Nordic Insulation
- Wi-Fi Touch Panel
- Blue Connect Plus

Code	Standard Pack	Standard weight in kg	Standard volume in m ³
------	---------------	-----------------------	-----------------------------------

EVOLUTION

- Metallic structure without furniture + Stainless steel jets + LumiPlus + Cover
- Graphite cabinet + Stainless steel jets + Stainless steel bar + LumiPlus + Cover
- Thunder cabinet + Stainless steel jets + Stainless steel bar + LumiPlus + Cover
- Creek cabinet + Stainless steel jets + Stainless steel bar + LumiPlus + Cover
- Butterfly Cabinet + Stainless Steel Jets + Stainless Steel Bar + LumiPlus + Cover

32474A4320	-	-	-
32474AK332	-	-	-
32474AR332	-	-	-
32474AT332	-	-	-
32474AW332	-	-	-

Atlantida 70 - Code 62399



Silver Colour (27)
Thunder Cabinet



TECHNICAL FEATURES

Size in cm (± 2cm)	216 x 216 x 90
Positions (Seats / Loungers)	5 (3 / 2)
Jets + blower nozzles	52 + 14 + 2 waterfalls
Maximum consumption in low amp - (A) at 230 V	4400 W / 19.1 A

Spa coding with options generated from the table on page 483.

Options:

- ECOSpa
- Audio Bluetooth 4.1
- Nordic Insulation
- Wi-Fi Touch Panel
- Blue Connect Plus

Code	Standard Pack	Standard weight in kg	Standard volume in m ³
------	---------------	-----------------------	-----------------------------------

ATLANTIDA 70

- Metallic structure without furniture + Stainless steel jets + LumiPlus + Cover
- Graphite cabinet + Stainless steel jets + Stainless steel bar + LumiPlus + Cover
- Thunder cabinet + Stainless steel jets + Stainless steel bar + LumiPlus + Cover
- Creek cabinet + Stainless steel jets + Stainless steel bar + LumiPlus + Cover
- Butterfly Cabinet + Stainless Steel Jets + Stainless Steel Bar + LumiPlus + Cover

62399A4320	-	-	-
62399AK332	-	-	-
62399AR332	-	-	-
62399AT332	-	-	-
62399AW332	-	-	-

Pacific 70 - Code 69130



White Colour (44)
Butterfly Cabinet



TECHNICAL FEATURES

Size in cm (± 2cm)	216 x 216 x 90
Positions (Seats / Loungers)	6 (5 / 1)
Jets + blower nozzles	51+10 + 2 waterfalls
Maximum consumption in low amp - (A) at 230 V	4400 W / 19.1 A

Spa coding with options generated from the table on page 483.

Options:

- ECOSpa
- Audio Bluetooth 4.1
- Nordic Insulation
- Wi-Fi Touch Panel
- Blue Connect Plus

Code	Standard Pack	Standard weight in kg	Standard volume in m ³
------	---------------	-----------------------	-----------------------------------

PACIFIC 70

- Metallic structure without furniture + Stainless Steel Jets + LumiPlus + Cover
- Graphite Cabinet + Stainless Steel Jets + Stainless Steel Bar + LumiPlus + Cover
- Thunder Cabinet + Stainless Steel Jets + Stainless Steel Bar + LumiPlus + Cover
- Creek Cabinet + Stainless Steel Jets + Stainless Steel Bar + LumiPlus + Cover
- Butterfly Cabinet + Stainless Steel Jets + Stainless Steel Bar + LumiPlus + Cover

69130A4320	-	-	-
69130AK332	-	-	-
69130AR332	-	-	-
69130AT332	-	-	-
69130AW332	-	-	-

Ocean 70 - Code 69863



White (44)
Creek Cabinet



TECHNICAL FEATURES

Size in cm (± 2cm)	216 x 167 x 74
Positions (Seats / Loungers)	3 (1 / 2)
Jets	42
Maximum consumption in low amp - (A) at 230 V	3400 W / 14.6 A

Spa coding with options generated from the table on page 483.

Options:

- ECOSpa
- Audio Bluetooth 4.1
- Nordic Insulation
- Wi-Fi Touch Panel
- Blue Connect Plus

Code	Standard Pack	Standard weight in kg	Standard volume in m ³
------	---------------	-----------------------	-----------------------------------

OCEAN 70

- Metallic structure without furniture + Stainless Steel Jets + LumiPlus + Cover
- Graphite Cabinet + Stainless Steel Jets + Stainless Steel Bar + LumiPlus + Cover
- Thunder Cabinet + Stainless Steel Jets + Stainless Steel Bar + LumiPlus + Cover
- Creek Cabinet + Stainless Steel Jets + Stainless Steel Bar + LumiPlus + Cover
- Butterfly Cabinet + Stainless Steel Jets + Stainless Steel Bar + LumiPlus + Cover

69863A4320	-	-	-
69863AK332	-	-	-
69863AR332	-	-	-
69863AT332	-	-	-
69863AW332	-	-	-

Select E - Code 76894



White (44)
Thunder Cabinet

TECHNICAL FEATURES

Size in cm (± 2cm)	216 x 216 x 90
Positions (Seats / Loungers)	6 (5 / 1)
Jets	51 + 1 waterfall
Maximum consumption in low amp - (A) at 230 V	3.780 W / 16.8 A

Spa coding with options generated from the table on page 483.

- Options:
- LumiPlus
 - ECOSpa
 - Audio Bluetooth 2.1

Code	Standard Pack	Standard weight in kg	Standard volume in m ³
------	---------------	-----------------------	-----------------------------------

SELECT E

- SELECT E Metallic structure without furniture + Stainless steel jets + Cover
- SELECT E Graphite cabinet + Stainless steel jets + Cover
- SELECT E Thunder cabinet + Stainless steel jets + Cover

76894A4300	-	-	-
76894AP300	-	-	-
76894AQ300	-	-	-

Emotion E - Code 69122



White (44)
Thunder cabinet

TECHNICAL FEATURES

Size in cm (± 2cm)	216 x 216 x 90
Positions (Seats / Loungers)	5 (3 / 2)
Water Jets	32
Air Jets	12
Maximum consumption in low amp - (A) at 230 V	3.400 W - 14.8 A

Spa coding with options generated from the table on page 483.

- Options:
- ECOSpa
 - LumiPlus
 - Audio Bluetooth 2.1

Code	Standard Pack	Standard weight in kg	Standard volume in m ³
------	---------------	-----------------------	-----------------------------------

EMOTION E

- Metallic structure without furniture + Stainless steel jets + Cover
- Graphite cabinet + Stainless steel jets + Cover
- Thunder cabinet + Stainless steel jets + Cover

69122A4300	-	-	-
69122AP300	-	-	-
69122AQ300	-	-	-

Equilibre E - Code 73076



White (44)
Infinity Cabinet

TECHNICAL FEATURES

Size in cm (± 2cm)	216 x 167 x 74
Positions (Seats / Loungers)	3 (1 / 2)
Jets	26
Maximum consumption in low amp - (A) at 230 V	3400 W - 14.8 A

Spa coding with options generated from the table on page 483.

- Options:
- ECOSpa

Code	Standard Pack	Standard weight in kg	Standard volume in m ³
------	---------------	-----------------------	-----------------------------------

EQUILIBRE E

Metallic structure without furniture + stainless steel jets + cover
Infinity cabinet + stainless steel jets + cover

73076A4300	-	-	-
73076AC300	-	-	-

Balance E - Code 74134



White (44)
Infinity Cabinet

TECHNICAL FEATURES

Size in cm (± 2cm)	198 x 198 x 74
Positions (Seats / Loungers)	5 (3 / 2)
Jets	31
Maximum consumption in low amp - (A) at 230 V	3400 W - 14.6 A

Spa coding with options generated from the table on page 483.

- Options:
- ECOSpa
 - Audio Bluetooth 2.1

Code	Standard Pack	Standard weight in kg	Standard volume in m ³
------	---------------	-----------------------	-----------------------------------

BALANCE E

Metallic structure without furniture + stainless steel jets + cover
Infinity cabinet + stainless steel jets + cover

74134A4300	-	-	-
74134AC300	-	-	-

Swimspa Dual - Code 74238



White (44)
coastal grey cabinet



White (44)
Urban Grey Cabinet



TECHNICAL FEATURES

Size in cm (± 2cm)	600 x 230 x 138
Places (Seats/Loungers)	1 Vertical 4 (2/2)
- Swimming area: - Spa area:	30 Jets 16+5 Turbo jets
Maximum consumption in low amp - (A) at 230 V	9500 W / 41.3 A

Coding generated with the initial table on page 483.

Options:

- ECOSpa
- Audio Bluetooth 4.1
- Blue Connect Plus
- Rowing Kit code 74496
- Wi-Fi Spa Control

Code	Standard Pack	Standard weight in kg	Standard volume in m ³
------	---------------	-----------------------	-----------------------------------

DUAL SWIMSPA

- Coastal Grey Cabinet + Stainless Steel Jets + LumiPlus + Cover
- Urban Grey Cabinet + Stainless Steel Jets + LumiPlus + Cover
- Metallic structure without furniture + Stainless steel jets + LumiPlus + Cover

74238A1320	-	-	-
74238AB320	-	-	-
74238A4320	-	-	-

Swimspa Mediterranea - Code 64414



White (44)
Coastal Grey cabinet



White (44)
Urban Grey Cabinet



TECHNICAL FEATURES

Size in cm (± 2cm)	500 x 230 x 138
Positions (Seats / Loungers)	4 (2 / 2)
Jets	27 jets + 5 Turbo jets
Maximum consumption in low amp - (A) at 230 V	7000 W / 30.5 A

Coding generated with the initial table on page 483.

Options:

- ECOSpa
- Audio Bluetooth 4.1
- Blue Connect Plus
- Wi-Fi Spa Control



Code	Standard Pack	Standard weight in kg	Standard volume in m ³
------	---------------	-----------------------	-----------------------------------

MEDITERRANEA SWIMSPA

- Coastal Grey Cabinet + Stainless Steel jets + LumiPlus + Cover
- Urban Grey Cabinet + Stainless Steel jets + LumiPlus + Cover
- Metallic structure without furniture + Stainless Steel jets + LumiPlus + Cover
- For Kit + Stainless Steel jets + Colour LEDs + Digital Control Panel + Cover

64414A1320	-	-	-
64414AB320	-	-	-
64414A4320	-	-	-
65353SE311	-	-	-

Model 65353 must be supplied with the compact kit, code 64972CE001.

We reserve the right to change, wholly or partially, the features of our products and the contents of this document, without prior notice

Swimspa Creta - Code 67203



White (44)
Coastal Grey cabinet



White (44)
Urban Grey Cabinet

TECHNICAL FEATURES

Size in cm (± 2cm)	400 x 230 x 138
Positions (Seats / Loungers)	4 (2 / 1 / 1)
Jets + blower nozzles	54 jets + 4 Turbo jets
Maximum consumption in low amp - (A) at 230 V	7000 W / 30.5 A



Coding generated with the initial table on page 483.

Options:

- ECOSpa
- Audio Bluetooth 4.1
- Blue Connect Plus
- Rowing Kit
- Wi-Fi Spa Control

Code	Standard Pack	Standard weight in kg	Standard volume in m ³
------	---------------	-----------------------	-----------------------------------

CRETA SWIMSPA

- Coastal Grey Cabinet + Stainless Steel jets + LumiPlus + Cover
- Urban Grey Cabinet + White LumiPlus
- Metallic structure without furniture + Stainless steel jets + LumiPlus + Cover
- For Kit + Stainless Steel jets + Colour LEDS + Digital Control Panel + Cover

67203A1320	-	-	-
67203AB320	-	-	-
67203A4320	-	-	-
67587SE311	-	-	-

Model Creta must be supplied with the compact kit, code 64972CE001

Swimspa Compact - Code 69128



White (44)
Coastal Grey cabinet



White (44)
Urban Grey Cabinet

TECHNICAL FEATURES

Size in cm (± 2cm)	400 x 230 x 138
Positions (Seats / Loungers)	1 Vertical
Jets + blower nozzles	16+5 Turbo Jets
Maximum consumption in low amp - (A) at 230 V	7000 W / 30.5 A

Coding generated with the initial table on page 483.

Options:

- EcoSpa
- Audio Bluetooth 4.1
- Blue Connect Plus
- Wi-Fi Spa Control

Code	Standard Pack	Standard weight in kg	Standard volume in m ³
------	---------------	-----------------------	-----------------------------------

COMPACT SWIMSPA

- Coastal Grey Cabinet + Stainless Steel Jets + LumiPlus + Cover
- Urban Grey Cabinet + White LumiPlus
- Metallic structure without furniture + Stainless Steel Jets + LumiPlus + Cover
- For kit + Stainless Steel jets + color LEDS + Digital Control Panel+ Cover

69128A1320	-	-	-
69128AB320	-	-	-
69128A4320	-	-	-
69129SE311	-	-	-

Model Compact must be supplied with the compact kit, code 64972CE001

We reserve the right to change, wholly or partially, the features of our products and the contents of this document, without prior notice

Evolution 70 inground - code 49722



White (44)

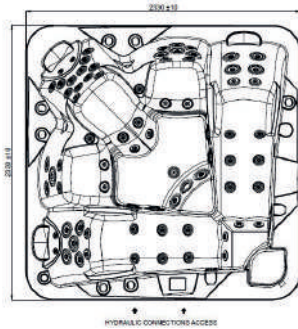

TECHNICAL FEATURES

Size	233 x 233 x 90
Jets	56+16
Drain	1
Electronic control panel	2
Positions (Seats / Loungers)	5 (3 / 2)
Water Capacity	1.610 l
Empty/full Spa weight	378 Kg / 1.988 Kg
Headrest	3
Cover	Yes
LED Chromotherapy projector	Yes
Jets	Stainless steel
Aromatherapy	No
Cascade	No
Metallic structure	Yes

Code	Standard Pack	Standard weight in kg	Standard volume in m ³
------	---------------	-----------------------	-----------------------------------

EVOLUTION 70

- Standard + light + digital control panel
- Standard + light + digital control panel + cover

49722SE310	-	-	-
49722SE311	-	-	-

The Spa must be supplied with the filter kit, code 49849CE000

Thalassa E inground - code 78678



Blue Marble (46)

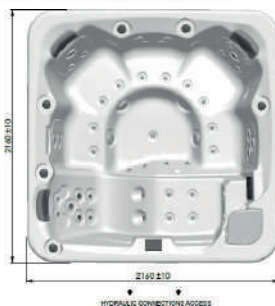

TECHNICAL FEATURES

Size	216 x 216 x 90
Jets	28+16
Drain	1
Electronic control panel	Yes
Positions (Seats / Loungers)	6 (5 / 1)
Water Capacity	980 l
Empty/full Spa weight	330 Kg / 1310 Kg
Headrest	3
Cover	Yes
LED Chromotherapy projector	Yes
Jets	Stainless steel
Cascade	No
Metallic structure	Yes

Code	Standard Pack	Standard weight in kg	Standard volume in m ³
------	---------------	-----------------------	-----------------------------------

THALASSA E

- Standard + Light + Digital control panel
- Standard + Light + Digital control panel + cover

78678SE310	-	-	-
78678SE311	-	-	-

The Spa must be supplied with the filter kit, code 41993CE000 or 41993CE001.

Spa cover sold separately. See section "Spa accessories".

We reserve the right to change, wholly or partially, the features of our products and the contents of this document, without prior notice

Ronda 30 - Code 49859



White (44)

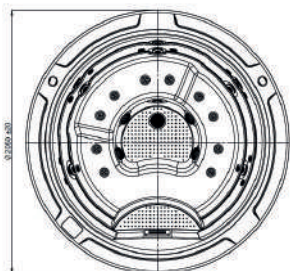

TECHNICAL FEATURES

Size	Ø 205 (± 2 cm)
Jets + nozzles	20 + 10
Drain	1
Digital control panel	Yes
Positions (Seats / Loungers)	5 (5 / 0)
Water Capacity	780 l
Empty/full Spa weight	307 kg / 1445 kg
Chromotherapy LED light	Yes
Jets	Stainless steel
Metallic structure	Yes
Cover	Yes

Fully fitted with pipe assembly, skimmer, main drain, filtering, hydromassage and blower nozzles, hydromassage digital control buttons and two Venturi inlets. With adjustable bracket for easy installation.

Code	Standard Pack	Standard weight in kg	Standard volume in m ³
------	---------------	-----------------------	-----------------------------------

RONDA 30

- Standard + Light + Digital control panel
- Standard + Light + Digital control panel + Cover

49859SE310	-	-	-
49859SE311	-	-	-

The Spa must be supplied with the filter kit. code 41993CE000 or 41993CE001.

COMPACT FILTRATION FOR SPAS

Compact kit

for Thalassa, Evolution 70 and Ronda 30



	Code	Standard Pack	Standard weight in kg	Standard volume in m ³
Compact kit	41993CE000	-	-	-
Compact kit	41993CE001	-	-	-
Compact kit	41993	-	-	-

TECHNICAL FEATURES

Code	Oxynator	Digital control panel*	Compact weight	Assembly volume	Max. spa volume	Massage pump	
41993CE000		-	60 kg	2.05 m ³	1000 l	2.2 kW	
41993CE001	•	-					
Code	Filter (mm)	Filtration pump	Blower pump	Electric heater	Voltage	Power requirements	Length x width x height
41993	500	0.6 kW 7000 l/h	0.9 kW	3 kW	230 V or 400 V III	3852 W / 16.7 A*	115 x 75 x 105 mm

Consumption in Low Amp at 230 V.

* In the Spa + Compact Kit option, the digital control option must be selected.

Compact kit

for Evolution 70 inground



	Code	Standard Pack	Standard weight in kg	Standard volume in m ³
Compact kit	41849	-	-	-

TECHNICAL FEATURES

Code	Oxynator	Digital control panel*	Chromotherapy	Compact weight	Assembly volume	Max. spa volume	Massage pump
41849	Optional	-	•	70 kg	2.05 m ³	1610 l	2.2 kW x 2

* In the Spa + Compact Kit option, the digital control option must be selected.

Compact kit

for Swimspa Mediterranea



	Code	Standard Pack	Standard weight in kg	Standard volume in m ³
Compact kit	64972CE001	-	-	-
Compact kit	64972	-	-	-

TECHNICAL FEATURES

Code	Oxynator	Digital control panel*	Chromotherapy	Compact weight	Assembly volume	Max. spa volume	Massage pump
64972CE001	•	-	•	70 kg	2.05 m ³	8500 l	3 x 2.2 kW / 3hp
Code	Filter (mm)	Filtration pump	Electric heater	Voltage	Power requirements	Length x width x height	
64972	500	0.6 kW 7000 l/h	3 kW	230 V or 400 V III	7352 W / 31.9 A*	114 x 100 x 112 mm	

Consumption in Low Amp at 230 V.

* In the Spa + Compact Kit option, the digital control option must be selected.

Covers for spas



Portable spa cover

DESCRIPTION

	Code	Standard Pack	Standard weight in kg	Standard volume in m ³
THALASSA E spa cover	65977	1	17	0.40
EVOLUTION 70 inground spa cover	32690	1	16	0.36
RONDA 30 spa cover	51288	1	15	0.27

Cover Stand



DESCRIPTION

Metal Stand for simple handling of the cover.

	Code	Standard Pack	Standard weight in kg	Standard volume in m ³
Cover Stand	28462	1	10	0.118

Spa access steps

	Code	Standard Pack	Standard weight in kg	Standard volume in m ³
Basic staircase coastal grey	60194	1	5	0.07
Swimspa staircase	56918CL01	1	35	0.59
Synthetic wood staircase				
In Graphite	42002CL0K	1	15	0.09
In Thunder	42002CL0R	1	15	0.09
In Creek	42002CL0T	1	15	0.09
In Butterfly	42002CL0W	1	15	0.09

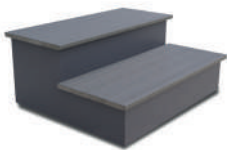

42002CL0K



60194



56918CL01



42002CL0R



42002CL0T

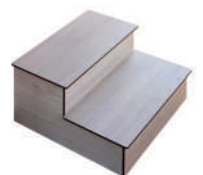

42002CL0W

Spa parasol in Cameo with LED



	Code	Standard Pack	Standard weight in kg	Standard volume in m ³
Spa parasol in Cameo with LED	60220	2	15	2

Portable spa handrail holder



	Code	Standard Pack	Standard weight in kg	Standard volume in m ³
Portable spa handrail holder	60226	2	8	0.95

Spa filter cartridge cleaner



	Code	Standard Pack	Standard weight in kg	Standard volume in m ³
Spa filter cartridge cleaner	60197	1	2	0.04

2 1/2" adjustable jet



DESCRIPTION

Regulates proportion of air-water outlet. 50 mm diameter water inlet and 32 mm air inlet. Flow: 4 m³/hour. Pressure 0.8 a.t.m.

Code	Standard Pack	Standard weight in kg	Standard volume in m ³
32641	12	7.625	0.028

2" threaded jet



DESCRIPTION

Water inlet diameter of 50 mm and air inlet diameter of 32 mm. Flow rate of 4 m³/hour. Atm pressure of 0.8.

Code	Standard Pack	Standard weight in kg	Standard volume in m ³
33586	12	7.625	0.028

2" jet thread for liner



DESCRIPTION

Water inlet diameter of 50 mm and air inlet diameter of 32 mm. Flow rate of 4 m³/hour Atm pressure of 0.8.

Code	Standard Pack	Standard weight in kg	Standard volume in m ³
70532	12	7.625	0.028

2" main drain



DESCRIPTION

With elbow for gluing to Ø 50 mm pipe.

Code	Standard Pack	Standard weight in kg	Standard volume in m ³
04042	15	4.8	0.028

Adjustable air inlet



DESCRIPTION

1" for air regulation to Venturi system for jet function.

Code	Standard Pack	Standard weight in kg	Standard volume in m ³
04045	25	6.0	0.028



Adjustable silent air inlet

DESCRIPTION

Silent Venturi for jet air flow control. Air intake is through embedded part. Attaches to air distributor code 33937.

Code	Standard Pack	Standard weight in kg	Standard volume in m ³
33938	25	8.5	0.028



5 outlet air distributor for Venturi system

DESCRIPTION

5 outlet air distributor for gluing to Venturi system with code 33938. Outlets for clamping a flexible hosepipe of 10 mm inner diameter.

Code	Standard Pack	Standard weight in kg	Standard volume in m ³
33937	25	8.5	0.028



6 outlet air distributor for Venturi system

DESCRIPTION

6 outlet air distributor to attach to pipes with a 10 mm inner diameter and glue to 15 mm pipes.

Code	Standard Pack	Standard weight in kg	Standard volume in m ³
33936	25	8.5	0.028



10 outlet air distributor

DESCRIPTION

10 outlet air distributor to attach to pipes with a 10 mm inner diameter and glue to 50 mm pipes.

Code	Standard Pack	Standard weight in kg	Standard volume in m ³
35346	25	8.5	0.028

4 water outlet manifold



DESCRIPTION

Manifold for gluing to 50 mm pipe, 4 outlets for clamping a hosepipe of 20 mm inner diameter.

Code	Standard Pack	Standard weight in kg	Standard volume in m ³
33934	25	8.5	0.028

8 water outlet manifold



DESCRIPTION

Manifold for gluing to 50 mm pipe, 8 outlets for clamping a hosepipe of 20 mm inner diameter.

Code	Standard Pack	Standard weight in kg	Standard volume in m ³
33935	25	8.5	0.028

Threaded blower nozzle



DESCRIPTION

For air distribution into the SPA from the blowers. Flow rate 5.4 to 7.5 m³/h.

	Code	Standard Pack	Standard weight in kg	Standard volume in m ³
White plastic front panel	27602	80	1.6	0.03
Stainless steel front panel	43440	80	1.6	0.03

Blower nozzle for gluing



DESCRIPTION

For air distribution into the SPA from the blowers. Flow rate 5.4 to 7.5 m³/h.

	Code	Standard Pack	Standard weight in kg	Standard volume in m ³
White plastic front panel	28460	80	1.6	0.03
Stainless steel front panel	43441	80	1.6	0.03

Blower nozzle lateral outlet 3/8"



DESCRIPTION

For air distribution into the SPA from the blowers. Flow rate 5.4 to 7.5 m³/h.

	Code	Standard Pack	Standard weight in kg	Standard volume in m ³
White plastic front panel	34318	80	1.6	0.03
Stainless steel front panel	43442	80	1.6	0.03

2" return unit



DESCRIPTION

For return line and massage.

	Code	Standard Pack	Standard weight in kg	Standard volume in m ³
	04034	25	5.0	0.028

Pneumatic push button



DESCRIPTION

For starting and stopping massage and hydromassage functions.

	Code	Standard Pack	Standard weight in kg	Standard volume in m ³
For max. 15 m	04047	20	0.5	0.028
For max. 7 m simple	04048	40	1.6	0.028
For max. 7 m simple, with thread	09667	20	0.5	0.028

Plastic tube

DESCRIPTION

For pneumatic signal from press button to switch. Inner Ø 3.5 mm.

	Code	Standard Pack	Standard weight in kg	Standard volume in m ³
	04054	50	3.33	0.006

Stainless steel accessories should not be used in pools with salt electrolysis systems

Rotating jet



DESCRIPTION

Flow rate 2 to 2.5 m³/h.

Code	Standard Pack	Standard weight in kg	Standard volume in m ³
20297	25	3.33	0.028

Twin rotating jet



DESCRIPTION

Flow rate 2 to 2.5 m³/h.

Code	Standard Pack	Standard weight in kg	Standard volume in m ³
20296	25	3.83	0.028

Rotating jet housing



Code	Standard Pack	Standard weight in kg	Standard volume in m ³
20299	15	3.33	0.028

Jet housing for linear pool



Code	Standard Pack	Standard weight in kg	Standard volume in m ³
63144	12	3.33	0.028

2 1/2" wall conduit for rotating jet



DESCRIPTION

Made up of: The jet body, 20 cm wall conduit, niche, threaded fitting, front body. Jet not included.

Flow rate 5 m³/h at 1 bar.

Code	Standard Pack	Standard weight in kg	Standard volume in m ³
20295	4	4	0.018

Chrome accessories only suitable for tubs that do not use any chemical treatment. Not suitable for pools.

Pool Jet accessories are designed for pools that have a hydromassage section.



Pool Jet 1 Directional Jet

DESCRIPTION

Flow rate 2.4 to 3.6 m³/h. Accessories compatible with 2½" handrail for Pool Jet.

	Code	Standard Pack	Standard weight in kg	Standard volume in m ³
Stainless steel finish*	63148	25	3.83	0.028
White finish	63149	25	3.83	0.028

Pool Jet 1 Rotating Jet

DESCRIPTION

Flow rate 2.4 to 3.6 m³/h. Accessories compatible with 2½" handrail for Pool Jet.

	Code	Standard Pack	Standard weight in kg	Standard volume in m ³
Stainless steel finish*	63150	25	3.83	0.028
White finish	63151	25	3.83	0.028

Pool Jet 2 Rotating Jets

DESCRIPTION

Flow rate 2.4 to 3.6 m³/h. Accessories compatible with 2½" handrail for Pool Jet.

	Code	Standard Pack	Standard weight in kg	Standard volume in m ³
Stainless steel finish*	63152	25	3.83	0.028
White finish	63153	25	3.83	0.028

Pool Jet Rotating Beehive

DESCRIPTION

Flow rate 2.4 to 3.6 m³/h. Accessories compatible with 2½" handrail for Pool Jet.

	Code	Standard Pack	Standard weight in kg	Standard volume in m ³
Stainless steel finish*	63154	25	3.83	0.028
White finish	63155	25	3.83	0.028

Wall conduit for Pool Jet

DESCRIPTION

Made up of: The jet Straight body (20 mm Air x 32 mm Water), 20 cm wall conduit, niche, front body. Jet not included.

	Code	Standard Pack	Standard weight in kg	Standard volume in m ³
	63146	4	4	0.018

Chrome accessories only suitable for tubs that do not use any chemical treatment. Not suitable for pools.

1 1/2" main drain

ASTRALPOOL

DESCRIPTION

With elbow for gluing Ø 50 mm pipe.

	Code	Standard Pack	Standard weight in kg	Standard volume in m ³
Chrome-plated bronze front panel	04104	3	7.5	0.028

Adjustable air inlet

ASTRALPOOL

DESCRIPTION

3/4" to control air massage to Venturi system for jet function.

	Code	Standard Pack	Standard weight in kg	Standard volume in m ³
Chrome-plated bronze front panel	04108	10	9.0	0.028
White plastic front panel	04110	10	3.0	0.028

Pneumatic push button

ASTRALPOOL

DESCRIPTION

For starting and stopping massage and hydromassage functions.

	Code	Standard Pack	Standard weight in kg	Standard volume in m ³
Chrome-plated bronze front panel	04111	10	6.0	0.028
White plastic front panel	04113	12	6.0	0.028

Blower Inlet

ASTRALPOOL

DESCRIPTION

For minispa air distribution from the blower. 1 1/2" thread.

	Code	Standard Pack	Standard weight in kg	Standard volume in m ³
Chrome-plated bronze front panel	04114	20	7.5	0.028

Chrome accessories only suitable for tubs that do not use any chemical treatment.
Not suitable for pools.



1 1/4" jet with adaptor to water return

DESCRIPTION

Jet with adaptor to return water to pipe. Also adaptor to connect to water return and air circulation pipe, solvent for inner Ø 32 mm, directional.

	Code	Standard Pack	Standard weight in kg	Standard volume in m ³
Chrome-plated bronze front panel	04095	8	12.0	0.028
White plastic front panel	04097	12	12.0	0.028



1 1/4" jet

DESCRIPTION

With adaptor to connect to return water pipe and Venturi system to glue to Ø 32 mm pipe, directional.

	Code	Standard Pack	Standard weight in kg	Standard volume in m ³
Chrome-plated bronze front panel	04092	8	10.0	0.028
White plastic front panel	04094	24	5.0	0.028



1 1/4" return inlet

	Code	Standard Pack	Standard weight in kg	Standard volume in m ³
Built in chrome brass	04100	4	15.0	0.028
Built in white plastic	04103	12	3.5	0.028



Programmable digital thermostat



DESCRIPTION

To operate ON/OFF contactor.

Code	Standard Pack	Standard weight in kg	Standard volume in m ³
11288	20	0.5	0.003



Electric press button



DESCRIPTION

230 V 50 Hz.

Code	Standard Pack	Standard weight in kg	Standard volume in m ³
74467	1	1.5	0.003



Electropneumatic equipment



DESCRIPTION

With two switches. Up to 1.47 kW (2HP).

Code	Standard Pack	Standard weight in kg	Standard volume in m ³
04053	2	4.0	0.028



Pneumatic switch



DESCRIPTION

For starting and stopping massage and hydromassage functions.

	Code	Standard Pack	Standard weight in kg	Standard volume in m ³
Pneumatic switch	04050	25	1.0	0.028
Pneumatic switch and presostat	11290	6	0.5	0.028
Pneumatic presostat	11291	12	1.0	0.028

Continuous operation

lateral turbo blower pump



DESCRIPTION

Air pump designed for spas, hydromassage tubs and similar which produces a constant stream of air bubbles at medium and high air volume levels. It can also be used to stir up the filter bed, for example in backwash cycles where a low intensity air current is required. The filter casing and impeller are made from an injected aluminium alloy whilst the motor spindle is manufactured from stainless steel, with the impeller dynamically balanced and directly adapted to the spindle. The motors, 2 single phase or 3 phase for continuous use, are made from steel in compliance with CEI 2/3 1988 regulations, and feature IP54 external protection and class-F insulation. The pumps can be mounted horizontally or vertically. Moreover, since there is no contact between the mobile parts and the pump static discharges, neither lubrication nor maintenance is necessary and it also doesn't cause wear on the parts.

The turbines have a maximum working temperature of 40°C. Do not use in conjunction with aggressive, inflammable or explosive gases.

Model	Code	Frequency (Hz)	Power supply (V)	Phase	Flow rate (m ³ /h)	Maximum pressure (mbar)	Standard weight (kg)	Standard volume (m ³)
Blower 0.4 kW	33970	50	Δ 200-240 Y 345-415	3	80	130	10	0.045
Blower 0.5 kW		60	Δ 220-275 Y 380-480	3	98	170		
Blower 0.85 kW	35388	50	200-240	1	145	160	17	0.059
Blower 0.95 kW		60	200-240	1	175	160		
Blower 0.85 kW	35387	50	Δ 200-240 Y 345-415	3	145	160	16	0.045
Blower 0.95 kW		60	Δ 220-275 Y 380-480	3	175	160		
Blower 1.3 kW	31090	50	200-240	1	210	170	23	0.059
Blower 1.5 kW		60	200-240	1	255	140		
Blower 1.3 kW	31091	50	Δ 200-240 Y 345-415	3	210	170	22	0.059
Blower 1.5 kW		60	Δ 220-275 Y 380-480	3	255	140		
Blower 1.5 kW	33971	50	200-240	1	210	220	24	0.064
Blower 1.75 kW		60	200-240	1	255	220		
Blower 1.6 kW	31092	50	Δ 200-240 Y 345-415	3	210	220	23	0.064
Blower 2.1 kW		60	Δ 220-275 Y 380-480	3	255	220		
Blower 1.6 kW 2V	35389	50	Δ 200-240 Y 345-415	3	150	300	25	0.087
Blower 2.06 kW 2V		60	Δ 220-275 Y 380-480	3	180	310		
Blower 2.2 kW	31093	50	Δ 200-240 Y 345-415	3	318	230	30	0.097
Blower 2.55 kW		60	Δ 220-275 Y 380-480	3	376	220		
Blower 3.0 kW 2V	31094	50	Δ 200-240 Y 345-415	3	230	410	40	0.126
Blower 3.45 kW 2V		60	Δ 220-275 Y 380-480	3	275	400		
Blower 3.0 kW	31095	50	Δ 200-240 Y 345-415	3	318	280	36	0.097
Blower 3.45 kW		60	Δ 220-275 Y 380-480	3	376	280		
Blower 4.3 kW 2V	31096	50	Δ 345-415 Y 600-720	3	520	600	54	0.217
Blower 4.8 kW 2V		60	Δ 380-480 Y 660-720	3	385	320		
Blower 5.5 kW	31097	50	Δ 345-415 Y 600-720	3	530	320	63	0.16
Blower 6.3 kW		60	Δ 380-480 Y 660-720	3	620	340		
Blower 5.5 kW 2V	33972	50	Δ 345-415 Y 600-720	3	320	515	66	0.201
Blower 6.3 kW 2V		60	Δ 380-480 Y 660-720	3	385	530		
Blower 7.5 kW	31098	50	Δ 345-415 Y 600-720	3	530	400	66	0.16
Blower 8.6 kW		60	Δ 380-480 Y 660-720	3	620	400		
Blower 11 kW 2V	33973	50	Δ 345-415 Y 600-720	3	520	600	104	0.353
Blower 12.6 kW 2V		60	Δ 380-480 Y 660-720	3	620	600		
Blower 12.5 kW	33974	50	Δ 345-415 Y 600-720	3	1050	270	116	0.353
Blower 14.5 kW		60	Δ 380-480 Y 660-720	3	1250	260		

Intermittent operation

air blower, 900 W



	Code	Standard Pack	Standard weight in kg	Standard volume in m ³
0.90 kW flow 54 m ³ /h at 1.5 m water head	19289	1	3.5	0.028

Water pump



DESCRIPTION

ABS (25%) and fibreglass (75%) housing. A 0.37 kW (0.5 hp) motor. IP-55 electrical connection rating of 24 V 220 V 1~ 50Hz . 2" male suction connection. 1½" male return connection.

	Code	Standard Pack	Standard weight in kg	Standard volume in m ³
Water pump	04091	1	6.0	0.016

TECHNICAL FEATURES

Water head	m ³ /h
2	16.5
4	14.8
6	12.6
8	10
10	7

Intermittent operation

air blower



	Code	Standard Pack	Standard weight in kg	Standard volume in m ³
At 1 m water head				
0.74 kW, Flow 65 m ³ /h	06862	1	3.5	0.028
1.10 kW, Flow 133 m ³ /h	06863	1	3.5	0.028

Cala Pump



DESCRIPTION

Centrifugal pump for spas, backwashes and other applications.

- Pump body manufactured in polypropylene reinforced with fibreglass, resistant to pool chemical products thus guaranteeing long and excellent duration.
- Turbine in Noryl.
- Graphite and ceramic mechanical seal.
- AISI 316L stainless steel motor spindle.
- Enclosed motor, completely silent, with IP-55 protection at 2850 r.p.m. Single phase power voltage at 230V-50Hz or triphase at 230/400-50Hz.
- Versions from 1.5 to 4.5 HP.
- Suction and return connections for gluing hoses included with the pump.
- Suction and return at Ø63.

	Code	Standard Pack	Standard weight in kg	Standard volume in m ³
Single phase 1.1 kW Cala Pump	CA150M	1	15.0	0.058
Tri phase 1.1 kW Cala Pump	CA150T	1	15.0	0.058
Single phase 1.5 kW Cala Pump	CA200M	1	16.5	0.058
Tri phase 1.5 kW Cala Pump	CA200T	1	16.5	0.058
Single phase 2.2 kW Cala Pump	CA300M	1	19.5	0.058
Tri phase 2.2 kW Cala Pump	CA300T	1	19.5	0.058
Single phase 2.9 kW Cala Pump	CA400M	1	22.5	0.058
Tri phase 3.3 kW Cala Pump	CA450T	1	22.5	0.058

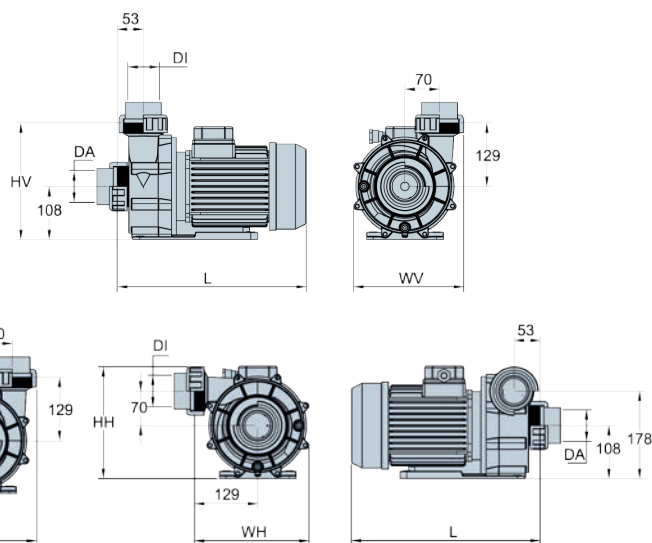

TECHNICAL FEATURES

Code	Power		Size						
	kW	HP	L	WV	HV	WH	HH	DA	DI
CA150M	1.1	1.5	350	225	237	235	228	Ø63	Ø63
CA150T									
CA200M	1.5	2.0	365	225	237	235	228	Ø63	Ø63
CA200T									
CA300M	2.2	3.0	385	225	237	235	228	Ø63	Ø63
CA300T									
CA400M	2.9	4.0	415	225	237	235	228	Ø63	Ø63
CA450T	3.3	4.5							

The sauna pictures do not show the standard product (some accessories can be included from table Accessories Summary). Please note the codes of the accessories when ordering.

- The benefits of an AstralPool sauna range from muscle relaxation to sweat stimulation thanks to their hot and dry environment (relative humidity between 20% and 50%).
- AstralPool saunas are made from prefabricated panels with interior insulation in mineral wool and aluminium.
- The wall coating is covered with pre-treated wood that has been fired and dried to last for many years.

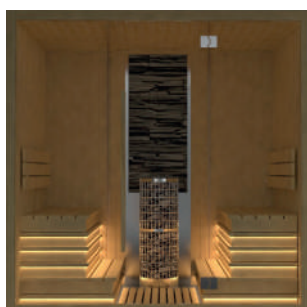

2 seats, code 70470-70471

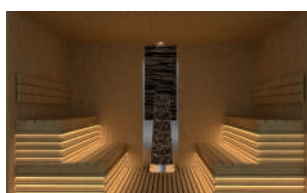

4 seats, code 70439-70442

The Miramonte sauna can be made to order in the following woods: spruce, thermo Aspen, Canadian spruce and red cedar.

Miramonte sauna

ASTRALPOOL

DESCRIPTION

Miramonte sauna reflects the excellence of a Finnish sauna formed of high-quality white pinewood vertical panels and abachi timber flooring. The entire front panel of the Miramonte sauna is glazed to showcase the LED lighting inside. Also includes 2 benches with abachi headrests and a heater adapted to each size.

Dimensions (mm)	Code	Standard Pack	Standard weight in kg	Standard volume in m ³
Spas				
200 x 150 x 210	70470	-	-	-
200 x 200 x 210	70471	-	-	-
250 x 200 x 210	70439	-	-	-
250 x 250 x 210	70440	-	-	-
300 x 250 x 210	70441	-	-	-
300 x 300 x 210	70442	-	-	-
Accessories				
Stainless steel accessories set	70443	un.	-	-
Set of decorative salt elements	70444	un.	-	-
Outside wall finished with vertical timber panels	70447	metre length	-	-
Stone-based decorative wall protection	70456	un.	-	-
Remote control kit for RGB colours	70457	un.	-	-

TECHNICAL FEATURES

Code	Type	Dimensions (cm)	Heating (kW)	Control unit
70470	Miramonte sauna	200 x 150 x 210	7 kW 230/400V 3~	Touchscreen / Exterior
70471	Miramonte sauna	200 x 200 x 210	7 kW 230/400V 3~	Touchscreen / Exterior
70439	Miramonte sauna	250 x 200 x 210	9 kW 230/400V 3~	Touchscreen / Exterior
70440	Miramonte sauna	250 x 250 x 210	9 kW 230/400V 3~	Touchscreen / Exterior
70441	Miramonte sauna	300 x 250 x 210	10.8 kW 230/400V 3~	Touchscreen / Exterior
70442	Miramonte sauna	300 x 300 x 210	13.5 kW 230/400V 3~	Touchscreen / Exterior

Classic Select sauna



The Classic sauna can be made to order in the following woods: white pine, thermo Aspen, Canadian spruce and red cedar.

Optional: glass panel follow-on from door.

DESCRIPTION

The Classic sauna is designed with vertical panels and spruce wood flooring. It has a timber-framed glass door, two seats with a backrest against the wall and an abachi headrest. Includes: Wooden accessories kit, ergonomic seating, rounded backrest, heater with premium protection.

Dimensions (mm)	Code	Standard Pack	Standard weight in kg	Standard volume in m ³
Spas				
150 x 150 x 210	70431	-	-	-
200 x 150 x 210	70432	-	-	-
200 x 200 x 210	70433	-	-	-
250 x 200 x 210	70455	-	-	-
250 x 250 x 210	70434	-	-	-
300 x 250 x 210	70436	-	-	-
300 x 300 x 210	70437	-	-	-
400 x 300 x 210	70438	-	-	-
Accessories				
Stainless steel accessories set	70443	un.	-	-
Set of decorative salt elements	70444	un.	-	-
Remote control kit for RGB LED colours	70445	un.	-	-
Touchscreen control unit for sauna heater	70446	un.	-	-
Outside wall finished with vertical timber panels	70447	metre length	-	-
Roof extension	70448	m ²	-	-
Tinted/transparent glass window	70449	m ²	-	-
Concealed heater for sauna up to 300 x 250 cm	70450	un.	-	-
Concealed heater for sauna more than 300 x 250 cm	70451	un.	-	-
Extra wall for concealed heater	70452	metre length	-	-
Aroma dosing system	70453	un.	-	-

TECHNICAL FEATURES

Code	Type	Dimensions (cm)	Heating (kW)	Control unit
70431	Classic sauna	150 x 150 x 210	4.5kW 230/400 3~	Exterior
70432	Classic sauna	200 x 150 x 210	6kW 230/400 3~	Exterior
70433	Classic sauna	200 x 200 x 210	6kW 230/400 3~	Exterior
70455	Classic sauna	250 x 200 x 210	8kW 230/400 3~	Exterior
70434	Classic sauna	250 x 250 x 210	9kW 230/400 3~	Exterior
70436	Classic sauna	300 x 250 x 210	10.5kW 230/400 3~	Exterior
70437	Classic sauna	300 x 300 x 210	13.5kW 230/400 3~	Exterior
70438	Classic sauna	400 x 300 x 210	16.5kW 230/400 3~	Exterior

St. Moritz sauna

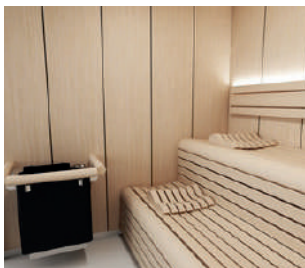

The St. Moritz sauna can be made to order in the following woods:

- Standard wood: Hemlock Playwood
- Bench wood: Abichi

DESCRIPTION

- Hemlock playwood panels 14 mm.
- Console benches and backrest of Abichi 21 mm.
- Secured transparent glass 8 mm.
- Wall mounted Harvia sauna heater.
- Outdoor touch control panel.
- Led light Warm White 3000 K.

Dimensions (mm)	Code	Standard Pack	Standard weight in kg	Standard volume in m ³
Spas				
180 x 180 x 210	72908	-	-	-
220 x 220 x 210	72909	-	-	-
260 x 220 x 210	72910	-	-	-
300 x 250 x 210	72911	-	-	-
Accessories				
Stainless steel accessories set	70443	un.	-	-
RGB Led lighting kit with remote control	70445	un.	-	-
Salt decorative elements set	70444	lin.m	-	-
Hidden heater	70450	un.	-	-
Additional Wall for hidden heater	70452	lin.m	-	-

TECHNICAL FEATURES

Code	Dimensions (cm)	Light	Control Unit	Heater
72908	180 x 180 x 210	Led White / RGB	Touchscreen Exterior	6 kW 230 / 400 3~
72909	220 x 220 x 210	Led White / RGB	Touchscreen Exterior	8 kW 230 / 400 3~
72910	260 x 220 x 210	Led White / RGB	Touchscreen Exterior	9 kW 230 / 400 3~
72911	300 x 250 x 210	Led White / RGB	Touchscreen Exterior	10.5 kW 230 / 400 3~

Innsbruck sauna

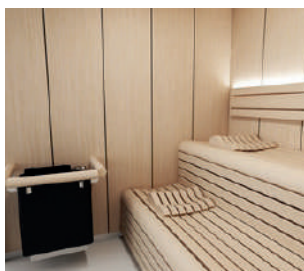

DESCRIPTION

- Hemlock playwood panels 14 mm.
- Ergonomic benches and backrest of Abichi 21 mm.
- Secured transparent glass 8 mm.
- Wall mounted Harvia sauna heater.
- Outdoor touch control panel.
- Led light Warm White 3000 K.
- Ceiling led light with optional chromotherapy.

Dimensions (mm)	Code	Standard Pack	Standard weight in kg	Standard volume in m ³
Spas				
135 x 135 x 210	72901	-	-	-
180 x 180 x 210	72902	-	-	-
220 x 220 x 210	72903	-	-	-
260 x 220 x 210	72904	-	-	-
300 x 250 x 210	72905	-	-	-
Accessories				
Stainless steel accessories set	70443	un.	-	-
RGB Led lighting kit with remote control	70445	un.	-	-
Outside Wall finished with vertical playwood panels	To consult	lin.m	-	-
Salt decorative elements set	To consult	un.	-	-
Hidden heater	To consult	un.	-	-
Additional Wall for hidden heater	To consult	lin.m	-	-

The Innsbruck sauna can be made to order in the following woods:

- Standard wood: Hemlock Playwood
- Bench wood: Abichi

TECHNICAL FEATURES

Code	Dimensions (cm)	Light	Control Unit	Heater
72901	135 x 135 x 210	Led White / RGB	Touchscreen Exterior	6 kW 230 / 400 3~
72902	180 x 180 x 210	Led White / RGB	Touchscreen Exterior	6 kW 230 / 400 3~
72903	220 x 220 x 210	Led White / RGB	Touchscreen Exterior	8 kW 230 / 400 3~
72904	260 x 220 x 210	Led White / RGB	Touchscreen Exterior	9 kW 230 / 400 3~
72905	300 x 250 x 210	Led White / RGB	Touchscreen Exterior	10.5 kW 230 / 400 3~

Bella sauna

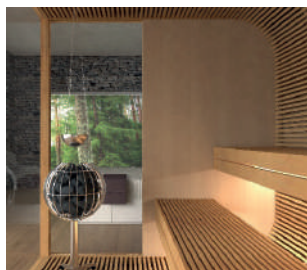

The Bella sauna can be made to order in the following woods:

- Standard wood: Hemlock Playwood
- Bench wood: Thermo Aspen

DESCRIPTION

- Hemlock playwood panels 14 mm.
- Curved decorative elements of Thermo Aspen 21 mm.
- Benches of thermos Aspen 21 mm.
- Secured transparent glass 8 mm.
- Harvia design sauna heater.
- Outdoor touch control panel.
- Aromatherapy/Salt Metal Bowl.
- Led light warm white 3000 K.
- Option for glass ceiling.

Dimensions (mm)	Code	Standard Pack	Standard weight in kg	Standard volume in m ³
Spas				
180 x 180 x 210	72916	-	-	-
230 x 180 x 210	72917	-	-	-
230 x 230 x 210	72918	-	-	-
280 x 230 x 210	72919	-	-	-
Accessories				
Stainless steel accessories set	70443	un.	-	-
RGB Led lighting kit with remote control	70445	un.	-	-
Outside wall finished with vertical playwood panels	To consult	lin.m	-	-
Glass roof panel	To consult	sq.m	-	-
Heater safety railing	To consult	un.	-	-

TECHNICAL FEATURES

Code	Dimensions (cm)	Light	Control Unit	Heater
72916	180 x 180 x 210	Led White / RGB	Touchscreen Exterior	6.9 kW 230 / 400 3~
72917	230 x 180 x 210	Led White / RGB	Touchscreen Exterior	6.9 kW 230 / 400 3~
72918	230 x 230 x 210	Led White / RGB	Touchscreen Exterior	10.5 kW 230 / 400 3~
72919	280 x 230 x 210	Led White / RGB	Touchscreen Exterior	10.5 kW 230 / 400 3~

Lobos sauna

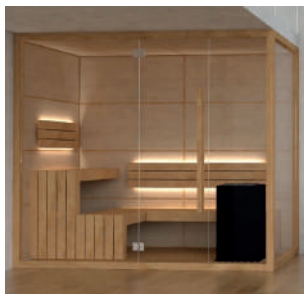

The Lobos sauna can be made to order in the following woods:

- Standard wood: Hemlock Playwood
- Bench wood: Abichi

DESCRIPTION

- Hemlock playwood panels 14 mm.
- Benches of Abachi 21 mm.
- Secured transparent glass 8 mm.
- Exclusive Harvia sauna heater.
- Outdoor touch control panel.
- Led light Warm White 3000 K.

Dimensions (mm)	Code	Standard Pack	Standard weight in kg	Standard volume in m ³
Spas				
134 x 254 x 210	72913	-	-	-
194 x 195 x 210	72914	-	-	-
254 x 254 x 210	72915	-	-	-
Accessories				
Stainless steel accessories set	70443	un.	-	-
Salt decorative elements set	70444	un.	-	-
Remote control kit for RGB LED colours	70445	un.	-	-
Outside wall finished with vertical timber panels	70447	lin.m	-	-
Roof extension	70448	sq.m	-	-
Tintes/transparent glass window	70449	sq.m	-	-

TECHNICAL FEATURES

Code	Dimensions (cm)	Light	Control Unit	Heater
72913	134 x 254 x 210	Led White / RGB	Touchscreen Exterior	6 kW 230 / 400 3~
72914	194 x 195 x 210	Led White / RGB	Touchscreen Exterior	8 kW 230 / 400 3~
72915	254 x 254 x 210	Led White / RGB	Touchscreen Exterior	9 kW 230 / 400 3~

Sauna accessories



70443

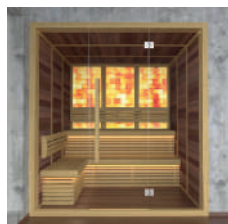

70444



70446



70447

 70450
70451

70453



70456



70457



2nd full glass side

 Heater safety
railing

TECHNICAL FEATURES

Code	Accessory type	Measure	CLASSIC	MIRAMONTE	INNSBRUCK	ST.MORITZ	LOBOS	BELLA
70443	Stainless steel sauna accessories set	un.	optional	optional	optional	optional	optional	optional
70444	Salt decorative elements set	un.	optional	optional	optional	optional	optional	N/A
70445	RGB Led lighting kit with remote control	un.	optional	optional	optional	optional	optional	optional
70446	Touchscreen control unit for sauna heater	un.	optional	Standard	Standard	Standard	Standard	Standard
70447	Outside wall finished with vertical timber panels	lin.m.	optional	optional	optional	optional	optional	optional
70448	Roof extension	sq.m.	optional	optional	optional	optional	optional	optional
70449	Tintes / transparent glass window	sq.m.	optional	optional	optional	optional	optional	optional
70450	Concealed heater for sauna up to 300 x 250 cm	un.	optional	optional	optional	optional	optional	N/A
70451	Concealed heater for sauna more than 300 x 250 cm	un.	optional	optional	optional	optional	optional	N/A
70452	Additional wall for hidden heater	lin.m.	optional	optional	optional	optional	optional	N/A
70453	Aroma dosing system	un.	optional	optional	optional	optional	optional	optional
70456	Decorative wall protection made of stones	un.	optional	optional	optional	optional	optional	N/A
70457	RGB Chromo therapy kit with remote control	un.	optional	optional	optional	optional	optional	N/A
Request	2nd full glass side	sq.m.	N/A	N/A	N/A	N/A	optional	optional
Request	Glass roof panel	sq.m.	optional	optional	optional	optional	optional	optional
Request	Heater safety railing	un.	Standard	optional	Standard	Standard	Standard	optional

Standard: Included with sauna code.

Optional: Additional code.

N/A: Not available.

Harvia Helix steam generators



DESCRIPTION

Includes control panel and temperature sensor.

	Code	Standard Pack	Standard weight in kg	Standard volume in m ³
Steam generator Harvia Helix				
4.5 kW	61400	1	-	-
6 kW	61401	1	-	-
9 kW	61402	1	-	-
11 kW	60327	1	-	-
15 kW	61403	1	-	-

Harvia Helix Pro steam generators

DESCRIPTION

Includes control panel, temperature sensor, automatic discharge valve and fragrance pump.

	Code	Standard Pack	Standard weight in kg	Standard volume in m ³
Steam generator Harvia Helix Pro				
22 kW	61404	1	-	-
30 kW	61405	1	-	-
Auto Clean Valve Harvia	60328	1	-	-

Steam Pack



DESCRIPTION

The new generation of Steam room equipment. Single unit with metal structure. Compact design. Easy and simple installation.

Description	Heating (kW)
Steam pack for room 2-5 m ³	4.5 kW 230/400V 3~
Steam pack for room 3-8 m ³	5.7 kW 230/400V 3~
Steam pack for room 6-12 m ³	9 kW 230/400V 3~
Steam pack for room 10-15 m ³	10.8 kW 230/400V 3~
Steam pack for room 12-20 m ³	15 kW 230/400V 3~
Steam pack for room 20-29 m ³	22 kW 230/400V 3~
Steam pack for room 20-29 m ³	30 kW 230/400V 3~



Harvia Vega sauna heater

DESCRIPTION

Stones included.

	Code	Standard Pack	Standard weight in kg	Standard volume in m ³
Harvia Vega sauna heater				
4.5 kW	61387	1	-	-
4.5 kW E	61388	1	-	-
6 kW	61389	1	-	-
6 kW E	61390	1	-	-
8 kW	60323	1	-	-
8 kW E	60325	1	-	-
9 kW	60324	1	-	-
9 kW E	60326	1	-	-



Xenio Control

DESCRIPTION

Harvia Xenio is a control unit with a touch control panel. Xenio provides a modern and subtly stylish user interface for controlling the heart of the sauna, the heater. The stylishly small yet clear touch control panel is easy to install where you want it: in the sauna, the shower room, the dressing room, or even the living room. The control panel enables you to see with just one look when your sauna is at the right temperature for you.

	Code	Standard Pack	Standard weight in kg	Standard volume in m ³
XENIO 110 max. for 11kW electric heaters				
XENIO 170 for up to 17 kW heaters				





DEHUMIDIFICATION



526 AstralPool - CDP Line 2
Dehumidifier

CDP LINE 2 Dehumidifier



DESCRIPTION

The new CDP LINE 2 dehumidifier console is used in installations where humidity and temperature control of small pools and spas is required.

- Evaporation and condensation battery made out of copper pipes with lacquered aluminium fins (specially designed for corrosive environments).
- New generation of rotative compressors, more efficient, reliable and quieter.
- Electric heating or hot water coil option.

CDP LINE 2 casing is made of polypropylene (EPP) which reduces its weight and noise level. It is also possible to personalize the front panel with a dedicated image, as an optional extra.

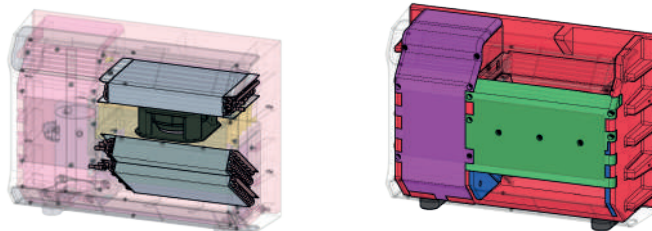

TECHNICAL FEATURES

Model		CDP LINE - 2	CDP LINE - 3	CDP LINE - 4	CDP LINE - 5												
Dehumidifier only		65891	65892	65893	65894												
With hot water coil option		65895	65896	65897	65898												
With electric heating option		65899	65900	65901	65902												
Dehumidification capacity*	l/hour	2	3	4	5												
Heating capacity	Hot water coil option kW	6.0		12.0													
	Electric heating option kW	4.0		5.0													
Voltage	V/Ph/Hz	230 / 1 / 50															
Fan	m³/h	850 (centrifugal fan)			1,000 (centrifugal fan)												
Refrigerant	Type	R-410A															
Noise level 1m	dB (A)	62			65												
Noise level 3m	dB (A)	54.7			60												
Size	mm	A	B	C	D	E	F	G	H	I	J	K	L	M	N	O	P
		400	800	1075	290	67	80	610	30	480	152	120	531	825	325	45	50
Net weight	Hot water coil option (kg)	54		56		63		65									
	Electric heating option (kg)	50		52		58		60									

* General operating conditions: Installation air temperature: 28°C. Humidity: 75 %. Installation minimum air temperature: 20°C.

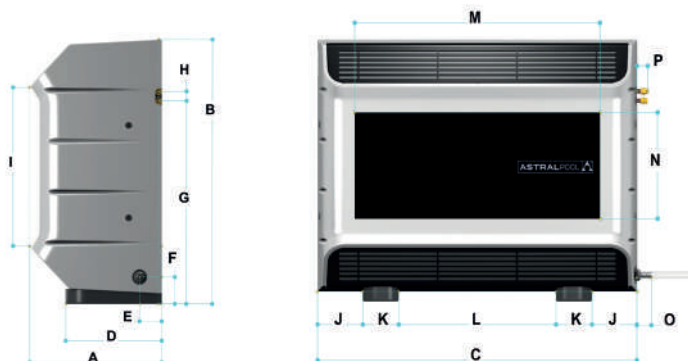





HEATING



530 HEAT PUMPS

- 536 AstralPool Heat 3
- 538 Pro Elyo Touch
- 540 Bering Inverter
- 542 Evoline
- 544 Optima
- 546 Maya

548 CHILLERS SOLUTIONS

- 548 Alaska - Siberia

550 ELECTRIC HEATERS

- 550 Compact ElectricHeat

552 HEAT EXCHANGERS

- 552 Equipped Waterheat
- 553 Waterheat EVO
- 554 Etna

Swimming pool heating solutions

Did you know it ?

- Equipping the pool with an isothermal cover allows to divide the power need by 2 !
As a result, if 12kW is needed to heat a pool without cover, 6kW is enough to heat the same pool with a cover.
- Using the heat pump when the outdoor air is the hottest will allow to maximize the performances (hence minimize the electricity consumption). Heating during hot sunny days and covering at night is the optimal solution!
- Covering the pool at night (or when the outdoor air T°C is fresher) with an isothermal cover, will slow down the decrease of pool T°C.

Parameters for choosing a heating system

To define a system suitable for a pool, many parameters need to be considered. The most important parameters (but non-exhaustive) are the ones below:



1. Average outdoor air temperature (°C)
2. Pool water target temperature (in °C)
3. Period of use
4. Pool volume (m³)
5. Presence of an isothermal cover or not
6. Filtration time

To consider all the parameters which impact the sizing of a heating system, online AstralPool configurators are available:

- For professional use, visit our Profluidra website.
- For public use, visit our simplified configurator on AstralPool website.

The choice of heating equipment also depends on the energy source that will be used.

COMPARATIVE TABLE OF RANGES

	Heat pumps	Electric heaters	Heat exchangers
			
Solution	Stand-alone, dedicated to the pool	Stand-alone, dedicated to the pool	Coupled to the domestic heating
Energy used	Electricity	Electricity	Domestic heating source (gas, oil, electricity, renewable, etc.)
Running cost	€ *	€€€	€ to €€€ **
Investment	€€	€	€
Advantages	Energy efficient Low operating cost	Simple installation	Compatible with all heating systems
Uses	All open air or indoor pools	Spas and pools used at weekends or holiday homes	Indoor and outdoor pools close to the boiler in the house

* A heat pump is a very efficient solution which can reconstitute great more power than it consumes thanks to its thermodynamic system.

** The running cost will depend on the heating source. If renewable (e.g solar energy), it will be very low. However, with a gas, oil or electricity heating source, the running costs will be higher.

Heat pumps

Understand the concept of performance

To compare the performance of different heat pumps, it is essential to compare restituted power and performance coefficient.

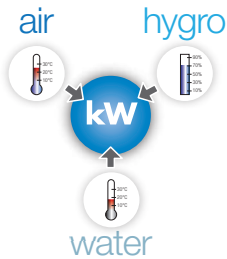

Two main values characterise the performance of heat pumps: their power and their performance coefficient.

- **Power**, expressed in kW, indicates the quantity of heat transferred to the water. It is expressed in specific climatic conditions to which the heat pump is exposed during use:
 - Temperature of the outside air (in °C)
 - Humidity of the outside air (in %)
 - Temperature of the water in the pool (in °C)

For instance (see graphic below), a Proelyo Touch will restitute 9.8kW @0°C air / 26°C water / 70% humidity, 17kW @15°C air / 26°C water / 70% humidity and 25.5kW @28°C air / 28°C water / 80% humidity.

- **The coefficient of performance (COP)** is the ratio between the restituted power and the power consumption of the heat pump. As a result, it is the ratio at specific climatic conditions too.

As an example, a performance coefficient of 5 means that for 1 kWh consumed at the electricity meter, the heat supplies 5 times more energy to the water in the pool, or 5 kWh.

So the higher the performance coefficient, the more efficient the system.

- **Power and COP for Inverter heat pumps:** It will be indicated as a range (e.g 12 - 3). Indeed, as the purpose of an Inverter heat pump is to adjust its power (=compressor speed) to optimise the efficiency, the power and COP are given at the maximum-minimum speed of the compressor.

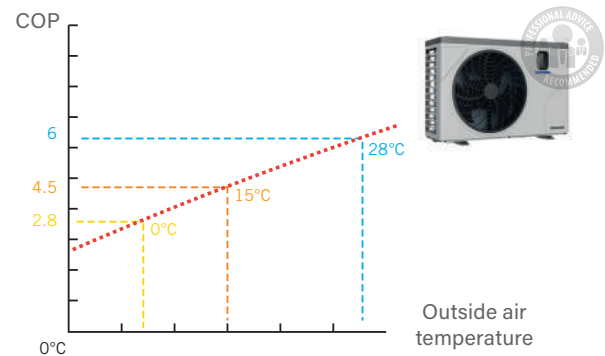
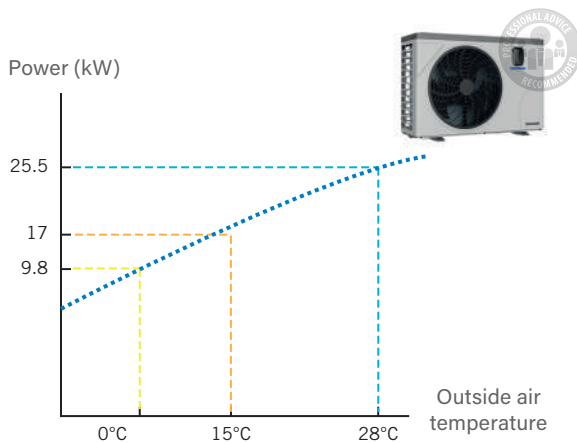

Advices for a successful installation

A heat pump system includes 'moving' parts (compressor, fan, etc.), vibrations from which can spread and build up.

To avoid or reduce disturbances, a few installation rules should be followed:

- Favour open spaces (avoid corners or interior courtyards), because sound waves coming from all sides of the system are reflected by the surfaces facing them.
- Do not install the system below or facing a window.
- Relative to neighbouring properties:
 - Install the system as far as possible from property boundaries.
 - The fan should not point towards neighbouring properties.

Understanding the main features of heat pumps

Full Inverter technology

Inverter technology enables a heat pump to change its power mode depending on the temperature of the pool water and the weather conditions.

It therefore runs to achieve the best energy efficiency at the lowest noise level.

3 operating modes:

1. Silent: Ideal to maintain the temperature or at night time

- Heat Pump runs at low power setting
- Compressor operates on low speed ranges to minimize energy consumption
- Lowest noise and highest COP

2. Smart: Automatic power adjustment to maximize comfort and efficiency

- Compressor operates smartly from low to high speed ranges
- Reduced noise and energy consumption

3. Powerful: Ideal to begin the season or to operate in cold conditions

- Heat Pump runs at high power setting
- Compressor operates on high speed ranges to heat the pool faster
- Maximum heating power

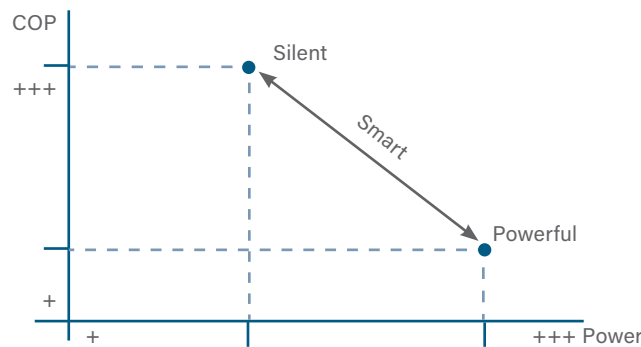

Vertical vs Horizontal blowing

Vertical blowing has 2 main advantages:

- It is typically suitable for small spaces as a reduced free area is required around the unit.
- With a same sound level between a horizontal and vertical heat pump, the perceived sound level will be lower for vertical heat pumps because the air is blown upwards.

Active or Passive defrosting





When the outside temperature is low, the evaporator will tend to ice up, which reduces its efficiency: this ice must therefore be removed. There are 2 types of defrosting:

- **Passive defrosting: By ventilation for a seasonal use (Minimum outside air temperature >+5°C)**
The heat pump will stand by for a few minutes. Only the fan operates, forcing outside air to defrost naturally. This type of defrosting is only efficient when the outside air temperature is above +5°C, for a seasonal use only.
- **Active defrosting: By cycle inversion - for extended or full season (Minimum outside air temperature <5°C)**
The refrigerating circuit is reversed, calories from the pool water are used to defrost the evaporator. This type of defrosting allows an extended use as it is able to defrost when the outside temperature is below +5°C.

Choosing a heat pump with an automatic cooling mode

It is not recommended to maintain the temperature of the water in the pool at a higher temperature than +30°C to prevent water quality from deteriorating, turning green and damaging the liner. In hot areas, during hot seasons or if the pool is equipped with a shelter, it is common that the pool water temperature can exceed +30°C.

A heat pump with an automatic cooling mode will stabilize the pool water temperature at the desired target, below 30°C.

COMPARATIVE TABLE OF HEAT PUMPS				
	Evoline	Bering Inverter	Proelyo Touch	APH3
				
KEY DRIVERS FOR A FAST PRE-SELECTION				
Maximum pool size (m ³)*	185	110	205	150
Min Air T°C	+0°C	-7°C	-20°C	-20°C
Seasonality	Extended season	Extended season	All year round	All year round
Technology	ON-OFF	INVERTER	FULL INVERTER	FULL INVERTER
Cooling mode	✓	✓	✓	✓
App control (WiFi)	×	×	×	×
Air blowing type	++ Horizontal	++ Horizontal	++ Horizontal	+++ Vertical
Free area around the heat pump	++	++	++	+++
Electric power supply	Single-phase and three phase	Single-phase	Single-phase and three phase	Single-phase
Can be installed indoor	×	×	×	×
PERFORMANCES				
Range of powers (@28°C Air / 28°C Water)	4.7kW to 30.9kW (10 powers)	7kW to 19kW (6 powers)	8.5kW to 35kW (10 powers)	14kW to 26kW (4 powers)
Range of powers (@15°C Air / 26°C Water)	3.2kW to 22.8kW (10 powers)	4.7kW to 13.5kW (6 powers)	6kW to 25kW (10 powers)	9.6kW to 18.5kW (4 powers)
Noise level	+	++	+++	+++
Compressor type	++ ON/OFF	+++ Inverter	+++ Inverter	+++ Inverter
Fan type	+ ON/OFF	+ ON/OFF	+++ Inverter	+++ Inverter
Gas type	R32/R410A	R32	R32/R410A	R32
MODES				
Number of modes	1	3 (Automatic or manual)	3 (Automatic or manual)	3 (Automatic or manual)
Silence mode	×	✓ (Automatic if Smart mode or manual, compressor only)	✓ (Automatic if Smart mode or manual, Fan + Compressor)	✓ (Automatic if Smart mode or manual, Fan + Compressor)
Smart mode	✓	✓	✓	✓
Boost/Standard mode	✓	✓ (Automatic if Smart mode or manual)	✓ (Automatic if Smart mode or manual)	✓ (Automatic if Smart mode or manual)
TECHNICAL FEATURES				
Defrosting type	+++ Cycle inversion	+++ Cycle inversion	+++ Cycle inversion	+++ Cycle inversion
Casing	ABS	Galvanized steel	ABS	ABS
OTA (over-the-air firmware update)	×	×	×	×
EASE OF USE				
Heating priority (filtration control)	✓	✓	✓	✓
Remote HMI	✓	✓	✓	✓
HMI type	LCD LED	LCD	LCD LED	LCD

*For a pool with cover, depth 1.5m, zone 7, 14h filtration time, from May to September.

COMPARATIVE TABLE OF HEAT PUMPS

	Evoline	Bering Inverter	Proelyo Touch	APH3
				

PERFORMANCES COMPARISON AT CLOSE POWERS (@15°C AIR / 26°C WATER)

Power in kW @28°C	14,9 kW	14 kW	15,9 kW	14 kW
COP @28°C	6.3	5.6-8.5**	6-16**	6.7-13**
Power in kW @15°C	10,7 kW	9,5 kW	11 kW	9.6 kW
COP @15°C	4.9	4-5.8**	4.5-8**	5.1-8.5**
Acoustic pressure (dB) @1m	56	47-56**	40-54**	40-54**

WARRANTY

Heat Pump	2 years	2 years	2 years	2 years
Condenser	7 years	7 years	7 years	7 years

INCLUDED ACCESSORIES

	• 1 x Winter Cover.	• 1 x Winter Cover.	• 1 x Winter Cover.	• 1 x Winter Cover.
	• Condensate drain kit	• Condensate drain kit	• Condensate drain kit	• Condensate drain kit
	• PVC and gaskets, 1/2 unions, Ø 38 (1"1/2)	• PVC and gaskets, 1/2 unions, Ø 50	• PVC and gaskets, 1/2 unions, Ø 50	• PVC and gaskets, 1/2 unions, Ø 50
	• Anti-vibration feet	• Anti-vibration feet	• Anti-vibration feet	• Anti-vibration feet
	• Remote control kit (including 10m extension cable).	• Remote control kit (including 10m extension cable).		• Remote control kit (including 10m extension cable).
			• 1 x 10m Modbus Signal wire (to connect the Heat Pump to the Connect Box).	• 1 x 10m Modbus Signal wire (to connect the Heat Pump to the Connect Box).

OPTIONAL ACCESSORIES

			• 1 x remote display kit (new display + 10m wire).	
--	--	--	--	--

** @max-min speed.

CLIMATE ZONES

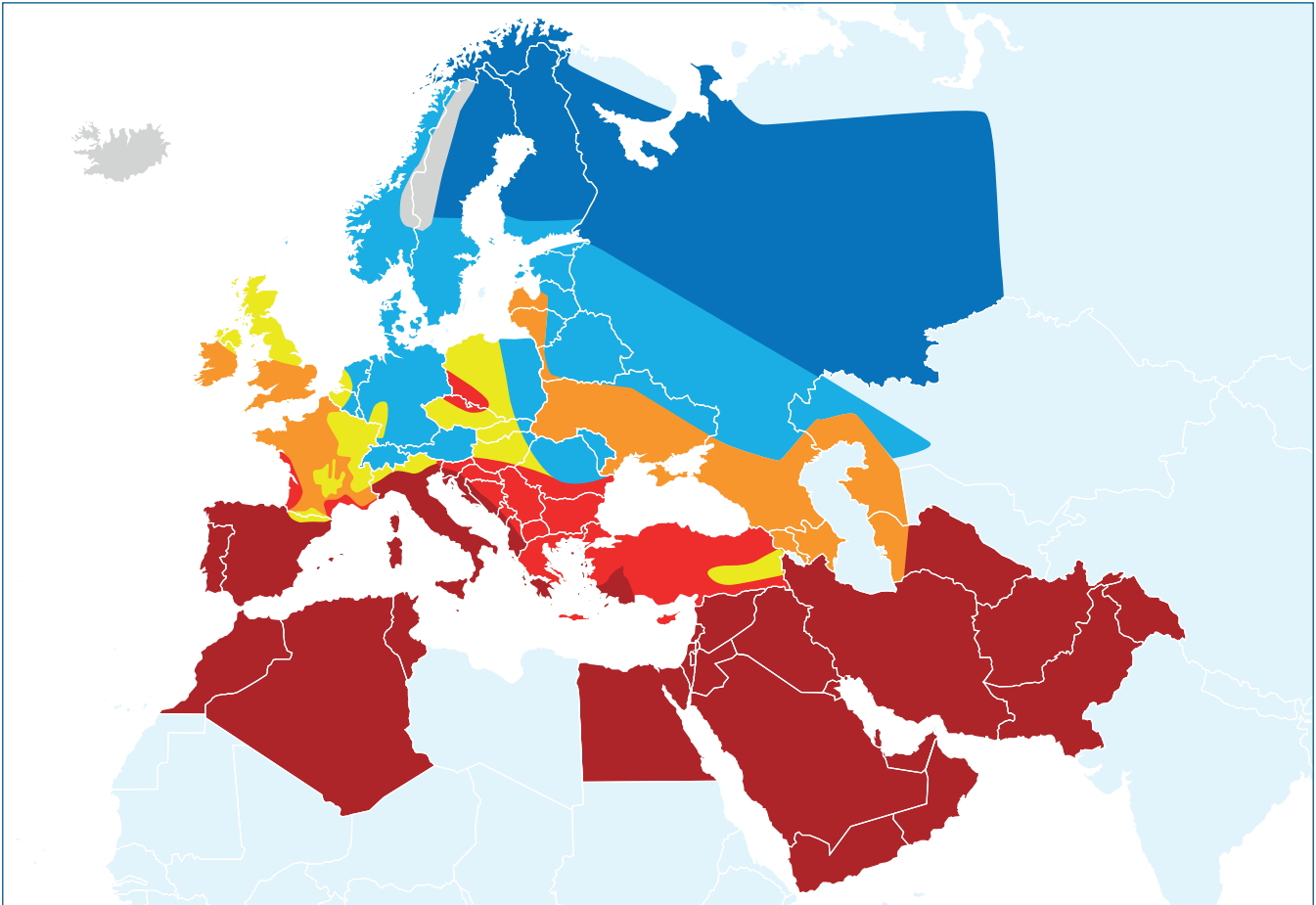

SOUTH AFRICA

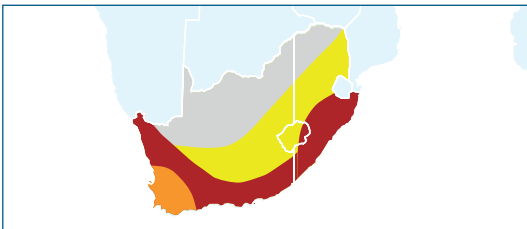

AUSTRALIA

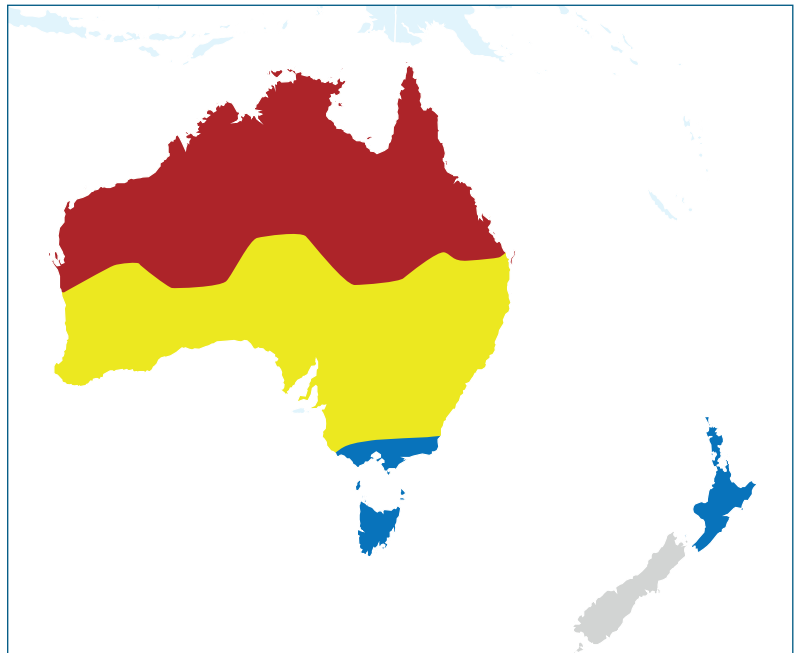

Pool location zones

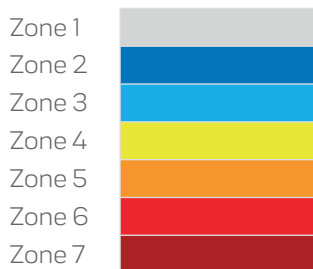

Caribbean Islands, Reunion Island, Canary Islands are part of Zone 7.

AstralPool Heat 3



Fluidra Connect compatible

<150M³

- + Full inverter technology: silent and energy saving.
- + Vertical air blowing for increased comfort.
- + - 20°C lowest outdoor air working temperature.

DESCRIPTION

- Detachable display.
- Digital touchscreen.
- Heating priority mode (filtration pump control).
- ABS plastic housing.
- DC, variable speed fan.
- Automatic cooling mode.
- Titanium water exchanger condenser.
- Inverter Rotary compressor.

ACCESSORIES INCLUDED IN THE PACK

- 1 x Winter Cover.
- 4 x Anti-vibration feet.
- Condensate drainage kit.
- 1 x remote display kit (including 10m extension cable).
- 1 x 10m Modbus Signal wire (to connect the Heat Pump to the Connect Box).
- 2 x PVC fittings ½ union Ø 50.

TECHNICAL FEATURES

Model		APH3-14	APH3-17	APH3-21	APH3-26
Reference		68837	68838	68839	68840
Refrigerant fluid		R32			
Refrigerant fluid quantity	Kg	1.4	1.8		2.6
Recommended water flow	m ³ /h	4	5	6	8
Hydraulic connection	mm	Ø50			
Electric power supply	V/Ph/Hz	220*240V/ 50Hz or 60Hz/ 1PH			
Nominal operating power	A	8.1	9.8	12	16
Maximum operating power	A	11.5	14	17	22.5
Recommended power cable section ⁽¹⁾	mm ²	3 x 2.5		3 x 4	
Acoustic pressure (lp) at 1m (@max-min speed)	dB (A)	40 - 54	41 - 56		42 - 60

HEATING PERFORMANCE

Model		APH3-14	APH3-17	APH3-21	APH3-26
AIR 28°C / WATER 28°C / HUMID. 80%					
Heating capacity (@max-min speed)	(kW)	14 - 3	17 - 3.6	21 - 4.6	26 - 6
Power consumption (@max-min speed)	(kW)	2.1 - 0.2	2.5 - 0.3	3.1 - 0.4	3.9 - 0.5
COP (@max-min speed)		6.7 - 13			
AIR 15°C / WATER 26°C / HUMID. 70%					
Heating capacity (@max-min speed)	(kW)	9.6 - 2.1	11.5 - 2.5	14.3 - 3.2	18.5 - 4.2
Power consumption (@max-min speed)	(kW)	1.9 - 0.2	2.3 - 0.3	2.9 - 0.4	3.6 - 0.5
COP (@max-min speed)		5.1 - 8.5			

(1) For a maximum length of 20 meters.

WEIGHT AND DIMENSIONS

Model		APH3-14	APH3-17	APH3-21	APH3-26
Weight	kg	70	75	92	111
A	mm		820		950
B	mm		830		1025
C	mm		695		900
D	mm		130		130
E	mm		470		660

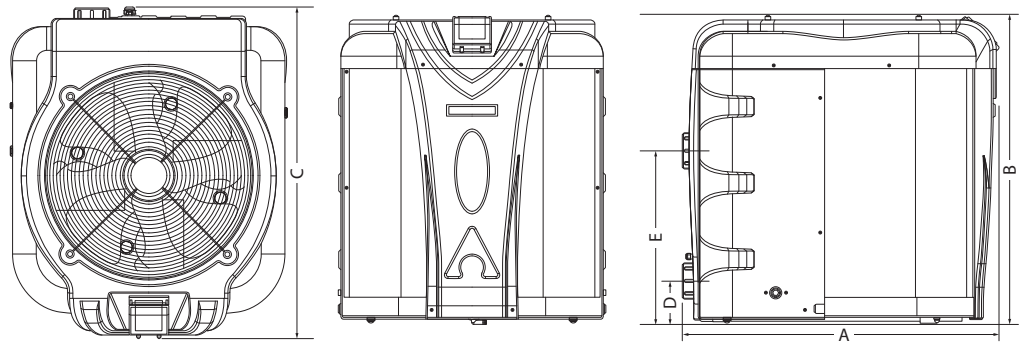

For complete technical & dimensional details, refer to the datasheet/user manual.

HEAT PUMPS SELECTION GUIDE

Parameters of the quick selection guide

This quick selection guide has been configured with the following parameters: private pool, for a use from beginning of may to end of september, average depth 1.5m, 14h filtration time, target pool water temperature 28°C.

Select the power in less than 1 minute

How to read: For a 35m³ pool, with cover, located in zone 4, an APH3-14 is needed*.

*To find the corresponding pool location zone, consult our climate map in page 535.

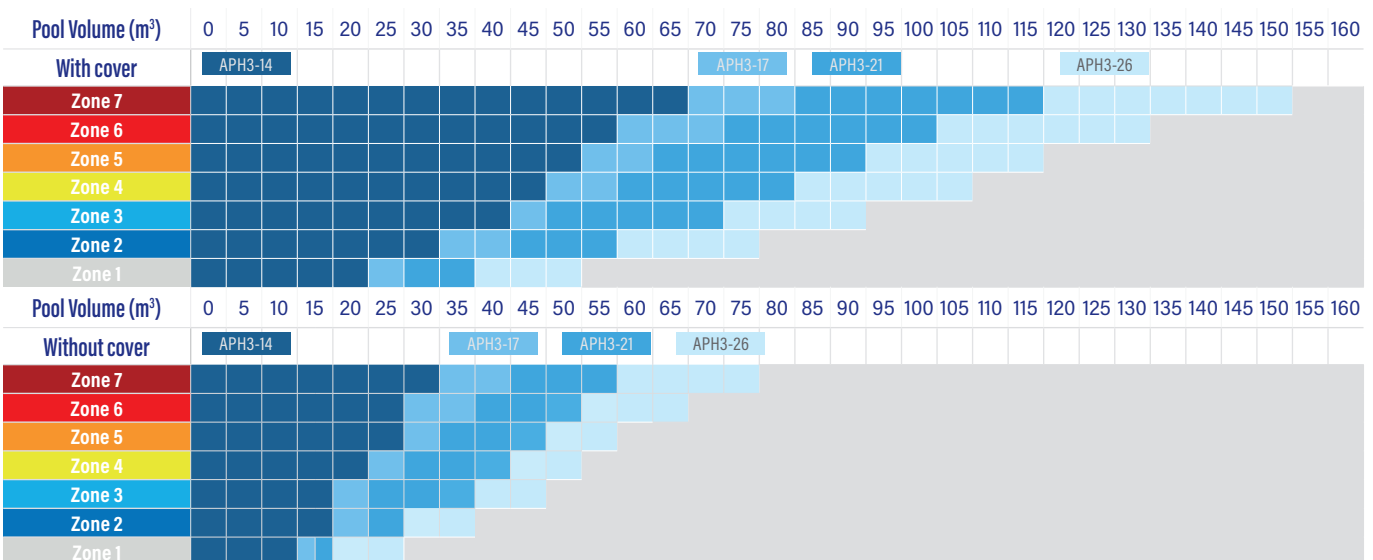

AstralPool recommends to use the web configurators to get a more accurate sizing

For professional use, visit our configurator on Profluidra website.
For public use, visit our simplified configurator on AstralPool website.

Pro Elyo Touch



- + Full inverter technology: silent and energy saving.
- + 8 power levels from 8.5 kW to 35 kW*.
- + - 20°C lowest outdoor air working temperature.

*Temperature conditions of 28°C Air / 28°C Water

DESCRIPTION

- New, wide LED touchscreen.
- Heating priority mode (filtration pump control).
- ABS plastic housing with new injected fan grid; galvanized steel protection grid around the evaporator.
- DC, variable speed fan.
- Automatic cooling mode.
- Automatic defrosting.
- Titanium water exchanger.
- Inverter Rotary compressor.



<205M³

ACCESSORIES INCLUDED IN THE PACK

- 1 x Winter Cover.
- 4 x Anti-vibration feet.
- Condensate drainage kit.
- 1 x 10m Modbus Signal wire (to connect the heat pump to the Connect Box).
- 2 x PVC fittings ½ union Ø 50.

OPTIONAL ACCESSORIES

- Remote display kit. Code: 74199.

TECHNICAL FEATURES

Model		PET-08	PET-10	PET-13	PET-15	PET-19	PET-25	PET-30	PET-35	PET-30T	PET-35T
Reference		74166	74167	74168	74169	74170	74171	74172	74173	74174	74175
Refrigerant fluid		R32								R410A	
Refrigerant fluid quantity	Kg	0.65	0.7	1	1.1	1.5	1.9	2	2.6	3.8	4
Recommended water flow	m ³ /h	4	5	6	7	8	10	13			
Hydraulic connection	mm	PVC 1/2 union Ø50									
Electric power supply	V/Ph/Hz	220*240V/ 50Hz or 60Hz/ 1PH								380V/ 50Hz or 60Hz/ 3PH	
Nominal operating power	A	4.6	5.9	7.2	9.2	10.5	13.2	17.0	22.9	7	8.4
Maximum operating power	A	6.4	8.3	10.0	13.0	14.7	18.5	24.0	32.0	9.8	11.8
Recommended power cable section ⁽¹⁾	mm ²	3x1.5		3x2.5			3x4		3x6	5x2.5	5x4
Acoustic pressure (Lp) at 1m (@max-min speed)	dB (A)	38-51	39-52	40-52	40-54	40-54	41-56	42-60	42-60	42-60	42-60
Number of fans	Units	1						2			

HEATING PERFORMANCE

Model		PET-08	PET-10	PET-13	PET-15	PET-19	PET-25	PET-30	PET-35	PET-30T	PET-35T
AIR 28°C / WATER 28°C / HUMID. 80%											
Heating capacity (@max-min speed)	(kW)	8.50 - 1.9	10.5 - 2.3	13.5 - 3	15.9 - 3	19.8 - 3.8	25.5 - 4.7	30.0 - 6	35 - 8	30.0 - 6	35 - 8
Power consumption (@max-min speed)	(kW)	1.5 - 0.2	1.7 - 0.15	2.2 - 0.2	2.6 - 0.2	3.3 - 0.25	4.2 - 0.3	5 - 0.35	5.9 - 0.5	5 - 0.35	5.9 - 0.5
COP (@max-min speed)		5.8 - 15	6.2 - 16			6 - 16					
AIR 15°C / WATER 26°C / HUMID. 70%											
Heating capacity (@max-min speed)	(kW)	6.0 - 2.5	7.5 - 2	9.0 - 2	11.0 - 2.5	13 - 3	17 - 4	21.0 - 5.5	25.0 - 5.5	21.0 - 5.5	25.0 - 5.5
Power consumption (@max-min speed)	(kW)	1.4 - 0.3	1.75 - 0.25	2.0 - 0.25	2.5 - 0.3	2.9 - 0.4	3.9 - 0.5	4.6 - 0.7	5.4 - 0.7	4.6 - 0.7	5.4 - 0.7
COP (@max-min speed)		4.5 - 8									

(1) For a maximum length of 20 meters.

WEIGHT AND DIMENSIONS

Model		PET-08	PET-10	PET-13	PET-15	PET-19	PET-25	PET-30	PET-35	PET-30T	PET-35T
Weight	kg	56	68	73	78	98	117	128	130	128	130
A	mm	1008		1050			1050			1050	
B	mm	577		709			870			1285	
C	mm	380		440			450			460	
D	mm	111.5		101			111.5			111.5	
E	mm	411.5		491			711.5			911.5	

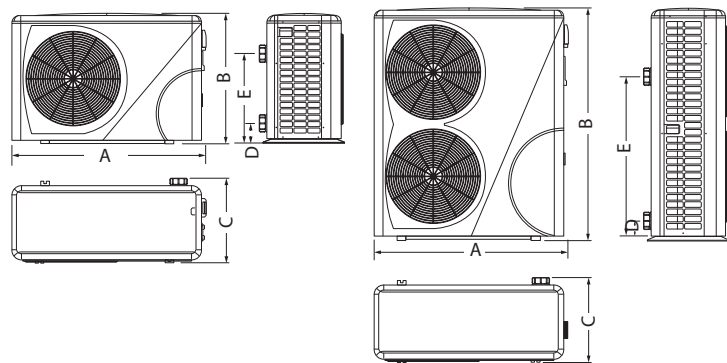

For complete technical & dimensional details, refer to the datasheet/user manual.

HEAT PUMPS SELECTION GUIDE

Parameters of the quick selection guide

This quick selection guide has been configured with the following parameters: private pool, for a use from beginning of may to end of september, average depth 1.5m, 14h filtration time, target pool water temperature 28°C.

Select my heat pump in less than 1 minute

For a 35m³ pool, with cover, located in zone 4, a PET-10 is needed*.

*To find the corresponding pool location zone, consult our climate map in page 535.

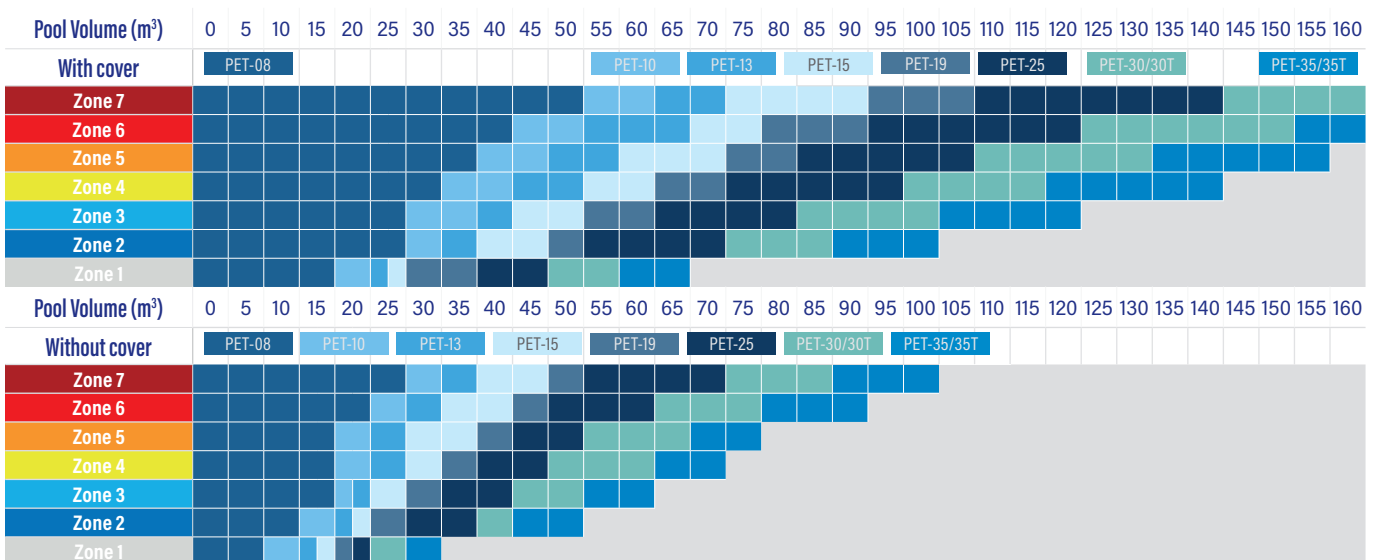

AstralPool recommends to use the web configurators to get a more accurate sizing (change pool shape, pool depth, target pool water temperature, period of use...).

For professional use, visit our configurator on Profluidra website.
For public use, visit our simplified configurator on AstralPool website.

Bering Inverter



- + Inverter technology: silent and energy saving.
- + Heating and Cooling regulation.
- + -7°C lowest outdoor air working temperature.

DESCRIPTION

- Detachable display.
- LCD display
- Heating priority mode (filtration pump control).
- Galvanized steel housing.
- AC, variable speed fan.
- Automatic cooling mode.
- Automatic defrosting.
- Titanium water exchanger.
- Inverter Rotary compressor.especially for corrosive environments.
- Control of purifying system.
- Automatic electrical protections.



<110M³

ACCESSORIES INCLUDED IN THE PACK

- 1 x Winter Cover.
- 4 x Anti-vibration feet.
- Condensate drainage kit.
- 1 x remote display kit (including 10m extension cable).
- 2 x PVC fittings Ø 50.

TECHNICAL FEATURES

Model		Bering Inverter 7kW	Bering Inverter 9kW	Bering Inverter 11kW	Bering Inverter 14kW	Bering Inverter 16kW	Bering Inverter 20kW
Reference		BEXP07i	BEXP09i	BEXP11i	BEXP14i	BEXP16i	BEXP20i
Refrigerant fluid		R32					
Refrigerant fluid quantity	Kg	0.5	0.65	0.75	0.95	1.1	1.5
Recommended water flow	m ³ /h	2.5	2.8	3.7	4	4.6	5.6
Hydraulic connection	mm	Ø50					
Electric power supply	V/Ph/Hz	220*240V / 50Hz or 60Hz / 1PH					
Nominal operating power	A	5.9	7.2	8.7	11	12.4	15
Maximum operating power	A	8.5	10	12.5	15.5	17	21
Recommended power cable section ⁽¹⁾	mm ²	3 x 2.5				3 x 4	
Acoustic pressure (Lp) at 1m (@max-min speed)	dB (A)	45 - 52		46 - 54	47 - 56		49 - 58

HEATING PERFORMANCE

Model		Bering Inverter 7kW	Bering Inverter 9kW	Bering Inverter 11kW	Bering Inverter 14kW	Bering Inverter 16kW	Bering Inverter 20kW
AIR 28°C / WATER 28°C / HUMIDITY 80%							
Heating capacity	(kW)	7 - 3.3	9 - 3.5	11 - 4.8	14 - 5	16 - 5.3	19 - 5.7
Power consumption	(kW)	1.32 - 0.43	1.61 - 0.43	1.96 - 0.6	2.5 - 0.63	2.85 - 0.66	3.39 - 0.67
CDP		8.0 - 5.3		8.5 - 5.6			
AIR 15°C / WATER 26°C / HUMIDITY 70%							
Heating capacity	(kW)	4.7 - 2.4	6.3 - 2.5	7.8 - 3.4	9.5 - 3.5	11.2 - 3.6	13.5 - 3.9
Power consumption	(kW)	1.18 - 0.41	1.56 - 0.42	1.94 - 0.57	2.38 - 0.59	2.8 - 0.62	3.36 - 0.66
CDP		5.6 - 4		5.8 - 4			

(1) For a maximum length of 20 meters.

STANDARD AND CHILLER MODELS - WEIGHT AND DIMENSIONS

Model		Bering Inverter 7kW	Bering Inverter 9kW	Bering Inverter 11kW	Bering Inverter 14kW	Bering Inverter 16kW	Bering Inverter 20kW
Weight	kg	54	56	68	73	78	98

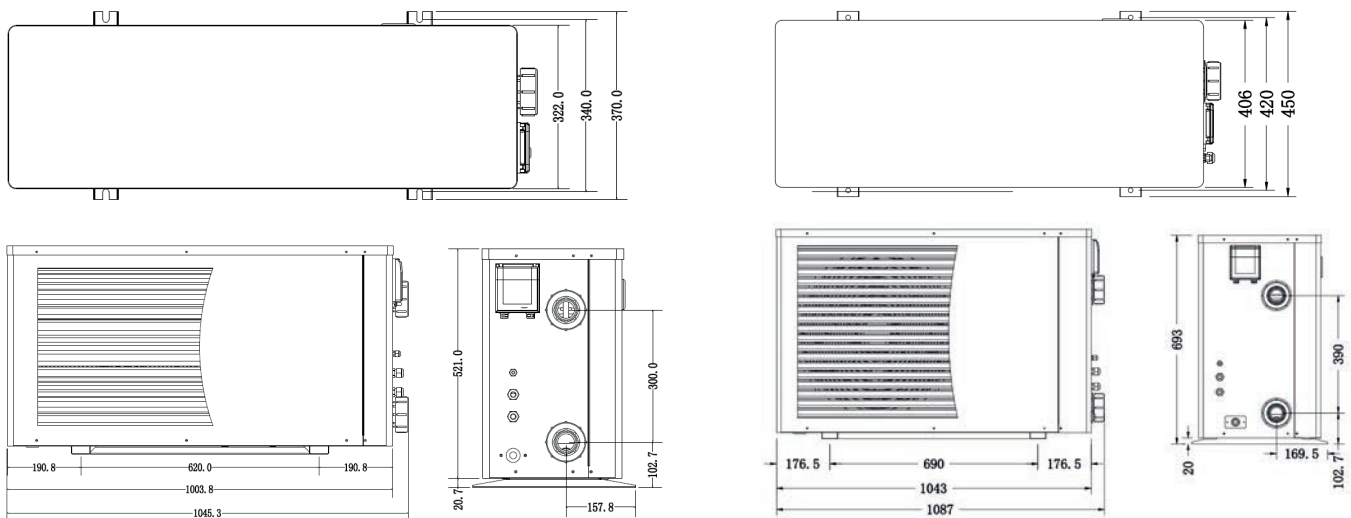

For complete technical & dimensional details, refer to the datasheet/user manual.

HEAT PUMPS SELECTION GUIDE

Parameters of the quick selection guide

This quick selection guide has been configured with the following parameters: private pool, for a use from beginning of may to end of september, average depth 1.5m, 14h filtration time, target pool water temperature 28°C.

Select my heat pump in less than 1 minute

For a 35m³ pool, with cover, located in zone 4, an BEXP09i is needed*.

*To find the corresponding pool location zone, consult our climate map in page 535.

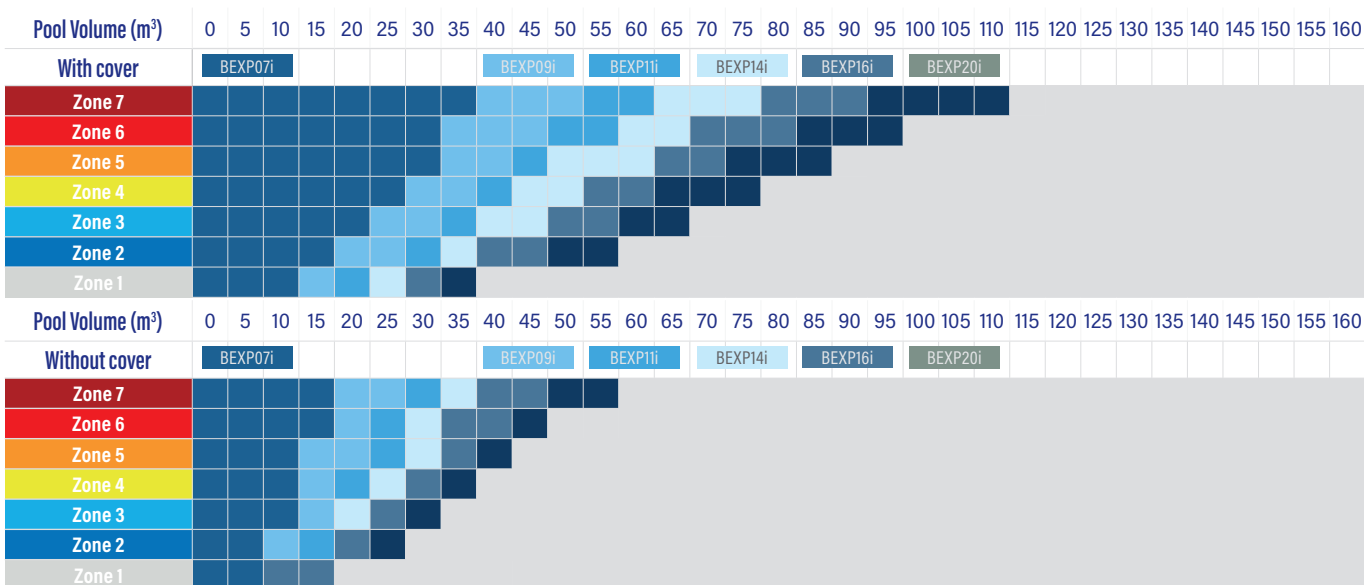

AstralPool recommends to use the web configurators to get a more accurate sizing (change pool shape, pool depth, target pool water temperature, period of use...).

For professional use, visit our configurator on Profluidra website.
For public use, visit our simplified configurator on AstralPool website.

Evoline



- + 8 power levels from 4.7 kW to 30.9 kW*.**
- + Smooth and quiet performance down to 0°C outdoor air temperature.**
- + Automatic Heating and Cooling regulation.**

*Temperature conditions of 28°C Air / 28°C Water

DESCRIPTION

- LCD (LED) display, detachable.
- Heating priority mode (filtration pump control).
- ABS plastic housing.
- AC fan.
- Automatic cooling mode.
- Automatic defrosting.
- Titanium water exchanger.
- Scroll compressor.



<185M³

ACCESSORIES INCLUDED IN THE PACK

- 1 x Winter Cover.
- 4 x Anti-vibration feet.
- Condensate drainage kit.
- 1 x remote display kit (including 10m extension cable).
- 2 x PVC fittings Ø 38 (1¹/₂).

TECHNICAL FEATURES

Model		Evoline 6	Evoline 10	Evoline 13	Evoline 15	Evoline 17	Evoline 20	Evoline 25	Evoline 20T	Evoline 25T	Evoline 35T
Reference		66069-R32	66070-R32	66071-R32	66072-R32	67405-R32	66073M-R32	66074M-MOD	66073-R32	66074-R32	66075-R32
Refrigerant fluid		R32						R410A	R32		
Refrigerant fluid quantity	Kg	0.4	0.75	0.9	1.1	1.15	1.1	2.3	1.1	1.45	2.2
Recommended water flow	m ³ /h	2.5	4.5	6	7.5	9	11	13	11	13	19
Hydraulic connection	mm	ø38 (1 ¹ / ₂)									
Electric power supply	V/Ph/Hz	220*240V / 50 / 1PH						380V / 50Hz or 60Hz / 3PH			
Nominal operating power	A	4.1	6.2	8.9	9.7	11	13.5	16.8	5.1	5.6	10.1
Maximum operating power	A	5.3	8	11.6	12.6	14.2	20.3	25.2	6.7	7.3	13.6
Recommended power cable section ⁽¹⁾	mm ²	3x1.5	3x2.5			3x4		5x2.5		5x4	
Acoustic pressure (Lp) at 1m	dB (A)	<55	<52		<56	<51	<59	<56	<59	<60	
Number of fans	Units	1									2

HEATING PERFORMANCE

Model		Evoline 6	Evoline 10	Evoline 13	Evoline 15	Evoline 17	Evoline 20	Evoline 25	Evoline 20T	Evoline 25T	Evoline 35T
AIR 28°C / WATER 28°C / HUMID. 80%											
Heating capacity	(kW)	4.7	7.4	10.4	11.6	14.9	17.4	22.7	18.5	22.3	30.9
Power consumption	(kW)	0.9	1.3	1.9	2.1	2.4	2.9	3.6	3.0	3.2	4.9
COP		5.4	5.6	5.4	5.6	6.3	5.9	6.4	6.3	6.9	6.4
AIR 15°C / WATER 26°C / HUMID. 70%											
Heating capacity	(kW)	3.2	5.5	7.6	8.4	10.7	12.9	16.3	13.4	16.1	22.8
Power consumption	(kW)	0.8	1.2	1.7	1.9	2.2	2.8	3.5	2.9	3.2	4.8
COP		4.0	4.7	4.5		4.9	4.6	4.7		5.0	4.8

(1) For a maximum length of 20 meters.

WEIGHT AND DIMENSIONS

Model		Evoline 6	Evoline 10	Evoline 13	Evoline 15	Evoline 17	Evoline 20	Evoline 25	Evoline 20T	Evoline 25T	Evoline 35T
Weight	kg	33	48	54	60	68	92	99	92	103	120
A	mm	798	958	1015				1080		1080	
B	mm	511	581	621				708		1258	
C	mm	293	360	370				416		446	
D	mm	100	115	111		98.5		99			
E	mm	335	365	411		498.5		499		599	

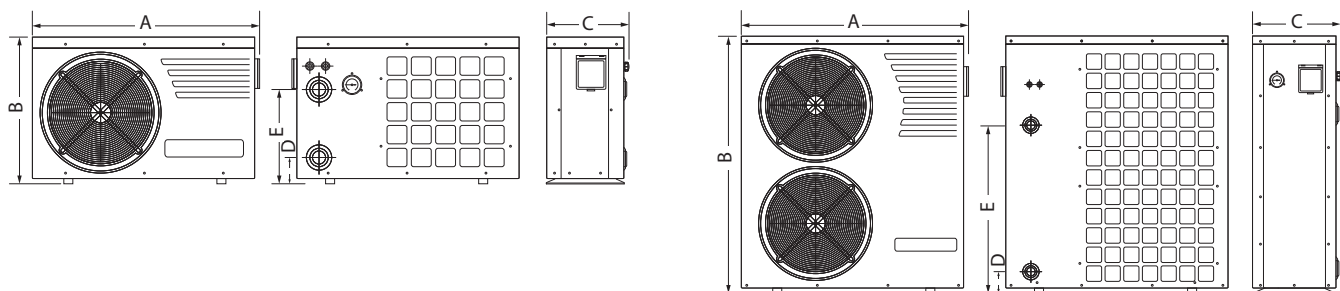

For complete technical & dimensional details, refer to the datasheet/user manual.

HEAT PUMPS SELECTION GUIDE

Parameters of the quick selection guide

This quick selection guide has been configured with the following parameters: private pool, for a use from beginning of may to end of september, average depth 1.5m, 14h filtration time, target pool water temperature 28°C.

Select my heat pump in less than 1 minute

For a 35m³ pool, with cover, located in zone 4, an EVOLINE 13 is needed*.

*To find the corresponding pool location zone, consult our climate map in page 535.

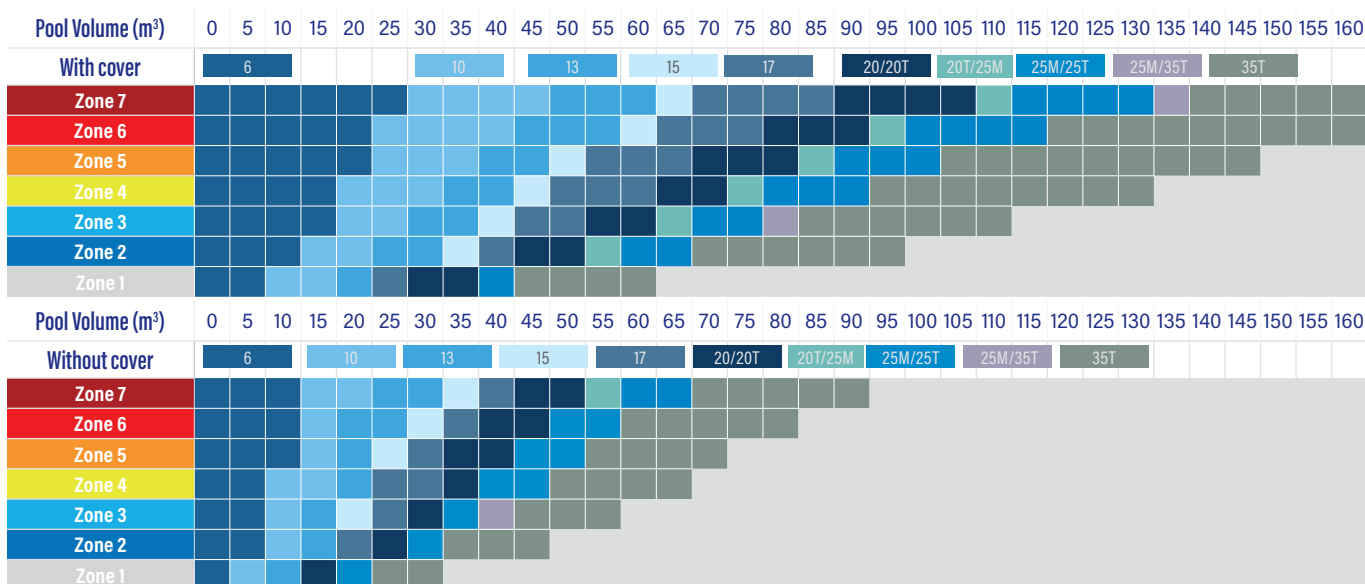

AstralPool recommends to use the web configurators to get a more accurate sizing (change pool shape, pool depth, target pool water temperature, period of use...).

For professional use, visit our configurator on Profluidra website.
For public use, visit our simplified configurator on AstralPool website.

Optima



<130m³

Includes Modbus connection

DESCRIPTION

- +5°C minimum outdoor air temperature.
- Robust, lightweight ABS casing made from magnesium coated aluminium.
- Standard: Operating as a heat pump with reverse cycle defrosting.
- Chiller: Providing heat or cold to maintain the temperature of the pool with reverse cycle defrosting.
- Scroll compressor.
- Titanium condensers made of PVC casing and TITANIUM G2 coil. Guaranteed against corrosion. It includes drainage for care in the winter.

TECHNICAL FEATURES

Model		OPTIMA-7	OPTIMA-15
Reference	CHILLER	45694-MOB	45696-MOB
Water flow	STANDARD	m ³ /h	12
	CHILLER	m ³ /h	16
Electric power supply	V/Ph/Hz	230/1/50	220/1/50

HEATING PERFORMANCE

Model		OPTIMA-7	OPTIMA-15
AIR 15°C / WATER 26°C			
Heating capacity	(kW)	8.9	16
Power consumption	(kW)	1.8	3.5
COP		4.9	4.6

COOLING PERFORMANCE

Chiller models		OPTIMA-7	OPTIMA-15
AIR 30°C / WATER 26°C			
Cooling capacity	(kW)	9.2	15.7
Power consumption	(kW)	2	3.9
EER		4.7	4.1
AIR 35°C / WATER 26°C			
Cooling capacity	(kW)	8.6	14.7
Power consumption	(kW)	2.2	4.3
EER		3.9	3.5

Operating limits and conditions: Maximum water temperature: 40 °C. Maximum water pressure on entering the machine: 3.5 bar.

STANDARD AND CHILLER MODELS - WEIGHT AND DIMENSIONS

Model		OPTIMA-7	OPTIMA-15
Weight	kg	-	-
A	mm	800	975
B	mm	801	1032
C	mm	880	1028
D	mm	173	173
E	mm	333	573

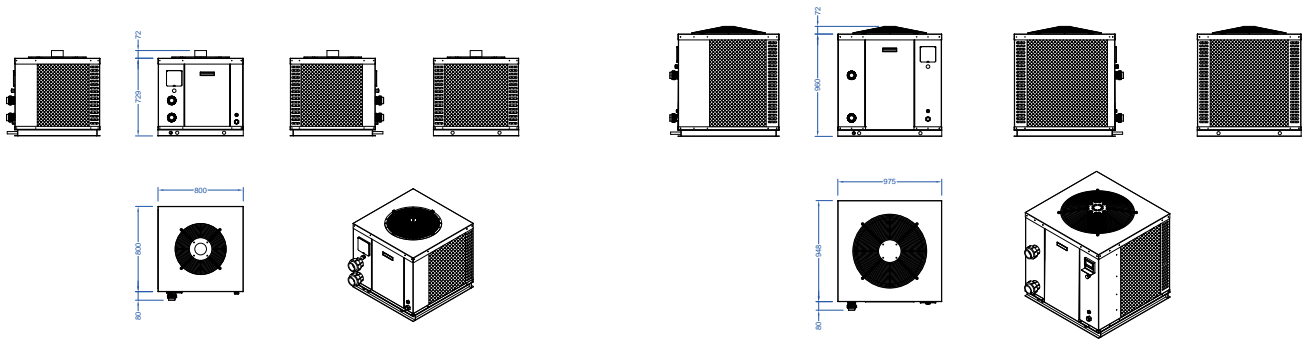

For complete technical & dimensional details, refer to the datasheet/user manual.

HEAT PUMPS SELECTION GUIDE

Parameters of the quick selection guide

This quick selection guide has been configured with the following parameters: private pool, for a use from beginning of may to end of september, average depth 1.5m, 14h filtration time, target pool water temperature 28°C.

Select my heat pump in less than 1 minute

For a 35m³ pool, with cover, located in zone 2, an OPTIMA-7 is needed*.

*To find the corresponding pool location zone, consult our climate map in page 535.

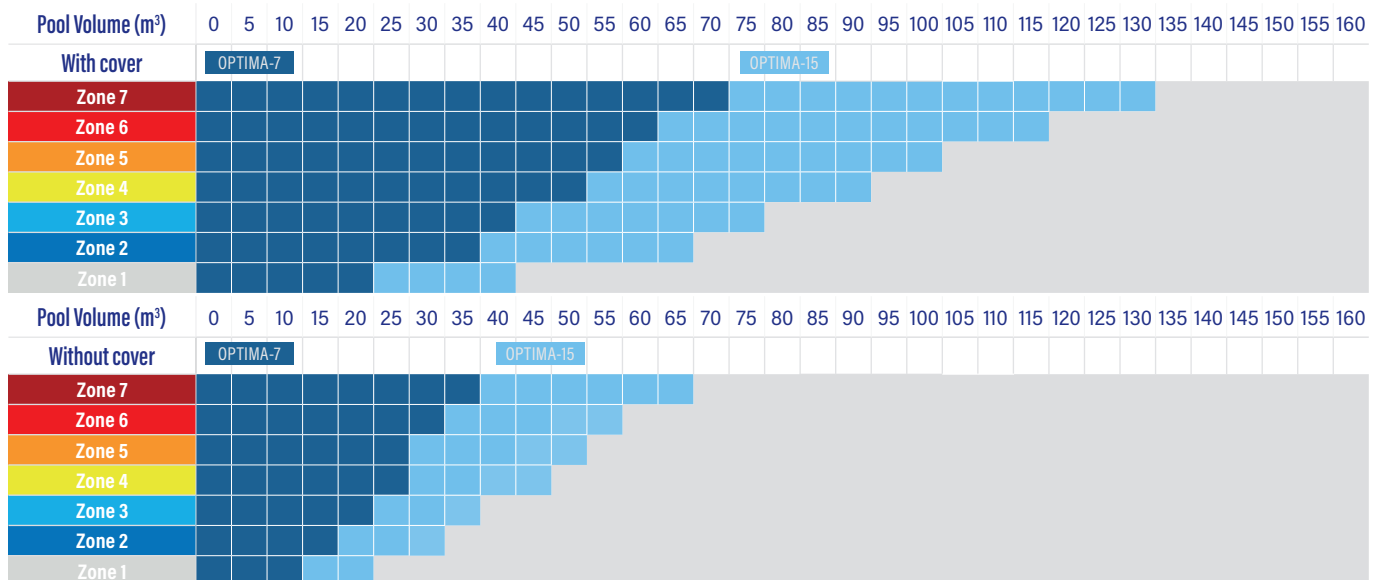

AstralPool recommends to use the web configurators to get a more accurate sizing (change pool shape, pool depth, target pool water temperature, period of use...).

For professional use, visit our configurator on Profluidra website.
For public use, visit our simplified configurator on AstralPool website.

Maya



<205m³

Includes Modbus connection

DESCRIPTION

- +5°C minimum outdoor air temperature.
- Compact design for installation in a pump room.
- Made of non-corrosive magnesium coated aluminium.
- Direct transmission centrifugal ventilator.
- Scroll compressor.
- Titanium condensers with PVC shells and in G2 titanium coil according to ASTM B 338.99 standard. Guaranteed against corrosion.

TECHNICAL FEATURES

Model		MAYA-15	MAYA-25
Reference		32505-MOB	32506-MOB
Recommended water flow	m ³ /h	7	8
Air flow	m ³ /h	2500	6000
Hydraulic connection	mm	50	
Electric power supply	V/Ph/Hz	400/3/50	
Refrigerant fluid quantity	Kg	2.5	4.5

HEATING PERFORMANCE

Model		MAYA-15	MAYA-25
AIR 15°C / WATER 26°C			
Heating capacity	(kW)	16.3	24.8
Power consumption	(kW)	3.6	5.7
COP		4.5	4.3

Operating limits and conditions: Maximum water temperature: 36 °C. Maximum water pressure on entering the machine: 3.5 bar.

STANDARD AND CHILLER MODELS - WEIGHT AND DIMENSIONS

Model			MAYA-15	MAYA-25
Weight	kg			
Dimensions	mm	A	854	1055
		B	1300	1735
		C	784	784
		D	234	234
		E	482	482

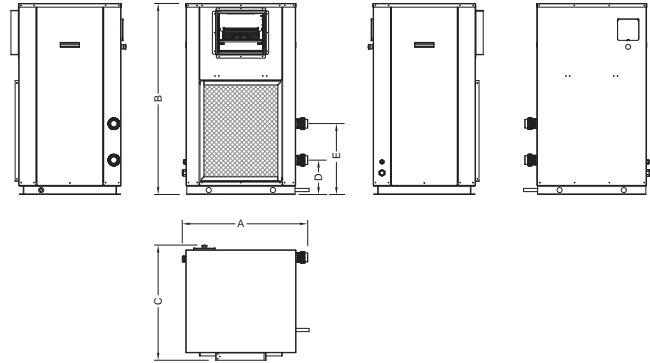

For complete technical & dimensional details, refer to the datasheet/user manual.

HEAT PUMPS SELECTION GUIDE

Parameters of the quick selection guide

This quick selection guide has been configured with the following parameters: private pool, for a use from beginning of may to end of september, average depth 1.5m, 14h filtration time, target pool water temperature 28°C.

Select my heat pump in less than 1 minute

For a 35m³ pool, with cover, located in zone 4, a Maya-15 is needed*.

*To find the corresponding pool location zone, consult our climate map in page 535.

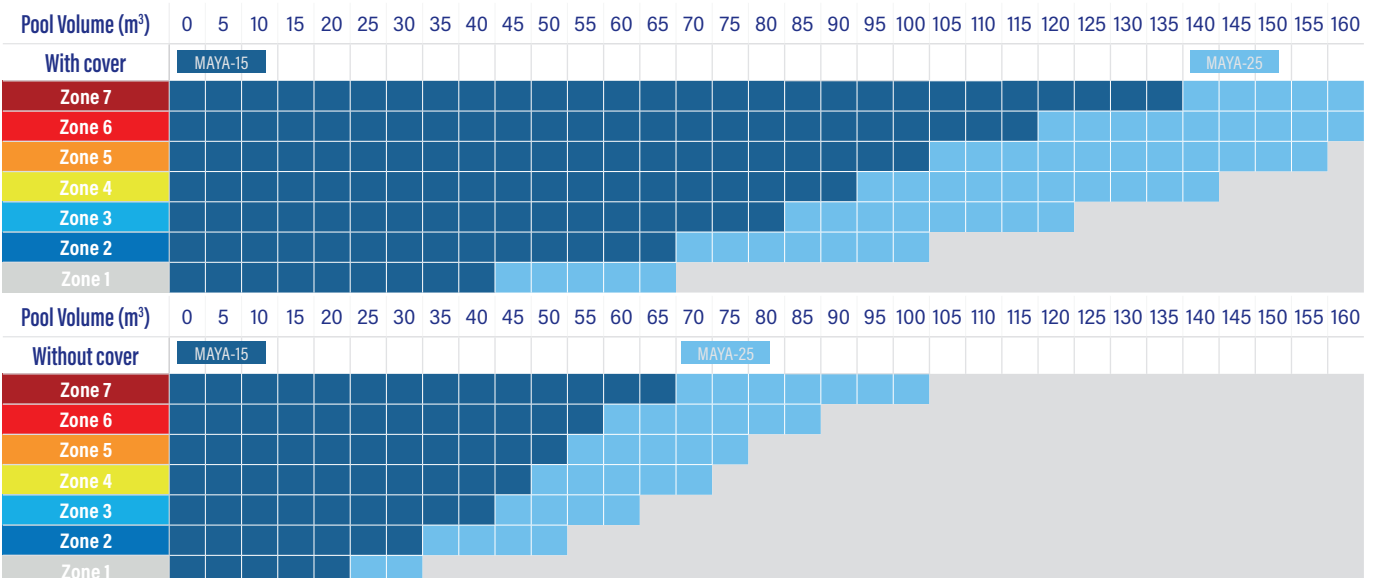

AstralPool recommends to use the web configurators to get a more accurate sizing (change pool shape, pool depth, target pool water temperature, period of use...).

For professional use, visit our configurator on Profluidra website.
For public use, visit our simplified configurator on AstralPool website.

Alaska - Siberia



ALASKA



SIBERIA



Includes Modbus connection

The fan is fitted vertically in the Alaska 10, 15 and 17 models

DESCRIPTION

- +5°C minimum outdoor air temperature.
- 2 compact models: For outdoor (Alaska) or indoor (Siberia) installation.
- Digital display.
- Heating priority (filtration pump control).
- Made of non-corrosive magnesium coated aluminium.
- Helicoidal ventilators with direct coupling motor for the Alaska model, centrifugal for the Siberia model.
- Defrosting thermostat in evaporator for enhanced performance.
- HP & LP safety pressure switch.
- Water flow switch.
- Condensor made of copper pipe with coated aluminium fins (special for corrosive environments).
- Scroll compressor with carter resistance and deoxidized copper.
- Thermostatic expansion valve.
- Titanium evaporator with PVC shell and in G2 titanium coil according to ASTM B 338.99 standard. Guaranteed against corrosion.
- Anti-acid dehydrating filter.

TECHNICAL FEATURES

Model		ALASKA-4	ALASKA-6	ALASKA-8	ALASKA-10	ALASKA-15	ALASKA-17	
Reference		32535-MOB	32536-MOB	32537-MOB	32538-MOB	32540-MOB	32541-MOB	
Model		SIBERIA-4	SIBERIA-6	SIBERIA-8	SIBERIA-10	SIBERIA-15	SIBERIA-17	
Reference		33301-MOB	33302-MOB	33303-MOB	33304-MOB	33306-MOB	33307-MOB	
Refrigerant FLUID		R-407C						
Recommended pool volume	m ³	5-9	7-14	10-20	13-26	18-36	25-50	
Recommended water flow	m ³ /h	6-10	6-10	7-12	7-12	10-15	10-15	
Air flow	m ³ /h	3800	4900	5500	9800	11000		
Hydraulic connection	mm	50						
Electric power supply	V/Ph/Hz	230/1/50			400/3/50			
Refrigerant fluid quantity	Kg	2	4.3	4.8	5.5	6.3	6.6	
Number of fans		1				2		

COOLING PERFORMANCE

Alaska models		ALASKA-4	ALASKA-6	ALASKA-8	ALASKA-10	ALASKA-15	ALASKA-17
AIR 27°C / WATER 12°C							
Cooling capacity	(kW)	4.4	5.7	8.9	10.7	16.6	22.7
Power consumption	(kW)	1.3	2.0	2.8	3.6	5.0	6.6
EER		3.3	2.9	3.1	3.0	3.4	3.5
Siberia models		SIBERIA-4	SIBERIA-6	SIBERIA-8	SIBERIA-10	SIBERIA-15	SIBERIA-17
AIR 27°C / WATER 12°C							
Cooling capacity	(kW)	4.4	5.7	8.9	10.7	16.6	22.7
Power consumption	(kW)	1.8	2.3	3.2	4.5	7.7	9.3
EER		2.4	2.5	2.8	2.4	2.2	2.5

Maximum air temperature 40°C, minimum water temperature 10°C. Maximum water pressure 3.5 bar.

STANDARD AND CHILLER MODELS - WEIGHT AND DIMENSIONS

Model			ALASKA-4	ALASKA-6	ALASKA-8	ALASKA-10	ALASKA-15	ALASKA-17
Weight	kg		80	92	102	133	167	197
Dimensions	mm	A	1311 (+80)		1411 (+80)	1372 (+80)	1728 (+80)	
		B	512	540	556	650	708	
		C	746		846	890	866	
Model			SIBERIA-4	SIBERIA-6	SIBERIA-8	SIBERIA-10	SIBERIA-15	SIBERIA-17
Weight	kg		97	112	120	188	219	224
Dimensions	mm	A	1311 (+80)		1411 (+80)	1372 (+80)	1728 (+80)	
		B	550+50	700+50		655+50	655+50	
		C	746		846	890	866	

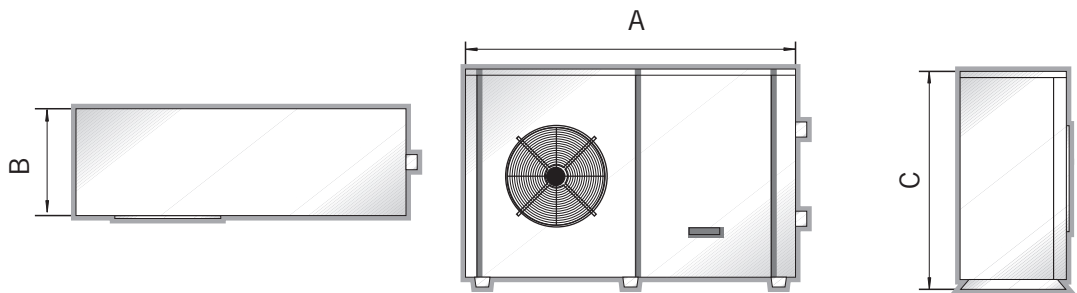

Compact ElectricHeat

Electronic model

Mechanical model (Eco)

 Fluidra Connect compatible
Titanium models only

<145M³

- + From 3 to 18kW
- + Electronic models for more comfort
- + Titanium resistances models compatible with salt pools

DESCRIPTION

- Linear configuration that offers ease of installation.
- OLED display for electronic models
- LCD display for mechanical model
- Incoloy or Titanium resistances models
- Single or 3 phase wiring
- Simple and fast electrical connection system.
- Replaceable parts: the internal components are easy to access and replace.

PRODUCT REFERENCES

ELECTRONIC MODELS	COMPACT 3	COMPACT 6	COMPACT 9	COMPACT 12	COMPACT 18
Incoloy version	60170	60171	60172	60173	60174
Titanium version	65321	65322	65323	65324	65325
MECHANICAL MODELS	ECO 3	ECO 6	ECO 9	ECO 12	ECO 18
ECO Incoloy version	69193	69194	69195	69196	69197

HEATING PERFORMANCES & TECHNICAL FEATURES

ELECTRONIC MODELS		COMPACT 3	COMPACT 6	COMPACT 9	COMPACT 12	COMPACT 18
MECHANICAL MODELS		ECO 3	ECO 6	ECO 9	ECO 12	ECO 18
Power	kW	3	6	9	12	18
Electrical supply*	V/Ph/Hz	230 / 1 / 50-60 or 400 / 3 / 50-60				400 / 3 / 50-60
Min. Water flow rate	m ³ /h	2.4				
Max. Water flow rate	m ³ /h	15				
Water connection	mm Ø	50/63				
Maximum operating power (A)	220V/50Hz/1PH	14	27	41	-	-
	400V/50Hz/3PH	5	9	14	18	27

*In the case of 230/1/50-60, check special code.

NB: INCOLOY models do NOT provide protection for salt electrolysis facilities, so this type of facility should use the TITANIUM model to prevent operational problems that would not be covered under warranty.

TECHNICAL FEATURES						
ELECTRONIC MODELS		COMPACT 3	COMPACT 6	COMPACT 9	COMPACT 12	COMPACT 18
MECHANICAL MODELS		ECO 3	ECO 6	ECO 9	ECO 12	ECO 18
Gross weight	kg				4.8	
Net weight	kg				4.2	

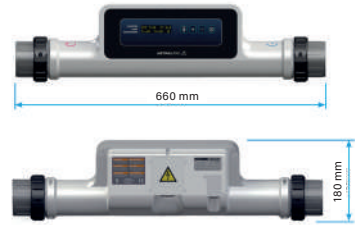

Electronic model

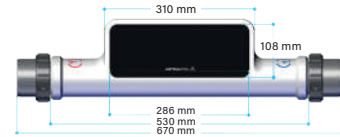

Mechanical model (Eco)

ELECTRIC HEATERS SELECTION GUIDE

Parameters of the quick selection guide

This quick selection guide has been configured with the following parameters: private pool, for a use from beginning of may to end of september, average depth 1.5m, 14h filtration time, target pool water temperature 28°C.

Select my heat pump in less than 1 minute

For a 35m³ pool, with cover, located in zone 2, a Electricheat 9 is needed*.

*To find the corresponding pool location zone, consult our climate map in page 535.

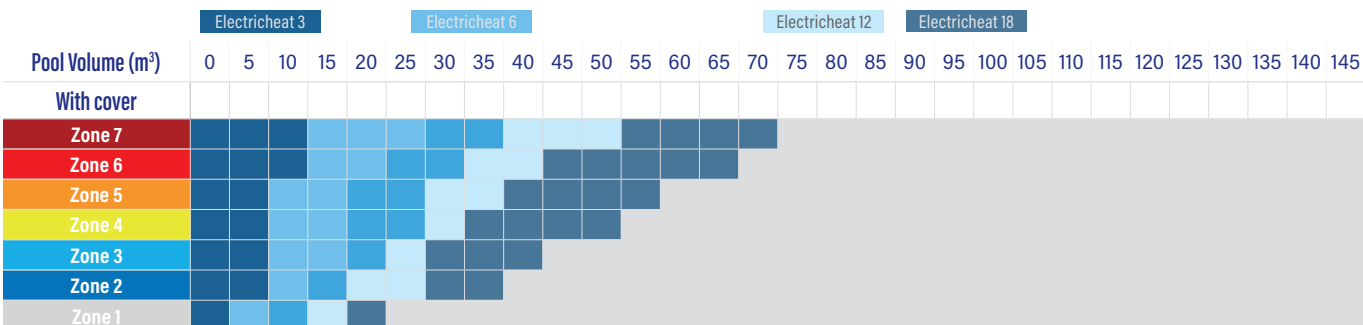
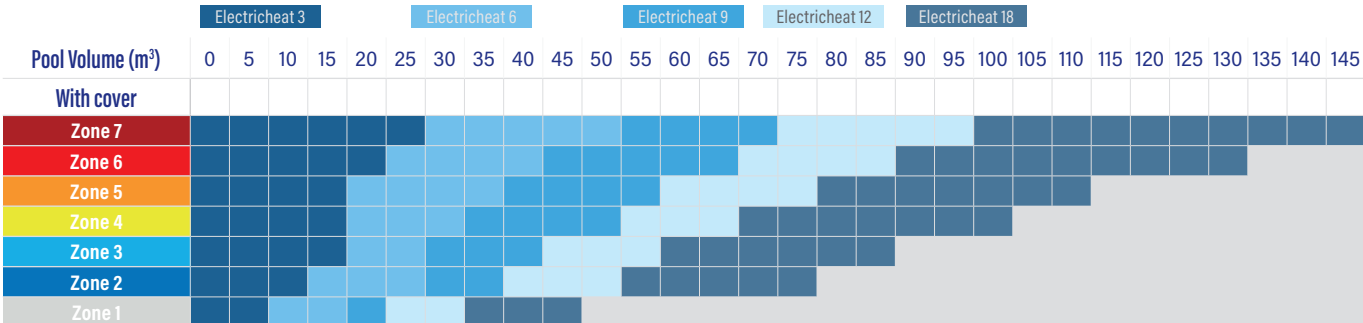

AstralPool recommends to use the web configurators to get a more accurate sizing (change pool shape, pool depth, target pool water temperature, period of use...).

For professional use, visit our configurator on www.pro.fluidra.com
For public use, visit our simplified configurator on www.astralpool.com

Equipped Waterheat



DESCRIPTION

Heat exchanger suitable for warming the water temperature of pools and SPAS, thanks to the heat exchange between the primary circuit (warm area) and a secondary one (cold area that we want to warm).

- Regulator with secondary pump control, voltage free contact and timer.
- Casing built in Alucoil and ABS plastic.
- Body made in Titanium (secondary, water from pool).
- Coils made in titanium alloy (primary, water from boiler).
- Fully fitted, anti-return valve, primary recirculation pump and control thermostat with immersion probe.
- Primary work pressure 10 bars and secondary work pressure 3 bars.

CONNECTIONS:

- Primary (heating): 1".
- Secondary (pool): D-50 three piece link.

PRODUCT REFERENCES

Model	TIT-20 kW	TIT-40 kW	TIT-60 kW
Reference	43506	43507	43508

TECHNICAL FEATURES

Model		TIT-20 kW	TIT-40 kW	TIT-60 kW
Power	90°C	20	40	60
	60°C	10	20	30
	45°C	5	10	15

HEATING PERFORMANCE

Model		TIT-20 kW	TIT-40 kW	TIT-60 kW
Heater	m ³ /h	1.6	2.7	3.0
Heater load loss	bar	0.12	0.41	0.70
Heater connection	Inch		-	
Pool volume	m ³ /h	10	15	20
Pool head loss	bar	0.14	0.24	0.29
Pool connection	Inch	-	-	-

DIMENSIONS AND WEIGHT

Model		TIT-20 kW	TIT-40 kW	TIT-60 kW
Dimensions 	A (mm)	530	530	530
	B (mm)	450	590	650
	C (mm)	160	160	160
	D (mm)	215	225	305
	E (mm)	1"	1"	1"
Weight	kg	10	11	18

Consult your service engineer about the right selection of unit depending on your installation.

Figures for power settings calculated for pool water at 20°C.

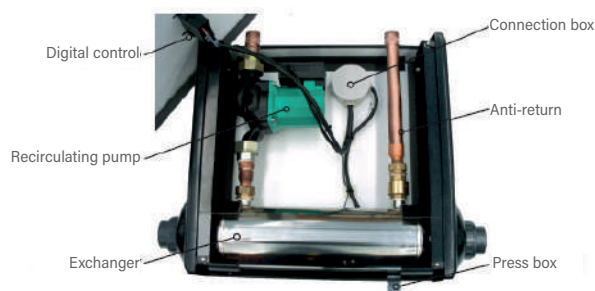
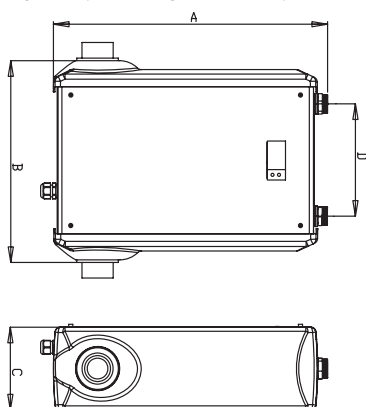

HEAT EXCHANGERS

Waterheat EVO



DESCRIPTION

Heat exchanger suitable for warming the water temperature of pools and SPAS, thanks to the heat exchange between the primary circuit (warm area) and a secondary one (cold area that we want to warm).

- Titanium housing (secondary, pool water).
- Titanium coil (primary, water for boiler).
- Primary working pressure of 10 bar.
- Secondary working pressure of 3 bar.

PRODUCT REFERENCES

Model	TIT-20 kW	TIT-40 kW	TIT-60 kW	TIT-105 kW	TIT-140 kW	TIT-210 kW	TIT-300 kW	TIT-450 kW
Reference	71607	71608	71609	71610	71611	71612	71613	71614

TECHNICAL FEATURES

Model		TIT-20 kW	TIT-40 kW	TIT-60 kW	TIT-105 kW	TIT-140 kW	TIT-210 kW	TIT-300 kW	TIT-450 kW
Power	90°C	20	40	60	105	140	210	300	450
	60°C	10	20	30	40	60	80	120	210
	45°C	5	10	15	20	3	40	60	100

HEATING PERFORMANCE

Model		TIT-20 kW	TIT-40 kW	TIT-60 kW	TIT-105 kW	TIT-140 kW	TIT-210 kW	TIT-300 kW	TIT-450 kW
Heater	m ² /h	1.6	2.7	3.1	6.6	7.0	10.0	11.0	16.0
Heater load loss	bar	0.006	0.024	0.040	0.030	0.040	0.122	0.214	0.470
Heater connection	Inch	G ¾"			G 1½"				
Pool head loss	bar	0.119	0.192	0.418	0.293	0.316	0.633	0.596	0.860
Pool connection	Inch	G 1"		G 1½"					

DIMENSIONS AND WEIGHT

Model		TIT-20 kW	TIT-40 kW	TIT-60 kW	TIT-105 kW	TIT-140 kW	TIT-210 kW	TIT-300 kW	TIT-450 kW	
Dimensions		A (mm)			140					
		B (mm)	75	175	225	170	270	420	670	920
		C (mm)	290	390	440	357	457	607	857	1107
		Ø Dz	80			102				
	Weight	kg	1.2	1.7	1.9	2.2	2.7	3.8	5.3	6.8

Consult your service engineer about the right selection of unit depending on your installation.

Figures for power settings calculated for pool water at 20°C.

Diagram of assembly below the water level:

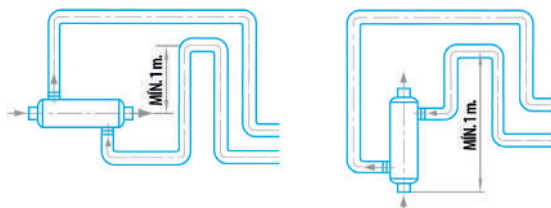
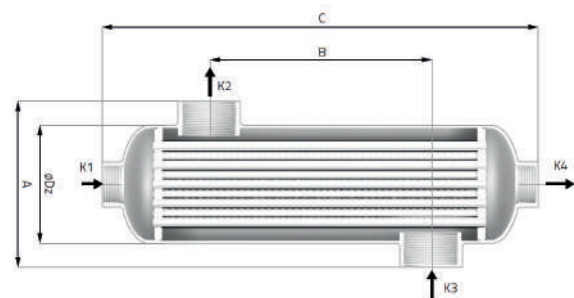
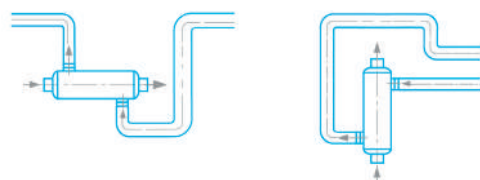

Diagram of assembly below the water level:



Etna



Basic model

- Corrugated plates in AISI-316 or titanium.
- EPDM gaskets.
- Housing in epoxy painted carbon steel.
- In non-equipped heat exchangers, AISI-316 stainless steel connections in ISO G2 direct thread.
- In equipped heat exchangers, primary connections in copper, and secondary in PVC.
- In equipped heat exchangers, full regulation, with control of the filtering pump. Double display (setpoint and current reading).
- Simple recirculating pump in the primary circuit is optional.



Equipped model

ETNA 15 - ETNA 200

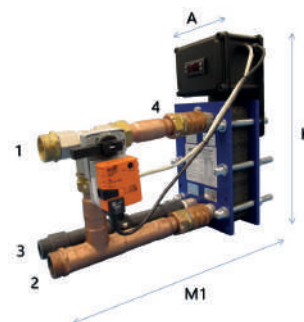
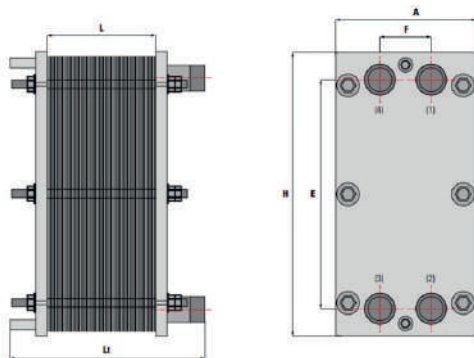

Equipped model + recirculating pump

ETNA 250 - ETNA 580

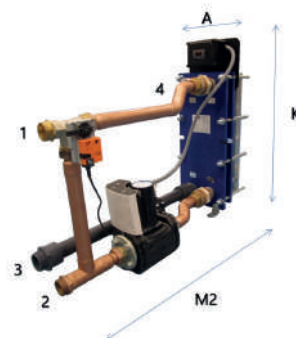
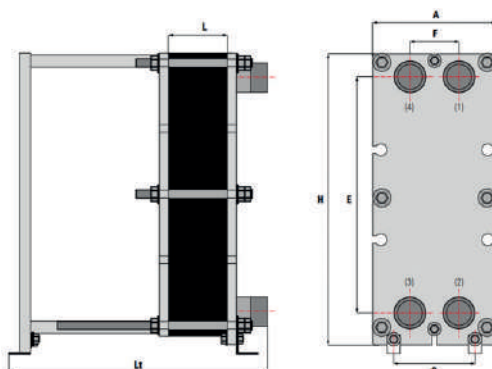

- 1 – Primary, inlet.
- 2 – Primary, outlet.
- 3 – Secondary, inlet.
- 4 – Secondary, outlet.

PRODUCT REFERENCES

Model	AISI-316 codes			Titanium codes		
	Basic model	Equipped model	Model Eq+B ⁽¹⁾	Basic model	Equipped model	Model Eq+B ⁽¹⁾
	Ref.	Ref.	Ref.	Ref.	Ref.	Ref.
ETNA-15	67985	68230	68021	67994	68012	68030
ETNA-35	68223	68004	68022	67995	68013	68031
ETNA-50	68224	68005	68023	67996	68014	68032
ETNA-60	68225	68006	68024	67997	68015	68033
ETNA-90	67989	68007	68025	67998	68016	68034
ETNA-120	67990	68008	68026	68226	68017	68035
ETNA-150	67991	68009	68027	68227	68018	68036
ETNA-180	67992	68010	68028	68228	68019	68037
ETNA-200	67993	68011	68029	68229	68020	68038
ETNA-250	32550	32563	32576	33137	33155	33173
ETNA-300	32552	32565	32578	33139	33157	33175
ETNA-350	32553	32566	32579	33140	33158	33176
ETNA-400	33114	33119	33124	33141	33159	33177
ETNA-460	33115	33120	33125	69796	33160	33178
ETNA-500	32554	32567	32580	69797	33161	33179
ETNA-580	33116	33121	33126	69798	33162	33180

(1) Eq + B: Equipped model + recirculating pump.

TECHNICAL FEATURES

Model	Code		Power		Num. Plates	Primary circuit			Secondary circuit			Dimensions (mm)					
	Basic models AISI-316	Basic models Titanium	KW	(kcal/h)		Flow rate (m³/h)	Head loss (bar)	Connections	Flow rate (m³/h)	Head loss (bar)	Connections	H	A	E	F	Lt	L
ETNA-15	67985	67994	17	15,000	5	0.75	0.3	11/4"	0.74	0.3	11/4"	320	200	235	69	220	16.5
ETNA-35	68223	67995	40	35,000	7	1.55	0.3	11/4"	1.52	0.3	11/4"	320	200	241	69	220	23.1
ETNA-50	68224	67996	58	50,000	9	2.56	0.3	11/4"	2.51	0.3	11/4"	320	200	235	69	220	29.7
ETNA-60	68225	67997	70	60,000	11	3.09	0.3	11/4"	3.03	0.3	11/4"	320	200	235	69	220	36.3
ETNA-90	67989	67998	105	90,000	15	4.64	0.3	11/4"	4.55	0.3	11/4"	320	200	235	69	220	49.5
ETNA-120	67990	68226	140	120,000	19	6.19	0.3	11/4"	6.07	0.3	11/4"	320	200	235	69	220	62.7
ETNA-150	67991	68227	174.4	150,000	23	7.71	0.3	11/4"	7.56	0.3	11/4"	320	200	235	69	220	75.9
ETNA-180	67992	68228	209	180,000	29	9.23	0.3	11/4"	9.06	0.3	11/4"	320	200	235	69	220	95.7
ETNA-200	67993	68229	233	200,000	31	10.3	0.3	11/4"	10.1	0.3	11/4"	320	200	235	69	220	102.3
ETNA-250	32550	33137	291	250,000	15	12.86	0.3	2 1/2"	12.61	0.3	2 1/2"	745	310	603	124	630	49.5
ETNA-300	32552	33139	349	300,000	17	15.42	0.3	2 1/2"	15.13	0.3	2 1/2"	745	310	603	124	630	56.1
ETNA-350	32553	33140	407	350,000	21	17.98	0.3	2 1/2"	17.64	0.3	2 1/2"	745	310	603	124	630	69.3
ETNA-400	33114	33141	465	400,000	23	20.55	0.3	2 1/2"	20.13	0.3	2 1/2"	745	310	603	124	630	75.9
ETNA-460	33115	69796	535	460,000	27	23.64	0.3	2 1/2"	23.19	0.3	2 1/2"	745	310	603	124	630	89.1
ETNA-500	32554	69797	581	500,000	29	25.67	0.3	2 1/2"	25.18	0.3	2 1/2"	745	310	603	124	630	95.7
ETNA-580	33116	69798	675	580,000	33	29.83	0.3	2 1/2"	29.26	0.3	2 1/2"	745	310	603	124	630	108.9

TECHNICAL FEATURES

Model	Code		Code		Power		Num. Plates	Dimensions (mm)				Weight
	Equipped models AISI-316	Equipped models Titanium	Model Eq+B ⁽¹⁾ AISI-316	Model Eq+B ⁽¹⁾ Titanium	KW	(kcal/h)		A	M1	M2	K	kg
ETNA-15	68230	68012	68021	68030	17	15.000	5	200	659	1148	470	38 + 4,5
ETNA-35	68004	68013	68022	68031	40	35.000	7	200	659	1148	470	38 + 4,5
ETNA-50	68005	68014	68023	68032	58	50.000	9	200	659	1148	470	39 + 9
ETNA-60	68006	68015	68024	68033	70	60.000	11	200	659	1148	470	39 + 9
ETNA-90	68007	68016	68025	68034	105	90.000	15	200	659	1148	470	40 + 9
ETNA-120	68008	68017	68026	68035	140	120.000	19	200	659	1148	470	41 + 15
ETNA-150	68009	68018	68027	68036	174,4	150.000	23	200	659	1148	470	42 + 15
ETNA-180	68010	68019	68028	68037	209	180.000	29	200	659	1148	470	43 + 15
ETNA-200	68011	68020	68029	68038	233	200.000	31	200	659	1148	470	44 + 15
ETNA-250	32563	33155	32576	33173	291	250.000	15	310	1070	1558	905	128 + 17
ETNA-300	32565	33157	32578	33175	349	300.000	17	310	1070	1558	905	129 + 17
ETNA-350	32566	33158	32579	33176	407	350.000	21	310	1070	1558	905	133 + 20
ETNA-400	33119	33159	33124	33177	465	400.000	23	310	1070	1558	905	134 + 20
ETNA-460	33120	33160	33125	33178	535	460.000	27	310	1070	1558	905	138 + 22
ETNA-500	32567	33161	32580	33179	581	500.000	29	310	1070	1558	905	139 + 22
ETNA-580	33121	33162	33126	33180	675	580.000	33	310	1070	1558	905	143 + 24

(1) Eq + B: Equipped model + recirculating pump.



Plug & Play
Customizable Fountains

PROJECT VIEW

66979 PLUG & PLAY KIT SPEAR



66982 PLUG & PLAY KIT MUSHROOM



66981 PLUG & PLAY KIT VULCAN

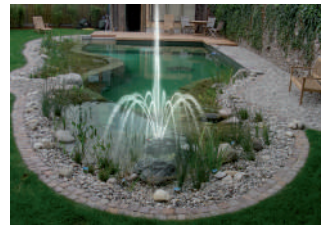

66980 PLUG & PLAY KIT FOAMY

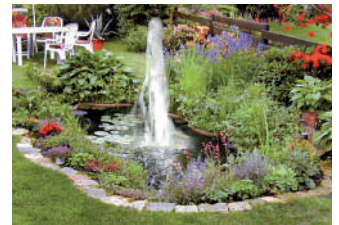

PLUG & PLAY CUSTOMIZABLE FOUNTAINS

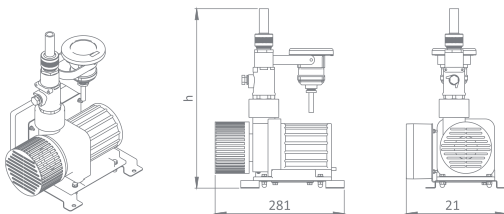

The Plug and Play fountain kit let you have a small complete fountain into your garden. It combines comfort, design and energy efficiency in a easy and quick product to install.

It comes with 10 meter cable, a nozzle and a multicolor RGB light included. The nozzle can be replaced by any other nozzle of our plug and play series to configure the fountain to your preference.

The highly efficient RGB LED with color changing sequence brings color into the pond.

The jet height is adjustable up to 3.5 meters, according to the installed nozzle.

PLUG & PLAY	66979 KIT SPEAR D12	66980 KIT FOAMY 35	66981 KIT VULCANO	66982 KIT MUSHROOM
Dimensions (L x W x H) [mm]	281 x 218 x 390	281 x 218 x 434	281 x 218 x 354	281 x 218 x 565
Connection	1" G	1" G	1" G	1" G
Nozzle material	Stainless Steel 304	Plastic / Stainless Steel 304	Stainless Steel 316	Stainless Steel 316
Pump	24 VDC / 105 W (Power supply included)	24 VDC / 105 W (Power supply included)	24 VDC / 105 W (Power supply included)	24 VDC / 105 W (Power supply included)
LED lighting	12 VAC / 4 W (Transformer/select button included)	12 VAC / 4 W (Transformer/select button included)	12 VAC / 4 W (Transformer/select button included)	12 VAC / 4 W (Transformer/select button included)
Max. Height	2,5 m	1 m	2 m	1 m (Diameter)

An aerial photograph of a swimming pool with clear turquoise water. Two people are floating on large, colorful inflatable rings. The man on the left is wearing blue shorts and sunglasses, resting on a ring with rainbow stripes. The woman on the right is wearing a pink bikini and a white sun hat, resting on a ring with a colorful confetti pattern. The pool is bordered by a wooden deck at the top and a sandy beach at the bottom. Palm fronds are visible in the corners. A white wavy line graphic curves across the top and bottom of the pool area.

FLUIDRA

COMMERCIAL

POOLS & WELLNESS

2022

ASTRALPOOL 

 **CEPEX**

ctx
pro

**PISCINE
LAGHETTO**

Free chlorine

Salt chlorinators
+ UV (Neolysis)

PROPERLY TREATED COMMERCIAL POOLS



Air disinfection

Surface cleaning

UV treatment

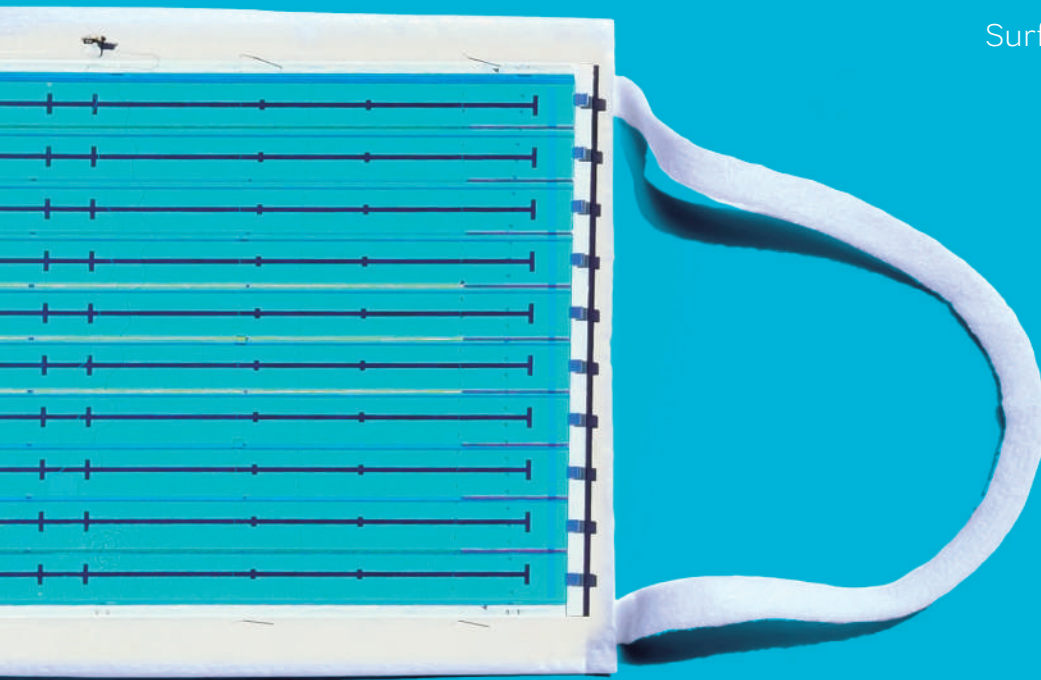

COMMERCIAL POOLS & WELLNESS FACILITIES **ARE SAFE PLACES**

A properly treated swimming pool
remain a safe place even with the new variants of the virus

ENJOY THE PERFECT
COMMERCIAL POOL &
WELLNESS EXPERIENCE IN
A **COVID-FREE SPACE**

ASTRALPOOL 

ctx[®]
pro

#EnjoyaSafePool

FLUIDRA
THE PERFECT POOL EXPERIENCE

  
@Fluidra Fluidra Fluidra Group

COMMERCIAL
POOLS
& WELLNESS





INTERNET OF POOLS

563



POOL SURROUND EQUIPMENT

573



POOL SHELL EQUIPMENT

617



BUILDING SOLUTIONS

635



FILTRATION

651



PUMPS

691



WATER TREATMENT EQUIPMENT

709



SPAS AND SAUNAS

737



DEHUMIDIFICATION

779



HEATING

785



COMPETITION MATERIALS

799



FOUNTAINS

819





COMMERCIAL POOLS

INTERNET OF POOLS



568 CONNECT & GO COMMERCIAL PRODUCTS

568 Connect & Go Commercial EASY

568 Connect & Go Commercial DIRECT

569 CONNECT & GO COMMERCIAL PRODUCTS

569 Connect & Go Commercial SMART

569 Connect & Go Commercial CONTROL PUMP CABINET

571 Fluidra Connect accessories

Smart Commercial Pools

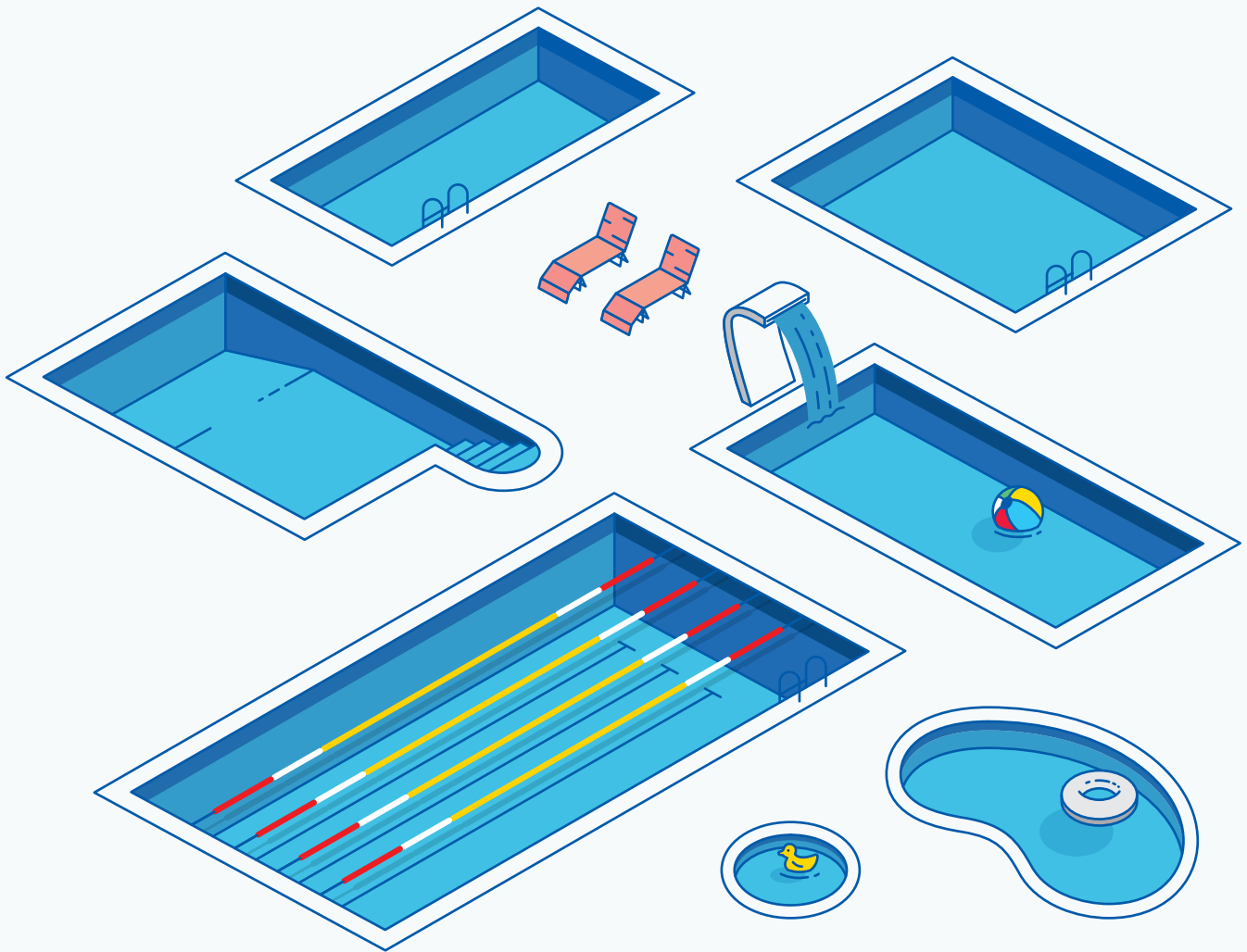

Connectivity for automation and monitoring
all types of commercial pools



24/7 Water Quality

Water quality controlled and monitored thanks to the pool equipments synchronized all together in a smart way. Alarm system for real-time corrective maintenance.



Energy Savings

With a combination of connected products and data assisted preventative maintenance actions to reach optimum energy efficiency.

Smart Pool Assistants for all type of pools

Control, diagnose and manage your pool through the fluidraconnect.com platform

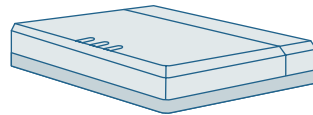

Through the Connect Box from your Connect & Go you will be able to control all types of products, compatible NN as well as the standard ones.



Filtration

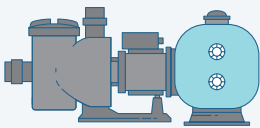

Set-up and control of pumps for energy-efficient programs and optimum filter cleanliness status.

Water treatment

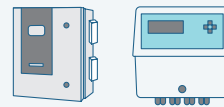

Integral water treatment strategy between all the pool systems. Recording all the measures as per local legislation requirements.

Lighting



Synchronization with other equipments to generate smart ambient.

Surround & Garden Equipment



Control all the pool and garden accessories easily: Covers, fountains, IP Cams, even irrigation systems.

Heating and Dehumidification



Smart heating strategy for energy optimization together with the filtration and the water treatment equipment.

Control the pools under your supervision from anyplace, whenever you want with our pool assistants platform Fluidra Connect.

www.fluidraconnect.com

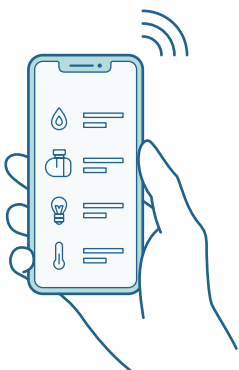

Fluidra Connect automation and NN Products for Commercial Pools

Fluidra Connect is a smart automation solution that allows both users and pool professionals to control pools remotely.

Different levels of remote control are offered depending on user profile:

THE FUTURE
IS HERE



▪ **End user:**

- User friendly NN app to remotely monitor and control the pool



▪ **Pool professional:**





- Intuitive and versatile NN PRO app to set up each pool and allows to monitor all installed pool sites.
- Advanced remote control of all installed pool sites using the dedicated pool professional website www.fluidraconnect.com.

All product platforms below are NN compatible to allow a smart control & exchange with Fluidra Connect and associated smartphone apps and website.

User(s) can see more operating data and be able to access to more settings compared to standard products.

Water Treatment Equipment

					
	Salt Water Chlorinators and Hybrid systems				
	Freepool²	Easy Salt Next	Pro-Chlore Salt	Nature Salt	Neolysis
More info on page	885	887	888	889	890

					
	Automatic Regulation and Control Equipment			Dosing Pumps	Water metering
	Guardian Pool	AP PR-200 Compatible Electrolysis	Controller	Optima pH / Redox	Woltman type turbine meters
More info on page	906	904	907	901	903

Pool Lighting

RGB LED lighting becomes "NN" with Lumiplus Modbus and modulator (57435)



LED Lighting

RGB lights

More info on page

420

Dehumidification



Dehumidification

Airpool

More info on page

961

Heating



Heat Pumps

ProHeat II

More info on page

972

THE FUTURE
IS HERE



- + Convenience & easy installation
- + A range of Connect & Go power center cabinets is offered to suit most commercial pools configurations.
- + Connect & Go Commercial power center cabinets contain all electrical protections and switches to manage pool equipment. Everything is pre-wired to ease installation process so it is the perfect solution for new pools, while also being adapted to retrofit situation (simply replace the whole cabinet with Connect & Go Commercial).
- + Fluidra Connect is a smart solution that enables end users and pool dealers to control a pool remotely. This makes it possible for pool dealers to check out, manage and control all the pools they have installed from a PC.

Connect & Go Commercial

EASY



DESCRIPTION

Control and power devices for up to 3 pump sets with direct start and control devices for balancing tank. The panel includes control devices for lightning.

- 3 Filtration Pumps (3-phase).
- 1 Lighting Control.
- Balancing tanks minimum level, filling level and maximum level.
- Transformer 24VAC filling valve.
- 3 Control pump switches M-0-A.
- 1 Lighting switch M-0-A.
- 1 Filling switch 0-A.
- 1 Digital input to monitor the filtration status and 1 digital inputs to monitor the motor circuit breakers.
- 2 Digital inputs to monitor maximum and minimum balancing tank level.

	Code	Standard Pack	Standard weight in kg	Standard volume in m ³
Easy (2 HP)	72272	1	-	-
Easy (3 HP)	72271	1	-	-

Connect & Go Commercial

DIRECT



DESCRIPTION

Control and power devices for up to 3 pump sets with direct start and control devices for balancing tank. The panel includes analog inputs, control of motorized valves in suction manifold and control devices for lightning.

- 3 Filtration Pumps (3-phase).
- 1 Lighting Control.
- 1 Aux. Output (max 10A).
- Balancing tanks minimum level, filling level and maximum level.
- Transformer 24VAC filling valve.
- 3 Control valves inlet pumps.
- 3 Control pump switches M-0-A.
- 1 Lighting switch M-0-A.
- 1 Filling switch 0-A.
- Real energy / Reactive energy / Apparent energy meter.
- 4 Analog inputs (4-20mA).
- 3 Digital inputs to monitor filtration pump status and 3 digital inputs to monitor the motor circuit breakers.
- 3 Digital inputs to monitor end of stroke.
- 2 Digital inputs to monitor maximum and minimum balancing tank level and 2 digital inputs for water-meter by pulses.
- 3 Available digital inputs and 4 available digital outputs (max 2A).

	Code	Standard Pack	Standard weight in kg	Standard volume in m ³
Direct (1 HP)	72720	1	-	-
Direct (2 HP)	72718	1	-	-
Direct (3 HP)	72719	1	-	-

Connect & Go Commercial

SMART



DESCRIPTION

Control and power devices for up to 3 pump sets with soft start and control devices for balancing tank. The panel includes analog inputs, control of motorized valves in suction manifold and control devices for lightning.

- 3 Filtration Pumps (3-phase).
- 1 Lighting Control.
- 1 Aux. Output (max 10A).
- Balancing tank minimum level.
- Balancing tank filling level.
- Balancing tank maximum level.
- Transformer 24VAC filling valve.
- 3 Control valves inlet pumps.
- 3 Control pump switches M-0-A.
- 1 Lighting switch M-0-A.
- 1 Filling switch 0-A.
- Real energy / Reactive energy / Apparent energy meter.
- 4 Analog inputs (4-20mA).
- 3 Digital inputs to monitor filtration pump status.
- 3 Digital inputs to monitor the motor circuit breakers.
- 3 Digital inputs to monitor end of stroke.
- 2 Digital inputs to monitor maximum and minimum balancing tank level.
- 2 Digital inputs for water-meter by pulses.
- 3 Available digital inputs and 4 Available digital outputs (max 2A).

	Code	Standard Pack	Standard weight in kg	Standard volume in m ³
Smart (3 HP)	72713	1	-	-
Smart (5.5 HP)	72714	1	-	-
Smart (7.5 HP)	72715	1	-	-
Smart (10 HP)	72716	1	-	-
Smart (12 HP)	72717	1	-	-

Connect & Go Commercial

CONTROL PUMP CABINET

DESCRIPTION

Control pump devices for commercial pools.

	Code	Standard Pack	Standard weight in kg	Standard volume in m ³
Control pump (up to 4 pumps)	70745	1	-	-
Control pump (up to 8 pumps)	70746	1	-	-



FLUIDRA CONNECT®

CONNECT & GO

**SMART
POOL**
Connected
hubs

Installation Diagram



CONNECT & GO POWER CENTER CABINET

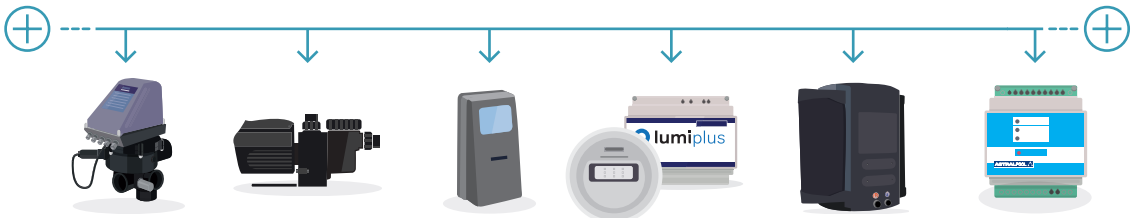

Smart control of "NN Thing" compatible products
(in addition to standard control: bilateral communication,
advanced status and messages, operational mode selection...)

GPIO*
Device with 4 inputs & 4 outputs provided
with Connect & Go
power center cabinet
to manage standard
products

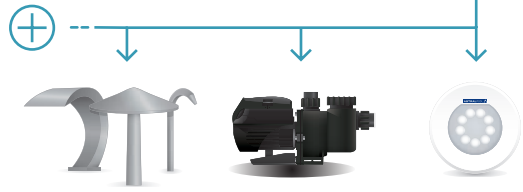

Standard control of any standard product
(on / off / scheduling / status)



Did you know?
Fluidra provides more than 100 products
able to offer a smart control and exchange
with Connect & Go pool automation.
Simply look for the "NN Thing" icon
in the product pages.

* 1 GPIO is installed inside Connect & Go power center cabinets. Additional GPIO can be purchased separately to control more equipment. See code 66671 in next page.

FLUIDRA CONNECT ACCESSORIES



Fluidra Connect accessories



	Code	Standard Pack	Standard weight in kg	Standard volume in m ³
Connect box	66671	1	-	-
GPI0	62368	1	-	-
230 VAC opto-isolator	66395	1	-	-
24 VAC opto-isolator	66396	1	-	-
Switch - 5 ports	66390*	1	-	-
Power Line Communications - 2 ports	66391*	1	-	-
Indoor Wi-Fi access point	66392*	1	-	-
Outdoor router	66393*	1	-	-
Portable router	66394*	1	-	-
3G router (requires SIM card)	67297*	1	-	-
3G router for DIN rail (requires SIM card)	67298*	1	-	-
SEM1 single-phase meter with transformer	68441	1	-	-
SEM3 single-phase meter with 3 transformers	68442	1	-	-
Bridge Modbus TCP/RTU	68168	1	-	-
Modbus temperature sensor kit	69682	1	-	-

* Available while stock lasts.



66395 - 66396



66671



62368



66392



66393



66394



67297



68441-68442



68168



COMMERCIAL POOLS

POOL SURROUND EQUIPMENT



574 POOL ACCESS

- 574 Ladders
- 575 Exit grab rails
- 578 Anchoring sockets and handrails
- 580 Disabled access

583 HANDRAILS

- 583 Handrails
- 584 Handrails attachment support

585 LIFE-SAVING

- 585 Lifeguard chairs
- 586 Life-saving accessories

587 SHOWERS

- 587 Showers with timers
- 587 Shower tunnels
- 588 Outdoor footbaths

589 WATER GAMES AND

ORNAMENTAL WATER FEATURES

- 589 Water curtains
- 593 Water cannons
- 596 Waterfalls
- 597 Umbrellas
- 598 Water mushrooms
- 600 Water features accessories
- 603 Water games
- 608 AstralPool Bike

609 GRILLES FOR OVERFLOW

Ladders

Overflow 1000 model



Complies with Standard
EN 13451-1
EN 13451-2

DESCRIPTION

Ladder width 500 mm Ø 43 mm handrail, non-slip surface stainless treads, bright satin finish, anchoring fixtures for connection to the equipotential circuit and removable anchoring with plate for fastening to wall. AISI-316L handrail and steps.

	Code	Standard Pack	Standard weight in kg	Standard volume in m ³
1 "Luxe" steps + 1 double safety step	07514	1	13.2	0.158
2 "Luxe" steps + 1 double safety step	07515	1	15.3	0.180
3 "Luxe" steps + 1 double safety step	07516	1	17.1	0.202
4 "Luxe" steps + 1 double safety step	07517	1	19.2	0.217

Code	Steps	A	B
07514	2	1450	700
07515	3	1710	960
07516	4	1970	1220
07517	5	2230	1480

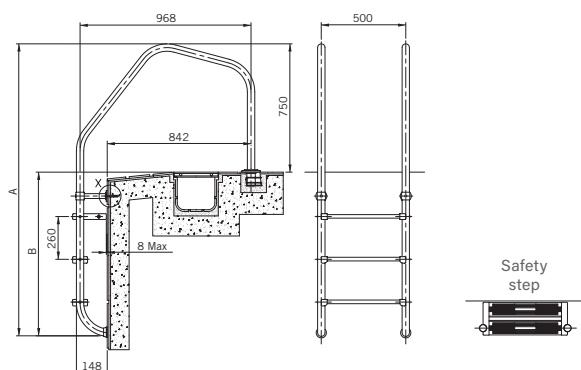

Ladder for swimming pools with overflow



Complies with Standard
EN 13451-1
EN 13451-2

DESCRIPTION

Includes variable radius curvature in grip section for a contemporary and attractive look. Steps 500 mm wide. Easy to install. Ø 43 mm x 1.5 mm handrail with AISI-316L bright satin finish stainless steel steps. Anchoring fixtures for connection to the equipotential circuit NB: Do not permit mounting on anchoring fixtures 00043, 08727, 07331, 18243.

	Code	Standard Pack	Standard weight in kg	Standard volume in m ³
2 steps ladder	32653	1	13.2	0.158
3 steps ladder	32654	1	16.2	0.180
4 steps ladder	32655	1	17.1	0.202
5 steps ladder	32656	1	19.2	0.217

Code	Steps	A	B
32653	2	1450	700
32654	3	1710	960
32655	4	1970	1220
32656	5	2230	1480

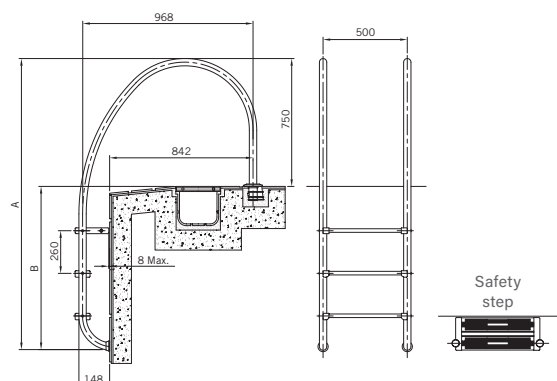

POOL ACCESS

Ladders



Complies with Standard
EN 13451-1
EN 13451-2

Double non-slip safety step

DESCRIPTION

AISI-316L stainless steel with bright satin finish. For all in-ground pool ladder models.

	Code	Standard Pack	Standard weight in kg	Standard volume in m ³
Safety step	70662	1	2.05	0.003

PMR ladder for public pools



Complies with Standard
EN 13451-2

DESCRIPTION

Public ladder manufactured in AISI-316L stainless steel. Polished finish. Step with non-slip punching.

	Code	Standard Pack	Standard weight in kg	Standard volume in m ³
3 steps ladder	64894	1	35.0	-
4 steps ladder	64895	1	41.0	-
5 steps ladder	64896	1	35.0	-
6-step ladder	64897	1	46.5	-
7-step ladder	64898	1	46.5	-
8-step ladder	64899	1	46.5	-

POOL ACCESS

Exit grab rails



*** 1 additional year warranty. For more information see the warranty certificate in the manual.**

800 x 800 mm model

DESCRIPTION

Set of 2 tubular handrails in polished S.S. AISI-316L Ø 43 mm pipe. Exit grab rails with fixing plates are supplied as a pair including fixing plates, gaskets, screws and wall plugs.

	Code	Standard Pack	Standard weight in kg	Standard volume in m ³
Attachment by means of fixing plate	05541	1	9.27	0.10
Attachment for embedding	05540	1	8.40	0.10

* 1 additional year warranty. For more information see the warranty certificate in the manual.



POOL ACCESS

Exit grab rails

470 x 800 mm model



DESCRIPTION

Set of 2 tubular handrails in polished S.S. AISI-316L Ø 43 mm pipe. Exit grab rails with fixing plates are supplied as a pair including fixing plates, gaskets, screws and wall plugs.

	Code	Standard Pack	Standard weight in kg	Standard volume in m ³
Attachment by means of fixing plate	05542	1	6.97	0.08

470 x 800 mm model

with rectangular base plate



DESCRIPTION

Set of 2 tubular handrails in polished S.S. AISI-316L Ø 43 mm pipe. The exit grab rails with base plates are supplied with screws and wall plugs.

	Code	Standard Pack	Standard weight in kg	Standard volume in m ³
Attachment by means of fixing plate	05543	1	7.6	0.08

Crossover model

with rectangular base plate



DESCRIPTION

Set of 2 tubular handrails in polished S.S. AISI-316L Ø 43 mm pipe. The exit grab rails with base plates are supplied with wall plugs and screws.

	Code	Standard Pack	Standard weight in kg	Standard volume in m ³
Attachment by means of fixing plate	05544	1	8.46	0.18

Parallel model



DESCRIPTION

Set of 2 tubular handrails in polished S.S. AISI-316L Ø 43 mm pipe. For fixing with anchoring fixture code 00143 (not included).

	Code	Standard Pack	Standard weight in kg	Standard volume in m ³
Parallel model	00110	1	10.0	0.11

POOL ACCESS

* 1 additional year warranty. For more information see the warranty certificate in the manual.



Exit grab rails

Asymmetrical model



DESCRIPTION

Set of 2 tubular handrails in polished S.S. AISI-316L Ø 43 mm pipe. For fixing with anchoring fixture code 00143 (not included).

	Code	Standard Pack	Standard weight in kg	Standard volume in m ³
Asymmetrical model	00111	1	10.1	0.14

Split ladder - Bottom half



Complies with Standard
EN 13451-1
EN 13451-2

DESCRIPTION

AISI-316L bright satin stainless steel steps and Ø 43 mm handrail. Can be combined with any ladder model. Fastening with plates, gaskets, wall plugs and screws.

	Code	Standard Pack	Standard weight in kg	Standard volume in m ³
1 "Luxe" step + 1 double safety step	08090	1	6.0	0.04
2 "Luxe" steps + 1 double safety step	08091	1	7.6	0.04
3 "Luxe" steps + 1 double safety step	08092	1	9.0	0.05
4 "Luxe" steps + 1 double safety step	08093	1	10.5	0.07

Grab rails, fixed in and out of the water



DESCRIPTION

Polished AISI-316 stainless steel. Ø 43 mm.

	Code	Standard Pack	Standard weight in kg	Standard volume in m ³
For embedding				
2 units. Length 1,220 mm	00034	1	11.4	0.14
2 units. Length 1,524 mm	00035	1	13.0	0.16
With base plates (gaskets, wall plugs and screws)				
2 units. Length 1,220 mm	00036	1	12.2	0.21
2 units. Length 1,524 mm	00037	1	13.6	0.24

Grab rail fixed out of the water



DESCRIPTION

In polished AISI-316L stainless steel (Ø 43 mm).

	Code	Standard Pack	Standard weight in kg	Standard volume in m ³
For embedding	07780	1	6.7	0.118
With base plates (gaskets, wall plugs and screws)	07781	1	6.7	0.118

Anchoring sockets and handrails



Anchoring sockets



DESCRIPTION

Made of plastic, with earth connection.

	Code	Standard Pack	Standard weight in kg	Standard volume in m ³
For Ø 43 mm pipe.	00042	50	7.0	0.03
For Ø 48 mm pipe.	07661	-	-	-



Articulated anchoring sockets



DESCRIPTION

In polished Stainless Steel (AISI-304L) for a ladder with a Ø 43 mm pipe.

	Code	Standard Pack	Standard weight in kg	Standard volume in m ³
Articulated anchoring socket without base plate	00043	1	0.93	0.002
with base plate	08727	1	1.0	0.002



Removable anchoring socket with base plate



DESCRIPTION

In polished stainless steel (AISI-316L) for a Ø 43 mm pipe with gaskets, wall plugs and screws.

	Code	Standard Pack	Standard weight in kg	Standard volume in m ³
Set of 2 units	07331	1	1.00	0.003



Anchor with locking bolts



DESCRIPTION

Made of polished AISI-316L stainless steel. For a Ø 43 mm pipe.

	Code	Standard Pack	Standard weight in kg	Standard volume in m ³
Anchoring sockets	00143	2	1.2	0.003

Anchoring sockets and handrails

POOL SURROUND EQUIPMENT



Ladder foot pad



DESCRIPTION

Made of plastic, the angle can be adjusted by rotating the eye ball socket. Recommended for liner pools.

	Code	Standard Pack	Standard weight in kg	Standard volume in m ³
For Ø 43 mm pipe	00045	50	12.6	0.03
For Ø 28 mm pipes	00046	50	14.0	0.03

Stainless Steel Handrails



DESCRIPTION

Polished Ø 43 mm AISI-316L stainless steel pipes. With fixing plates (including gaskets, screws and wall plugs).

	Code	Standard Pack	Standard weight in kg	Standard volume in m ³
Length 0.5 m	00051	2	2.8	0.02
Length 1 m	00052	2	4.3	0.04
Length 2 m	00053	2	7.9	0.09
Length 2.5 m	00054	2	9.5	0.11

Tee bar



DESCRIPTION

Polished Ø 43 mm AISI-316L stainless steel pipes.

	Code	Standard Pack	Standard weight in kg	Standard volume in m ³
With fixing plates (including gaskets, screws and wall plugs).	00056	1	2.09	0.01

Equipotential anchor



DESCRIPTION

The aim of this accessory for ladders is to solve the problem of not having the possibility to connect ground earth cable to ladders that do not have an anchoring on the pool beach.

It is mandatory by norms to connect metallic ladders to ground earth in order to have proper electrical connections. Moreover, it is highly recommended to avoid corrosion.

Equipotential anchor for ladders, manufactured in AISI-304L stainless steel and commercialized for concrete and liner pools. The anchors are composed of a recessed base on the ground, washer, screws and the equipotential bonding.

Each ladder needs to 2 units.

	Code	Standard Pack	Standard weight in kg	Standard volume in m ³
Concrete pools	73318	1	0.45	0.002
Liner pools	73319	1	0.50	0.002

Disabled access

Pal and Pal II portable chairs for disabled



DESCRIPTION

- Portable chair for disabled.
- No assembly required in pool deck area.
- The rechargeable 24V battery powers a mechanical actuator, ensuring that the chair is already ready for use. 30-Cycle duration once charged.
- The perfect solution for facilities with multiple pools as it can be set up anywhere along the pool deck and put away when not in use.
- Waterproof remote control.
- Easy to use, even for the end user. Just roll the chair to the edge of the pool, lock the wheels, set the stabilizers, and it is ready to use.
- Structure made of waterproof materials to prevent corrosion.
- Armrest and footrest included.
- The Pal makes any pool accessible in seconds. It is truly the easiest way to get everyone into the water.

	Code	Standard Pack	Standard weight in kg	Standard volume in m ³
PAL II chair.				
Counterweight in cement blocks.	69444	1	-	-

* Ask your AstralPool distributor about infinity pools, spas and other non-standard models.



Splash semi-portable lifting system for disabled people



DESCRIPTION

- Semi-portable chair installed on the pool deck for disabled people.
- Includes a cart to carry the chair in order to install it in different locations.
- Installation requires a ground anchor. Its 24 V rechargeable battery supplies power to a metallic actuator, ensuring that the device is always ready for use.
- Duration of 30 cycles once loaded.
- Waterproof remote control.
- The Splash is equipped with a water resistant structure to prevent corrosion and it has armrests and a footrest.
- Its load capacity of 136 kg and its 359° swivel makes it one of the most practical solutions for disabled access to the pool.

	Code	Standard Pack	Standard weight in kg	Standard volume in m ³
Splash Chair	53924	1	390	1.789



Disabled access

Hydraulic lift



Min. swimming pool depth:
1 m

DESCRIPTION

- It is made up of a structure made of polished Ø 43 mm AISI-316L stainless steel pipes to which the hydraulic mechanism supporting the chair is fitted.
- For the hydraulic mechanism to work there needs to be a water supply with a minimum pressure of 3.5 kg/cm².

	Code	Standard Pack	Standard weight in kg	Standard volume in m ³
Fully equipped lift				
with a 650-mm-long handrail	71657	1	-	-
with a 1000-mm-long handrail	71658	1	-	-
Optional:				
Headrest	71185	1	-	-
Foot rests	71186	1	-	-

INSTALLATION:

The external attachment is by means of two fixed metallic anchors (supplied with the device) and two adjustable front supports, which make it possible to adjust the lift to the finishes of different swimming pools.

To make it easier for people that require a hydraulic lift chair to get in and out of leisure or hydrotherapy pools. Easy to assemble.

Hydraulic lift



Min. swimming pool depth:
1.5 m

For pools shallower than 1.5 m please ask your dealer.

DESCRIPTION

- It is made up of a structure made of polished Ø 43 mm AISI-316L stainless steel pipes to which the hydraulic mechanism supporting the chair is fitted, and a ladder at the side for the assistant.
- For the hydraulic mechanism to work there needs to be a water supply with a minimum pressure of 3.5 kg/cm².

	Code	Standard Pack	Standard weight in kg	Standard volume in m ³
L-650 Railings	28619	1	18.7	0.253
L-1000 Railings	28620	1	35.5	0.383
Cylinder	28621	1	13.8	0.042
Accessories	28622	1	18.3	0.178

INSTALLATION:

The external attachment is by means of two fixed metallic anchors (supplied with the device) and two adjustable front supports, which make it possible to adjust the lift to the finishes of different swimming pools.

To make it easier for people that require a hydraulic lift chair to get in and out of leisure or hydrotherapy pools. Easy to assemble.

Disabled access

500 mm width model



DESCRIPTION

Made of polished Ø 43 mm AISI-316L stainless steel pipes. Plastic non-slip steps. Supplied with anchoring fixtures and earth connection.

	Code	Standard Pack	Standard weight in kg	Standard volume in m ³
4 steps	00116	1	28.0	0.300
5 steps	00117	1	40.9	0.300
6 steps	00118	1	47.5	0.370
7 steps	00119	1	51.4	0.370
8 steps	00120	1	48.0	1.057

970 mm width model



DESCRIPTION

Made of polished Ø 43 mm AISI-316L stainless steel pipes. Plastic non-slip steps. Supplied with anchoring fixtures and earth connection.

	Code	Standard Pack	Standard weight in kg	Standard volume in m ³
4 steps	00116 + 4 Kit 28615	1	-	-
5 steps	00117 + 5 Kit 28615	1	-	-
6 steps	00118 + 6 Kit 28615	1	-	-
7 steps	00119 + 7 Kit 28615	1	-	-
8 steps	00120 + 8 Kit 28615	1	-	-

We also supply the pipes and components needed to install grab rails or other decorative features around the edge of pools.

Step kit for converting

a ladder's width from 500 to 970 mm



DESCRIPTION

To convert the ladder from 500 mm to 970 mm, one "Step kit" is required for each of the steps of the ladder. It is made of polished AISI-316L stainless steel pipes, with plastic non-slip steps.

	Code	Standard Pack	Standard weight in kg	Standard volume in m ³
Step kit	28615	1	5.9	0.027

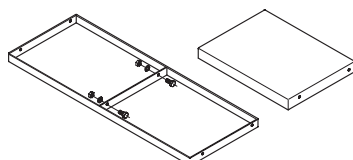

Handrails

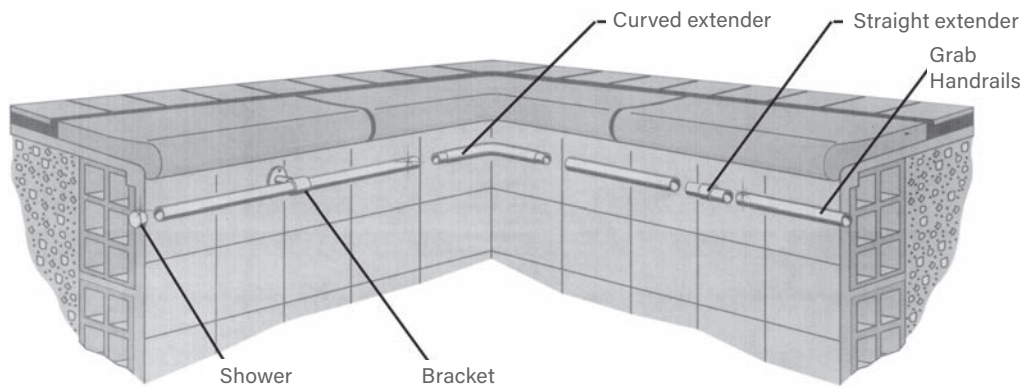

POOL SURROUND EQUIPMENT

Straight handrails



DESCRIPTION

In polished AISI-316L stainless steel pipe (Ø 43 mm). The length required must be ordered.

	Code	Standard Pack	Standard weight in kg	Standard volume in m ³
With sealed ends	05545	1	1.5	0.002
With open ends	19946	1	1.3	0.002
With one end sealed and the other open	20092	1	1.3	0.002

Straight handrail connector



DESCRIPTION

Made of polished AISI-316L stainless steel. For joining Ø 43 mm stainless steel pipes.

	Code	Standard Pack	Standard weight in kg	Standard volume in m ³
Straight handrail connector	09452	1	0.32	0.001

Curved connector



DESCRIPTION

Made of polished AISI-316L stainless steel. For joining Ø 43 mm pipes.

	Code	Standard Pack	Standard weight in kg	Standard volume in m ³
Curved connector	11286	1	0.3	0.001

End Caps



DESCRIPTION

For the end of Ø 43 mm handrail pipes. Made of polished AISI-316L stainless steel.

	Code	Standard Pack	Standard weight in kg	Standard volume in m ³
End cap	08014	1	0.1	0.001

Handrails attachment support

Bracket closed at one end



DESCRIPTION

Made of AISI-316L stainless steel for Ø 43 mm handrails. Supplied with screws, gasket and wall plugs.

	Code	Standard Pack	Standard weight in kg	Standard volume in m ³
Bracket closed at one end	07789	2	0.6	0.002

90° Angle handrail support



DESCRIPTION

Made of AISI-316L stainless steel for Ø 43 mm handrails. Supplied with screws, gasket and wall plugs.

	Code	Standard Pack	Standard weight in kg	Standard volume in m ³
90° Angle handrail support	11143	1	1.17	0.002

Adaptor kit for liner swimming pools



DESCRIPTION

Made of AISI-316L stainless steel.

	Code	Standard Pack	Standard weight in kg	Standard volume in m ³
Adaptor kit for liner swimming pools	26172	1	0.3	0.002

Split bracket



DESCRIPTION

For Ø 43 mm pipe. Made of polished AISI-316L stainless steel. Supplied with screws and wall plugs (concrete swimming pools) and gasket and screws (liner swimming pools).

	Code	Standard Pack	Standard weight in kg	Standard volume in m ³
Concrete swimming pool	25342	2	0.72	0.002
Liner swimming pool	28618	2	1.40	0.002

Straight bracket with base plate



DESCRIPTION

Made of AISI-316L polished stainless steel for Ø 43 mm handrails. Supplied with screws, gasket and wall plugs.

	Code	Standard Pack	Standard weight in kg	Standard volume in m ³
Straight bracket with base plate	08013	2	0.5	0.002

Lifeguard chairs

Lifeguard chair



DESCRIPTION

Made with polished Ø 43 mm AISI-304L stainless steel pipes. The steps, platform and chair are made of plastic. The base bar has wheels.

	Code	Standard Pack	Standard weight in kg	Standard volume in m ³
Lifeguard chair	56993	1	55.6	0.52
Lifebuoy holder	56994	1	0.6	0.03
Sunshade bracket	56995	1	0.6	0.01



56994

56995

H-400 quick access lifeguard chair



DESCRIPTION

Made of polished Ø 43 mm AISI-304L stainless steel pipes. The steps, platform and chair are made of plastic. Large platform and 90° rotating seat to increase the range of vision. Ideal for children's or paddling pools.

Includes bracket for sunshade.

	Code	Standard Pack	Standard weight in kg	Standard volume in m ³
H-400 lifeguard chair	15673	1	39.6	0.66

Multipurpose H-1000 lifeguard chair



DESCRIPTION

Made of polished Ø 43 mm AISI-304L stainless steel pipes. The steps, platform and chair are made of plastic. Large platform and 90° rotating seat to increase the range of vision. Includes bracket for sunshade.

	Code	Standard Pack	Standard weight in kg	Standard volume in m ³
H-1000 lifeguard chair	15674	1	65.0	1.64

Life-saving accessories

Lifebuoy holder



DESCRIPTION

Made of AISI-316L stainless steel with connection to telescopic handles 01361, 01362, 01363 and 15838 by means of wing nuts.

	Code	Standard Pack	Standard weight in kg	Standard volume in m ³
Lifebuoy holder	01368	1	1.46	0.03

Lifebuoy



DESCRIPTION

Made of Styropor covered with orange canvas, Ø 700 mm.

	Code	Standard Pack	Standard weight in kg	Standard volume in m ³
Lifebuoy	01369	6	18.0	0.330

Lifebuoy holder



DESCRIPTION

Made of polished AISI-304L stainless steel. It can be hung on the wall or fitted to a lifebelt holder post (code 01371). It is supplied with wall plugs and screws.

	Code	Standard Pack	Standard weight in kg	Standard volume in m ³
Lifebuoy holder	01370	1	1.16	0.004

Lifebelt holder post



DESCRIPTION

In polished AISI-316L stainless steel (Ø 43 mm). Baseplate with 3 holed. Supplied with flexible seal, wall plugs and screws.

	Code	Standard Pack	Standard weight in kg	Standard volume in m ³
Lifebelt holder post	01371	1	3.0	0.01

SHOWERS

Showers with timers

Shower with timer and 4 shower heads



DESCRIPTION

AISI-304L polished stainless steel shower, specially designed for high footfall facilities (public or semi-public pools). AstralPool showers for public facilities are characterised by their highly resistant materials, considered vandal-proof, and the water savings made thanks to their built-in flow limiters. Showerhead height from floor: 2 m. Fastened to floor with screws, with anchoring fixture incorporated. Fastens to ground with screws and includes an anchoring fixture.

	Code	Standard Pack	Standard weight in kg	Standard volume in m ³
Shower with timer and 4 shower heads	59779	1	18.7	0.166



SHOWERHEADS



TIMER SWITCHES

SHOWERS

Showers tunnels

Shower tunnel with arch



DESCRIPTION

For swimming pool entrances. Made of polished AISI-304L stainless steel pipe with a diameter of 28 mm. Supplied with wall plugs and screws.

	Code	Standard Pack	Standard weight in kg	Standard volume in m ³
1 Arch				
with 3 shower heads. Width 1.2 m.	00100	1	9,6	0.10
with 5 shower heads. Width 2 m.	19948	1	10.4	0.14



SHOWERHEAD

Shower tunnels

Control column



DESCRIPTION

Made of AISI-304L stainless steel. The control the automatic opening and closing of the water circuit. It includes the following elements: a 220V/24V transformer, a photoelectric timer cell and an electro valve. It is supplied with wall plugs and screws.

	Code	Standard Pack	Standard weight in kg	Standard volume in m ³
Control column	00102	1	7.0	0.02

Outdoor footbaths

Footwash for public use



DESCRIPTION

Footwash tray measuring 2 x 1 m, for public use. Made of polyester resin and fibreglass. Finished with Gelcoat. Specifications:

- Drain grille 3/8"
- Overflow and water inlet connection 3/8".
- Non-slip surface incorporated in the polyester.
- Angled tray to avoid water build-up.

	Code	Standard Pack	Standard weight in kg	Standard volume in m ³
Blue colour	21255	1	30.0	0.91
White colour	21255CLO7	1	30.0	0.91

Dosing recipient



DESCRIPTION

Designed to be installed in the footwash (screwed or glued) as a recipient for a 200 g Chlorine tablet that dissolves gradually and disinfects the water. Includes locking screws to prevent undue opening as well as for ensuring user safety.

	Code	Standard Pack	Standard weight in kg	Standard volume in m ³
Dosing recipient	25356	-	-	-

Water curtains

NOTE: The water features do not include a pump, control box or suction pipes.

- Range of cascades for residential pools made of AISI-316L stainless steel.
- The range is made up of three cascades in an outstanding modern design.
- Polished + matt finish.
- All models come with anchoring. A ½ HP pump is recommended (code 65557).



Classic water curtain



	Code	Standard Pack	Standard weight in kg	Standard volume in m ³
Classic water curtain	57095	1	28	0.38



Straight water curtain



	Code	Standard Pack	Standard weight in kg	Standard volume in m ³
Straight water curtain	57096	1	36	0.25



One water curtain



	Code	Standard Pack	Standard weight in kg	Standard volume in m ³
One water curtain	57097	1	36	0.25



RECOMMENDED

Victoria Plus Silent pump

See P.202



Residential water curtain



DESCRIPTION

Residential water curtain in polished stainless steel. Fastened to the ground with screws and anchor studs.

	Code	Standard Pack	Standard weight in kg	Standard volume in m ³
In AISI-316L stainless steel				
A-350 - 12 m ³ /h, 2 mca	52244	1	10	0.12
A-500 - 18 m ³ /h, 2 mca	52245	1	15	0.24

NOTE: The water features do not include a pump, control box or suction pipes.

TECHNICAL FEATURES

Code	Suction concrete	Pump	Control box	*Optional Push button + Switch
52244	00302 x 2	65560	25719	04047 + 04050
52245	00302 x 2	65562	25719	04047 + 04050

* Optional: components for turning the waterfall on from the pool.

NOTE: The water features do not include anchoring, pump, control panel nor suction system.

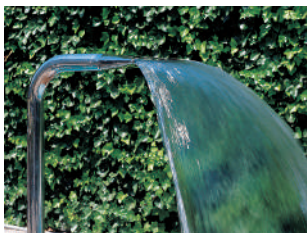

Water curtains

Cobra Curtain



DESCRIPTION

Height: 1.2 m. Width 600 mm. AISI-316L stainless steel.

	Code	Standard Pack	Standard weight in kg	Standard volume in m ³
Matt finish	19972	1	23.2	0.630
Painted in white	19973	1	23.2	0.630



Boa Curtain



DESCRIPTION

Height: 1.2 m. Width 340 mm. AISI-316L stainless steel.

	Code	Standard Pack	Standard weight in kg	Standard volume in m ³
Bright polished	19974	1	11.2	0.278



Luxe Curtain



DESCRIPTION

Height: 0.9 m. AISI-316L stainless steel.

	Code	Standard Pack	Standard weight in kg	Standard volume in m ³
Bright polished	19975	1	60.0	0.547



Arched Curtain



DESCRIPTION

AISI-316L stainless steel matt finish.

	Code	Standard Pack	Standard weight in kg	Standard volume in m ³
Width 600 mm, Height 800 mm	20129	1	34.1	0.247
Width 600 mm, Height 1000 mm	20130	1	62.0	0.547
Width 1000 mm, Height 1000 mm	20131	1	106.5	1.044

Water curtains

NOTE: The water features do not include anchoring, pump, control panel nor suction system.

Cobra, Boa, Luxe, Arched curtains



19972-19973

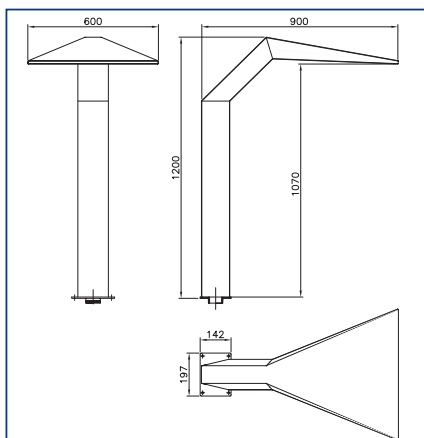

19974

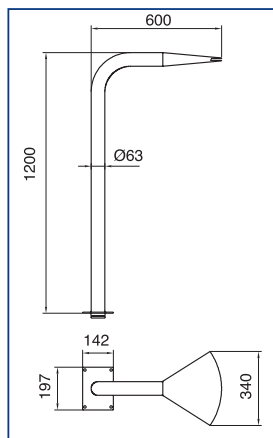

19975

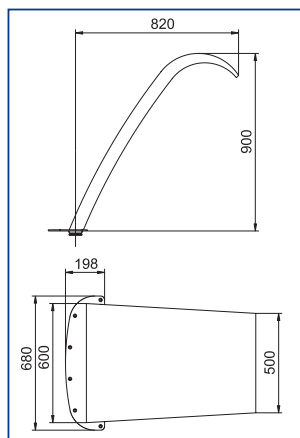

20129

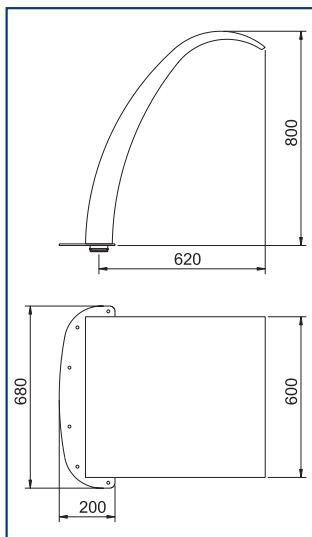

20130

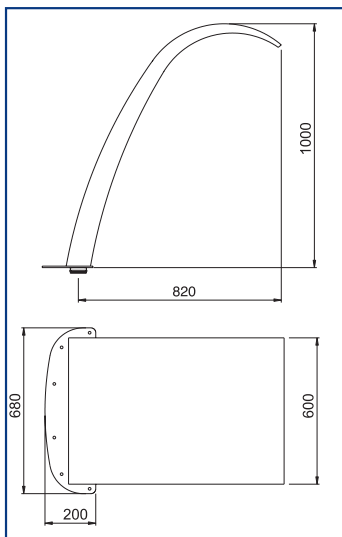

20131

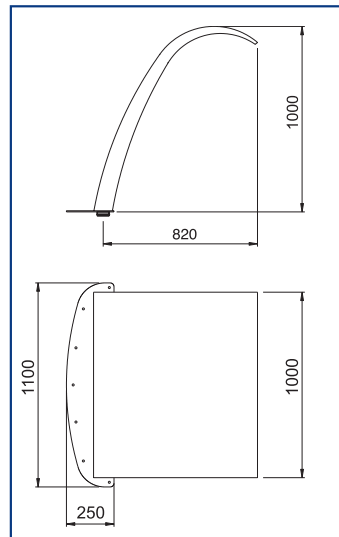

TECHNICAL FEATURES

Curtain code	Faceplate	Anchoring sockets		Suction		Pump	Control box	
		Concrete	Concrete	Liner	Manual push button		Pneumatic push button	
							Concrete	Liner
19972	19981	19983	19987 x 3	20091 x 3	65570	19990	07537	07867
19973	19982	19983	19987 x 3	20091 x 3	65570	19990	07537	07867
19974	19977	19983	19987 x 2	20091 x 2	65565	19989	17154	17155
19975	-	19985	19987 x 3	20091 x 3	65570	19990	07537	07867
20129	-	19985	19987 x 3	20091 x 3	65570	19990	07537	07867
20130	-	19985	19987 x 3	20091 x 3	65570	19990	07537	07867
20131	-	20135	19987 x 3	20091 x 3	65570	19990	07537	07867

Note: The pneumatic push button includes: control box, wall conduits and push button.

NOTE: The water features do not include anchoring, pump, control panel nor suction system.

Water curtains

Swan Curtain 450

DESCRIPTION

In AISI-316L stainless steel.

	Code	Standard Pack	Standard weight in kg	Standard volume in m ³
Matt finish	34387	1	27.7	0.356

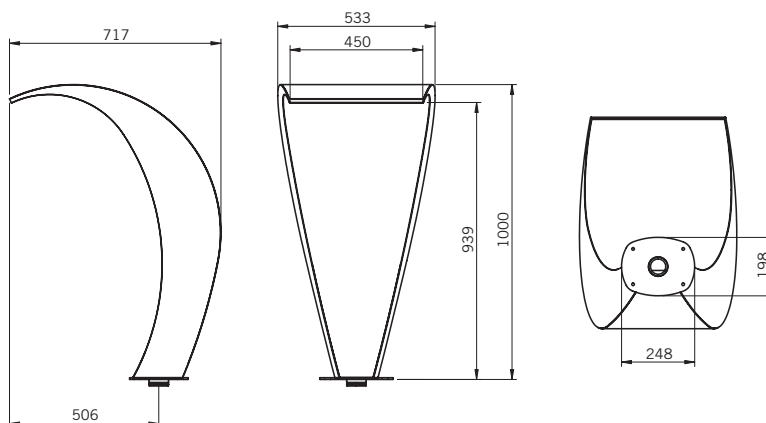

Swan Curtain 1000

DESCRIPTION

In AISI-316L stainless steel.

	Code	Standard Pack	Standard weight in kg	Standard volume in m ³
Matt finish	34390	1	38.2	0.872

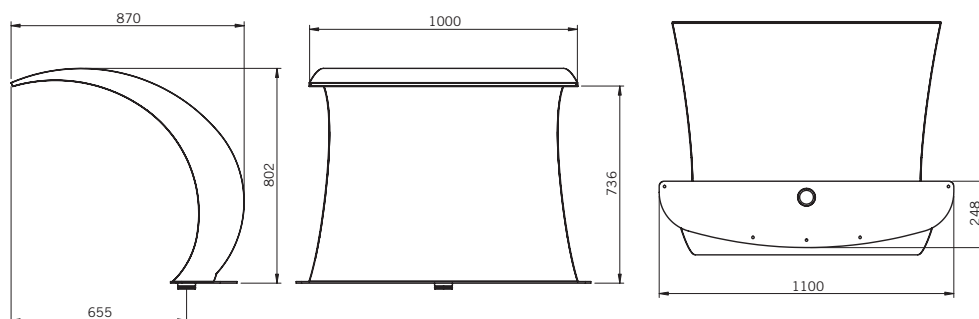
TECHNICAL FEATURES

Curtain code	Anchoring sockets		Suction		Pump	Control box		
	Concrete	Concrete	Concrete	Liner		Manual push button	Pneumatic push button	
							Concrete	Liner
34387	19983	19987 x 2	20091 x 2	65565	19989	17154	17155	
34390	20135	19987 x 3	20091 x 3	65570	19990	07537	07867	

Note: The pneumatic push button includes: control box, wall conduits and push button.

NOTE: The water features do not include anchoring, pump, control panel nor suction system.

Water cannons

Cannons



DESCRIPTION

In AISI-316L polished stainless steel (cannon only, no nozzles) Ø 50mm pipe. Height 1.2 m.

	Code	Standard Pack	Standard weight in kg	Standard volume in m ³
Cannon	19968	1	7.2	0.193

Interchangeable nozzles



	Code	Standard Pack	Standard weight in kg	Standard volume in m ³
Nozzle No 1	05572	1	0.66	0.003
Nozzle No 2	05573	1	0.46	0.003
Nozzle No 3	05574	1	0.56	0.003
Nozzle No 4	05575	1	0.81	0.003

Vertical



DESCRIPTION

In polished AISI-316L Stainless Steel. Pipe: Ø 84 mm. Height 1.5 m.

	Code	Standard Pack	Standard weight in kg	Standard volume in m ³
Single	19969	1	10	0.080

NOTE: The water features do not include anchoring, pump, control panel nor suction system.



52242

52243

NOTE: The water features do not include a pump, control box or suction pipes.

NOTE: The water features do not include anchoring, pump, control panel nor suction system.

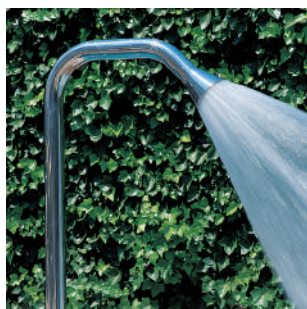

WATER GAMES AND ORNAMENTAL WATER FEATURES

Water cannons

Residential water cannon

DESCRIPTION

Residential water cannon in polished stainless steel. Fastened to the ground with screws and anchor studs.

	Code	Standard Pack	Standard weight in kg	Standard volume in m ³
AISI-316L stainless steel				
Round opening. 5 m ³ /h, 2 mca	52242	1	3	0.12
Flat opening. 15 m ³ /h, 2 mca	52243	1	5	0.13
AISI-304L stainless steel				
Round opening. 5 m ³ /h, 2 mca	52238	1	3	0.12
Flat opening. 15 m ³ /h, 2 mca	52239	1	5	0.13

TECHNICAL FEATURES

Code	Suction concrete	Pump	Control box	*Optional Push button + Switch
52242	00302	65557	25718	04047 + 04050
52243	00302 x 2	65560	25719	04047 + 04050
52238	00302	65557	25718	04047 + 04050
52239	00302 x 2	65560	25719	04047 + 04050

*Optional: components for turning the cannon on from the pool.

Bell

DESCRIPTION

In AISI-316L stainless steel. Pipe: Ø 63 mm. Height 1.2 m.

	Code	Standard Pack	Standard weight in kg	Standard volume in m ³
Bell	19971	1	9.2	0.274

NOTE: The water features do not include anchoring, pump, control panel nor suction system.

Water cannons

Deluxe Cannon



DESCRIPTION

Stainless Steel polished AISI-316L. Pipe: Ø 63 mm. Height: 0.8 mm.

	Code	Standard Pack	Standard weight in kg	Standard volume in m ³
Flat	19970	1	8.2	0.211
Circular	20132	1	9.4	0.209
6 outlets	20133	1	8.6	0.213

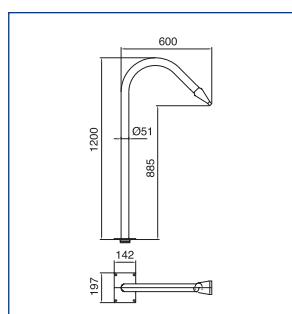

19968

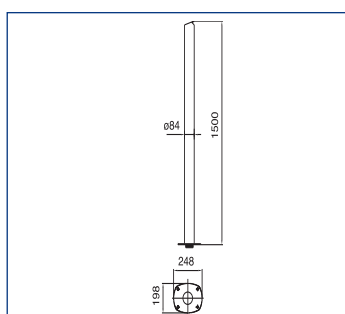

19969

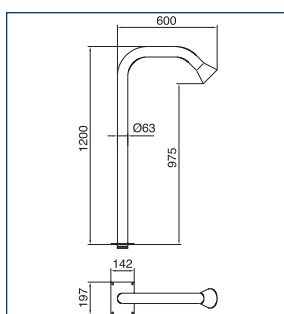

19971

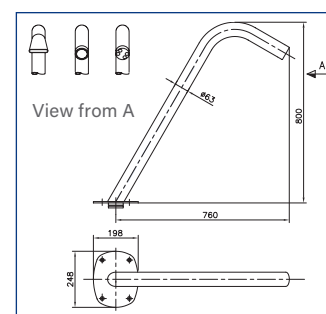

19970-20132-20133

TECHNICAL FEATURES

Code water feature	Face plate	Anchoring sockets		Suction		Pump	Control box	
		Concrete	Concrete	Liner	Manual push button		Pneumatic push button	
							Concrete	Liner
19968	19976	19983	19987 x 1	20091 x 1	65558	19988	07669	07868
19969	19978	19983	19987 x 1	20091 x 1	65558	19988	07669	07868
19970	-	19983	19987 x 1	20091 x 1	65558	19988	07669	07868
19971	19977	19983	19987 x 2	20091 x 2	65565	19989	17154	17155
20132	-	19983	19987 x 1	20091 x 1	65558	19988	07669	07868
20133	-	19983	19987 x 1	20091 x 1	65558	19988	07669	07868

Note: The pneumatic push button includes: control box, wall conduits and push button.

Waterfalls

Ornamental waterfalls



NOTE: The water features do not include a pump, control box or suction pipes.

DESCRIPTION

In AISI-316L stainless steel.

	Code	Standard Pack	Standard weight in kg	Standard volume in m ³
Width (W) 300 mm, 1½" connection (B)	05577	1	6.9	0.06
Width (W) 600 mm, 2" connection (B)	05578	1	11.9	0.09

TECHNICAL FEATURES

Water feature code	Face plate	Anchoring sockets		Suction		Pump	Control box		
		Concrete	Liner	Concrete	Liner		Manual push button	Pneumatic push button	
								Concrete	Liner
05577	-	-	-	19987 x 1	20091 x 1	65558	19988	07669	07868
05578	-	-	-	19987 x 2	20091 x 2	65565	19989	17154	17155

Note: The pneumatic push button includes: control box, wall conduits and push button.

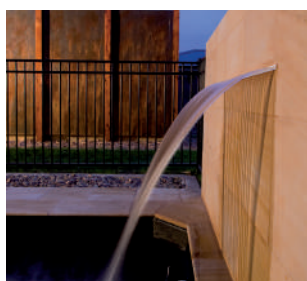

SilkFlow waterfalls

DESCRIPTION

Waterfall made of corrosion resistant ABS. Can be fed through the return circuit of the pool filter or through a specific pump.

	Code	Standard Pack	Standard weight in kg	Standard volume in m ³
300 mm waterfall	45205	1	1.19	0.012
600 mm waterfall	45206	1	2.36	0.021
900 mm waterfall	45207	1	3.45	0.003
1200 mm waterfall	45208	1	4.62	0.004
1800 mm waterfall	54090	1	7.0	0.057

NOTE: The water features do not include a pump, control box or suction pipes.

TECHNICAL FEATURES

Code	Required water flow l/min	Standard pump size HP	A Length of waterfall	B Width of waterfall over the pool surface, at the recommended rate of l/min/m	C Recommended height for the waterfall	D Distance of the water at the recommended rate of l/min/m
45205	50	0,5	300 mm	200 mm	300 mm	300 mm
45206	100	0,5	600 mm	500 mm	600 mm	300 mm
45207	150	0,75	900 mm	800 mm	900 mm	300 mm
45208	200	0,75	1200 mm	1100 mm	900 mm	300 mm
54090	300	1,50	1800 mm	1700 mm	900 mm	300 mm

NOTE: The water features do not include anchoring, pump, control panel nor suction system.

Umbrellas

Umbrellas



DESCRIPTION

In AISI-316L Stainless Steel polished column. Umbrella in polyester.

	Code	Standard Pack	Standard weight in kg	Standard volume in m ³
Umbrella S, Ø 1100 mm	22750	1	30.0	0.450
Umbrella M, Ø 1500 mm	22751	1	85.0	1.900
Umbrella L, Ø 2000 mm	22752	1	110.0	2.400
Umbrella XL, Ø 2500 mm	22753	1	130.0	3.500
Column Ø 129 mm	22754	1	23.4	0.274
Column Ø 254 mm	22755	1	55.8	0.507

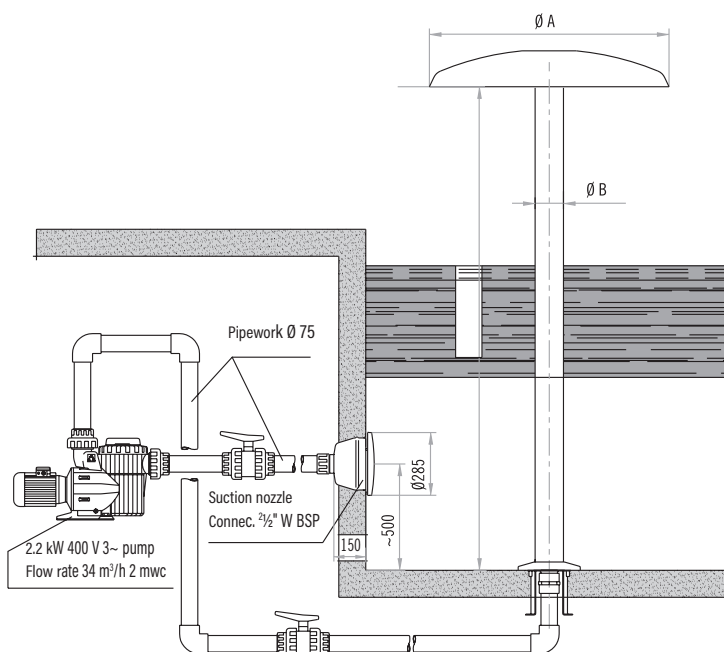
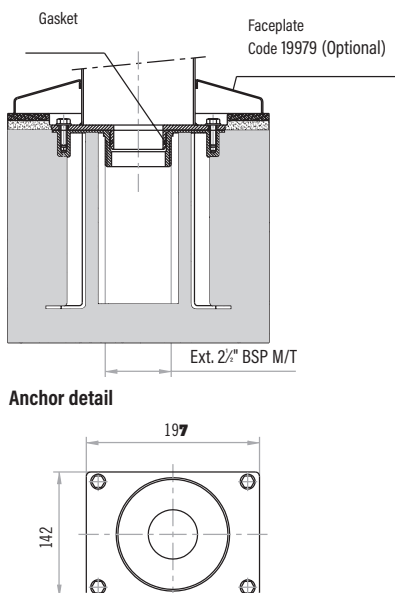

TECHNICAL FEATURES

Parasol Ø	Canopy	Column	Face plate	Anchoring sockets		Suction		Pump	Control box		
				Concrete	Liner	Concrete	Liner		Manual push button	Pneumatic push button	
										Concrete	Liner
1100	22750	22754	19979	19983	15833	19987 x 3	20091 x 3	65570	19990	07537	07867
1500	22751	22755	19980	19984	19986	19987 x 4	20091 x 4	08003	19991	-	-
2000	22752	22755	19980	19984	19986	19987 x 4	20091 x 4	08003	19991	-	-
2500	22753	22755	19980	19984	19986	19987 x 5	20091 x 5	08004	19992	-	-

Note: The pneumatic push button includes: control box, wall conduits and push button.

NOTE: The water features do not include anchoring, pump, control panel nor suction system.

Water mushrooms

Mushrooms



DESCRIPTION

In AISI-316L polished stainless steel. Column Ø 129 mm. Height 2.3 m.

	Code	Standard Pack	Standard weight in kg	Standard volume in m ³
Mushroom Ø 285 mm	19966	1	24.8	0.273

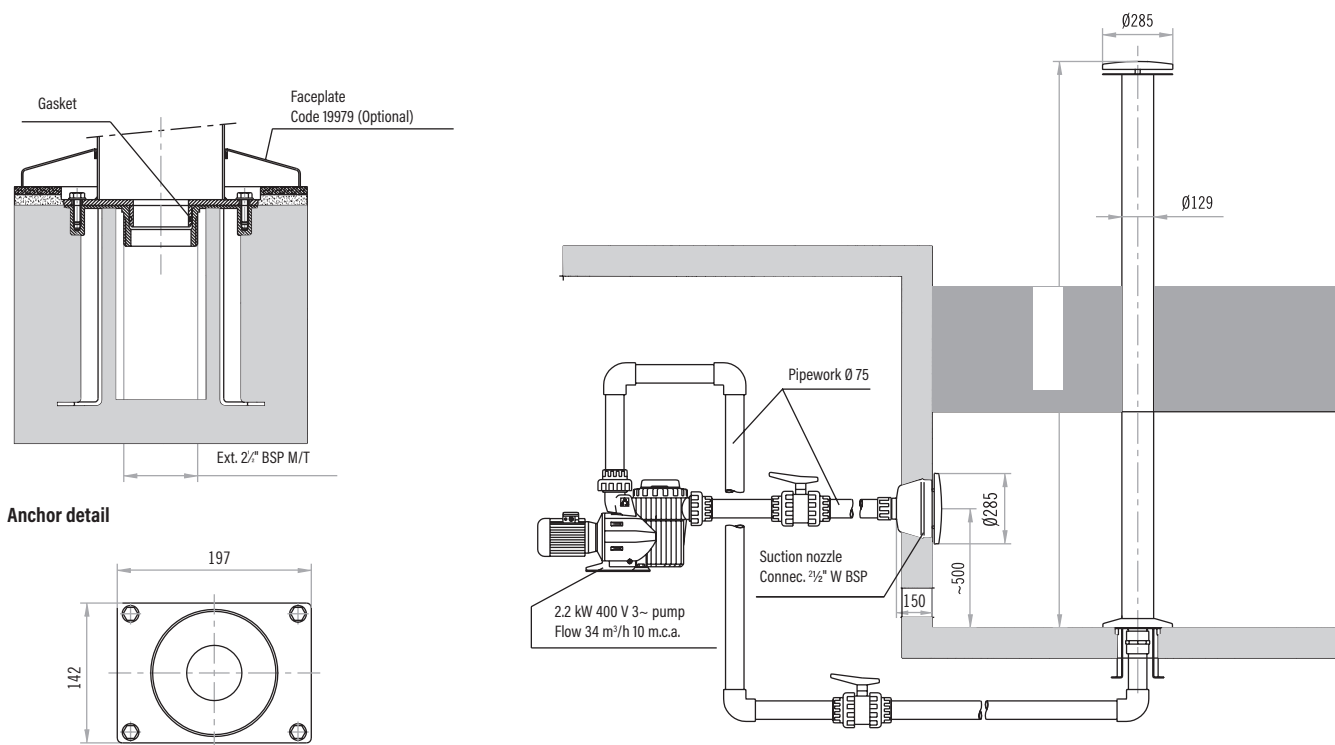

TECHNICAL FEATURES

Code water feature	Face plate	Anchoring sockets		Suction		Pump	Control box		
		Concrete	Liner	Concrete	Liner		Manual push button	Pneumatic push button	
								Concrete	Liner
19966	19979	19983	15833	19987 x 3	20091 x 3	65570	19990	07537	07867

Note: The pneumatic push button includes: control box, wall conduits and push button.

NOTE: The water features do not include anchoring, pump, control panel nor suction system.

Water mushrooms

Water Mushroom Ø 250 mm



DESCRIPTION

In AISI-316L stainless steel. Its fastening system allows it to be fitted in concrete or prefabricated pools. Column Ø 104 mm. Height 385 mm.

	Code	Standard Pack	Standard weight in kg	Standard volume in m ³
Matt finish	34378	1	5.4	0.34



Water Mushroom Ø 400 mm



DESCRIPTION

Made of AISI-316L. It has been designed for installing in prefab. and concrete pools. Column Ø 129 mm. Height 460 mm.

	Code	Standard Pack	Standard weight in kg	Standard volume in m ³
Matt finish	34381	1	9.6	0.124



Water Mushroom Ø 670 mm



DESCRIPTION

Made of AISI-316L. It has been designed for installing in prefab. and concrete pools. Column Ø 168 mm. Height 600 mm.

	Code	Standard Pack	Standard weight in kg	Standard volume in m ³
Matt finish	34384	1	24.5	0.377

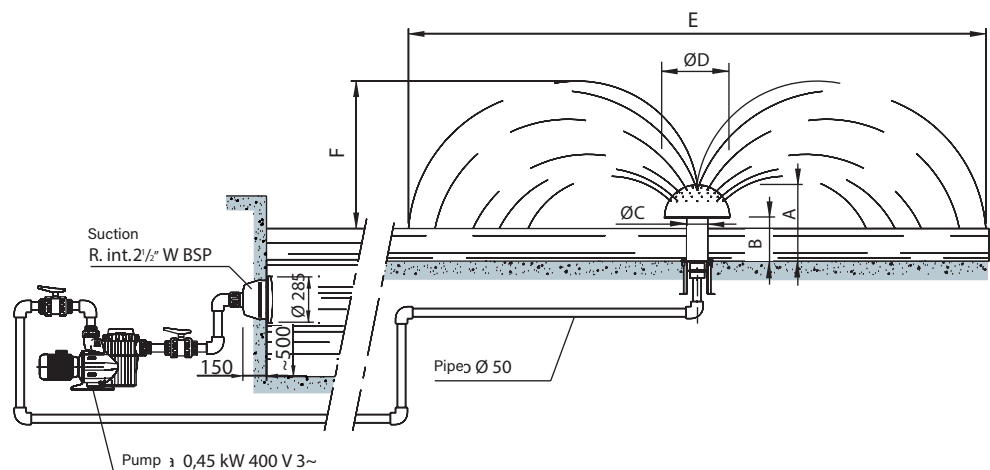

TECHNICAL FEATURES

Mushroom Ø	Size in cm					Feature code	Anchoring sockets		Suction		Pump	Control box		
	A	B	Ø C	E	F		Concrete	Liner	Concrete	Liner		Manual push button	Pneumatic push button	
													Concrete	Liner
250	385		104	5000	1500	34378								
400	460	270	129	6600	1700	34381	19983	15833	19987x1	20091x1	65558	19988	07669	07868
670	600		168	7000	1800	34384								

Note: The pneumatic push button includes: control box, wall conduits and push button.

NOTE: The water features do not include anchoring, pump, control panel nor suction system.

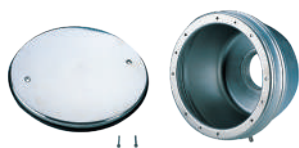

Water features accessories

Concrete pool wall suction point



DESCRIPTION

In AISI-316L Stainless Steel. Ø 285 mm. Suction point for water features. Connection 2½". Max. Recommended flow: 13 m³/h.

	Code	Standard Pack	Standard weight in kg	Standard volume in m³
Concrete swimming pool	19987	1	2.9	0.018



Prefabricated and liner pool wall suction point



DESCRIPTION

In AISI-316L Stainless Steel. Ø 285 mm. Suction point for water features. Connection 2½". Max. Recommended flow: 13 m³/h.

	Code	Standard Pack	Standard weight in kg	Standard volume in m³
Prefabricated and liner pool	20091	1	2.9	0.018



19983

Anchoring for liner pools



DESCRIPTION

In AISI-316L Stainless Steel. Includes base for embedding, fixing plate, gaskets and earth connection. Connection 2½".

	Code	Standard Pack	Standard weight in kg	Standard volume in m³
Rectangular anchoring	19983	1	2.1	0.012
Ø 254 mm anchoring	19984	1	9.8	0.113
600 mm wide anchoring	19985	1	6.4	0.039
1000 mm wide anchoring	20135	1	10.8	0.076



15833

Anchoring for liner pools



DESCRIPTION

In AISI-316L Stainless Steel. Includes base for embedding, fixing plate, 3 gaskets and earth connection. Connection 2½".

	Code	Standard Pack	Standard weight in kg	Standard volume in m³
Rectangular anchoring	15833	1	2.5	0.007
Ø 254 mm anchoring	19986	1	11.0	0.400



19986

NOTE: The water features do not include anchoring, pump, control panel nor suction system.

Water features accessories

Base cover



DESCRIPTION

In polished AISI-316L stainless steel.

	Code	Standard Pack	Standard weight in kg	Standard volume in m ³
Ø 51 mm	19976	1	1.0	0.008

Base cover



DESCRIPTION

In polished AISI-316L stainless steel.

	Code	Standard Pack	Standard weight in kg	Standard volume in m ³
Ø 63 mm	19977	1	1.0	0.008

Base cover



DESCRIPTION

In polished AISI-316L stainless steel.

	Code	Standard Pack	Standard weight in kg	Standard volume in m ³
Ø 84 mm	19978	1	0.9	0.006

Base cover



DESCRIPTION

In polished AISI-316L stainless steel.

	Code	Standard Pack	Standard weight in kg	Standard volume in m ³
Ø 129 mm	19979	1	0.9	0.005

Base cover



DESCRIPTION

In polished AISI-316L stainless steel.

	Code	Standard Pack	Standard weight in kg	Standard volume in m ³
Ø 254 mm	19980	1	0.9	0.006

NOTE: The water features do not include anchoring, pump, control panel nor suction system.

Water features accessories

Base cover



	Code	Standard Pack	Standard weight in kg	Standard volume in m ³
600 mm curtain. Matt finish	19981	1	1.22	0.008



Base cover



	Code	Standard Pack	Standard weight in kg	Standard volume in m ³
600 mm curtain. Painted	19982	1	1.28	0.008

Control box - Manual



	Code	Standard Pack	Standard weight in kg	Standard volume in m ³
Manual - control box				
0.45 kW (0.5 HP) 400 V III	19988	1	0.7	0.005
1.1 kW (1.5 HP) 400 V III	19989	1	0.7	0.005
2.2 kW (3.0 HP) 400 V III	19990	1	0.7	0.005
2.65 kW (3.5 HP) 400 V III	19991	1	0.7	0.005

Control box pneumatic switch



DESCRIPTION

Enables bathers to control water features from inside the pool. Includes control box, wall conduit, air pipe and pneumatic switch.

	Code	Standard Pack	Standard weight in kg	Standard volume in m ³
For concrete pool				
2.2 kW (3.0 HP) 400 V III	07537	1	3.1	0.02
0.45 kW (0.5 HP) 400 V III	07669	1	3.1	0.02
1.1 kW (1.5 HP) 400 V III	17154	1	3.1	0.02
For prefabricated pools				
2.2 kW (3.0 HP) 400 V III	07867	1	3.2	0.02
0.45 kW (0.5 HP) 400 V III	07868	1	3.2	0.02
1.1 kW (1.5 HP) 400 V III	17155	1	3.2	0.02

All products must be installed at a depth of 30-40 cm. See the technical specifications on the following pages.

Water games

- Water features help to create a leisure space where you can enjoy water activities in a fun, safe and physically active environment with your family.



Hydra



DESCRIPTION

- Body of polyester reinforced with fiberglass.
- Outlet nozzles made of stainless steel AISI-304L.
- Hardware made of S.S. AISI-304L.

	Code	Standard Pack	Standard weight in kg	Standard volume in m ³
Hydra	66450	1	-	-



Crux



DESCRIPTION

- Body of polyester reinforced with fiberglass.
- Outlet nozzles are made of stainless steel AISI-304L and polyacetal.
- Hardware made of S.S. AISI-304L.

	Code	Standard Pack	Standard weight in kg	Standard volume in m ³
Crux	66449	1	-	-



Corvus



DESCRIPTION

- Body of polyester reinforced with fiberglass.
- Outlet nozzles made of polyacetal (POM).
- Hardware made of S.S. AISI-304L.

	Code	Standard Pack	Standard weight in kg	Standard volume in m ³
Corvus	66451	1	-	-



All products must be installed at a depth of 30-40 cm. See the technical specifications on the following pages.

Water games

Rainbow Sunshade



DESCRIPTION

- Bodywork in polyester reinforced with fibreglass. AISI-304L stainless steel shaft.
- Outlet nozzles made of stainless steel AISI-304L.
- Hardware made of S.S. AISI-304L.

	Code	Standard Pack	Standard weight in kg	Standard volume in m ³
Rainbow Sunshade	66452	1	-	-

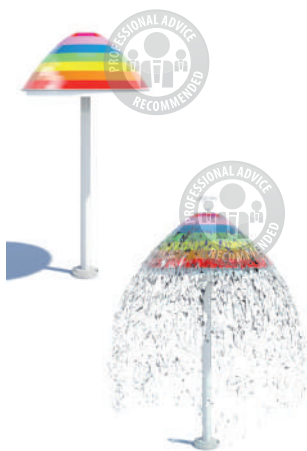

Palm



DESCRIPTION

- Shape made of polyester reinforced with fibreglass.
- Body made of stainless steel AISI-304L.
- Outlet nozzles made of polyacetal (POM).
- Hardware made of S.S. AISI-304L.

	Code	Standard Pack	Standard weight in kg	Standard volume in m ³
Palm	66453	1	-	-



Bow



DESCRIPTION

- Body made of stainless steel AISI-304L.
- Polyacetal sprinklers.
- Hardware made of stainless steel.

	Code	Standard Pack	Standard weight in kg	Standard volume in m ³
Bow	66456	1	-	-



All products must be installed at a depth of 30-40 cm. See the technical specifications on the following pages.

Water games

Lamppost

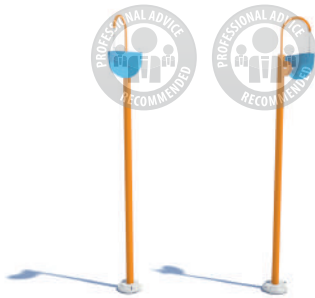

DESCRIPTION

- Baskets made of fibreglass.
- Body made of stainless steel AISI-304L.
- Outlet nozzles are made of stainless steel AISI-304L.
- Hardware made of stainless steel AISI-304L.

	Code	Standard Pack	Standard weight in kg	Standard volume in m ³
Lamppost	66454	1	-	-

Streetlight

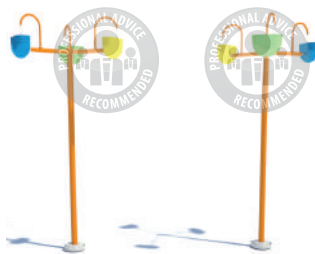

DESCRIPTION

- Shape made of polyester reinforced with fiberglass.
- Body made of stainless steel AISI-304L.
- Outlet nozzles made of stainless steel AISI-304L.
- Hardware made of stainless steel AISI-304L.

	Code	Standard Pack	Standard weight in kg	Standard volume in m ³
Streetlight	66455	1	-	-

Rainbow Mini Slide



DESCRIPTION

- Slide made of polyester reinforced with fiberglass.
- Panels made of 20 mm high density polythene.
- Hardware made of stainless steel AISI-304L.

	Code	Standard Pack	Standard weight in kg	Standard volume in m ³
Rainbow Mini Slide	66457	1	-	-

Whale Mini Slide



DESCRIPTION

- Slide made of polyester reinforced with fiberglass.
- Panels made of 20 mm high density polythene.
- Hardware made of stainless steel AISI-304L.

	Code	Standard Pack	Standard weight in kg	Standard volume in m ³
Whale Mini Slide	66458	1	-	-

Water games



Atlantic

DESCRIPTION

- Slide made of polyester reinforced with fiberglass.
- Posts made of AISI-304L stainless steel, coated in polyester paint.
- High-density 15 mm polyethylene panels.
- Outlet nozzles are made of stainless steel AISI-304L and polyacetal.
- Hardware made of stainless steel AISI-304L.

	Code	Standard Pack	Standard weight in kg	Standard volume in m ³
Atlantic	66459	1	-	-



This product must be installed at a depth of 30-40 cm.

Active



DESCRIPTION

- Slide made of polyester reinforced with fiberglass.
- Wooden posts.
- Panels made of 20 mm high density polythene.
- Handrail and fasteners made of AISI-304L stainless steel.
- Baseplates made of AISI-304L stainless steel.

	Code	Standard Pack	Standard weight in kg	Standard volume in m ³
Active	66460	1	-	-



Article to be installed at poolside at a depth of at least 110 cm.

Bubbles



DESCRIPTION

- Slide made of polyester reinforced with fiberglass.
- Posts made of AISI-304L stainless steel, coated in polyester paint.
- High-density 15 mm polyethylene panels
- Outlet nozzles made of polyacetal (POM).
- Hardware made of stainless steel AISI-304L.

	Code	Standard Pack	Standard weight in kg	Standard volume in m ³
Bubbles	66461	1	-	-



This product must be installed at a depth of 30-40 cm.

Water games

TECHNICAL FEATURES

Code	Name	Floor plan dimensions (cm)	Maximum height of water feature (cm)	Required flow rate (l/min)	Pressure (bar)
66450	Hydra	Ø 87	161.5	120	1
66449	Crux	130 x 50	140	130	1
66451	Corvus	60 x 60	163.5	47	1
66452	Sunshade Rainbow	Ø 160	289.5	400	1
66453	Palm	Ø 223	350	120	1
66456	Bow	320	160	70	1
66454	Lamppost	Ø 79	345	120	1
66455	Streetlight	Ø 198	360	360	1
66457	Rainbow Mini Slide	279 x 630	105	-	-
66458	Whale Mini Slide	276 x 660	101	-	-
66459	Atlantic	331 x 108	412	850	1
66460	Active	575 x 423	275	48	1
66461	Bubbles	660 x 582	375	400	1

READY FOR FUN?

It is a game whose main feature is the surprise factor. Children do not know when the cube is filled and overturn on them all the water it contains. It is specially designed for older children or young people.

Wave Splash bucket

DESCRIPTION

Designed and manufactured according to the standards EN-1176. It has nozzles embedded and rotating parts that avoid grips and entrapments in order to ensure maximum safety.

Used materials:

- Aisi-304L stainless steel painted with powder coating of polyester, matt finish and treaty against the heat.
- Drive nozzles made of synthetic polymer POM.
- AISI-304L stainless steel hardware vandal-proof.
- Feet protection to prevent children from damage.

	Code	Standard Pack	Standard weight in kg	Standard volume in m ³
Wave Splash bucket	IS-30A47	1	-	-

How is it installed ?

It is necessary to soak it into the concrete anchor and connect it to a water intake.

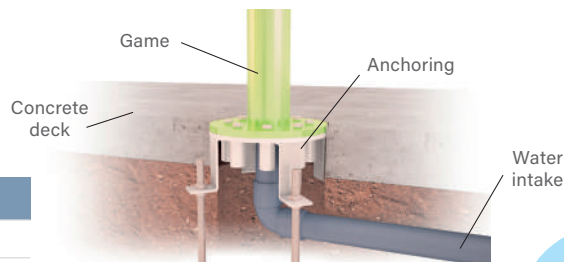
TECHNICAL FEATURES

Code	IS-30A47
Measurements	195 X 140 X 455 cm
Age range	4 - 15 years
Users	8 users
Water outlets	1 unit
Pool depth	From 0 to 35 cm
Pressure	105 Pa
Water flow	200 lpm



AstralPool Bike

AstralPool Bike



DESCRIPTION

Aquabike made of square and rectangular polished AISI-316L stainless steel pipe. Ideal for gyms, wellness centres, spas, medical facilities, hotels and private pools.

- Made of AISI-316L stainless steel.
- Adjustable height of saddle and handlebar.
- For use in public and residential pools from 1 to 1.5 metres in depth.
- Ergonomic.
- Pedals made of PUR.
- Easy to move about.

	Code	Standard Pack	Standard weight in kg	Standard volume in m ³
AstralPool Bike	67333	1	20	0.12

GENERAL NOTE FOR ALL MODELS

Made of PP stabilized against UV rays. The whole range comes in white. Ask your dealer about other colours.

Made up of tiles in modules for straight and curved sections (outer radius of 1 or 2 m), they click into place (male-female fitting), which gives certain leeway in assembling them, as well as absorbing their potential expansion due to the temperature changes to which they are exposed.

For all models of grating, a channel 5 mm wider than the grating must be built so that it easily fits into place and any potential expansion is prevented.

Channel width	Grating width
200.....	195
250.....	245
300.....	295
350.....	345

The height (h) of the grating varies depending on the model.

- Longitudinal model h = 24 mm
- Transversal model h = 22 mm and h = 35 mm

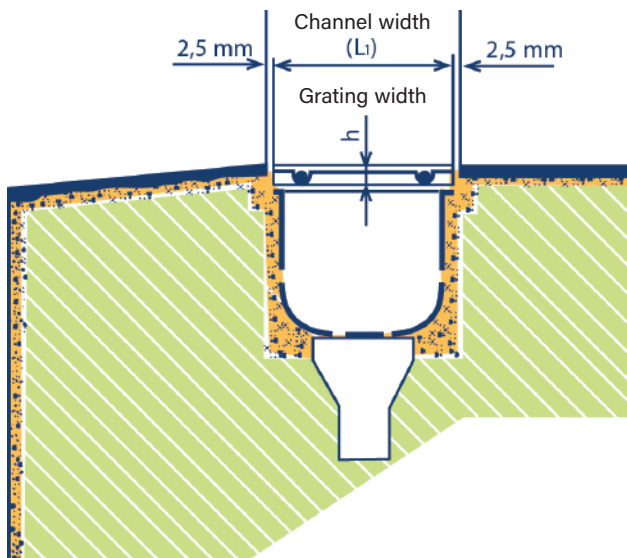

LONGITUDINAL MODEL

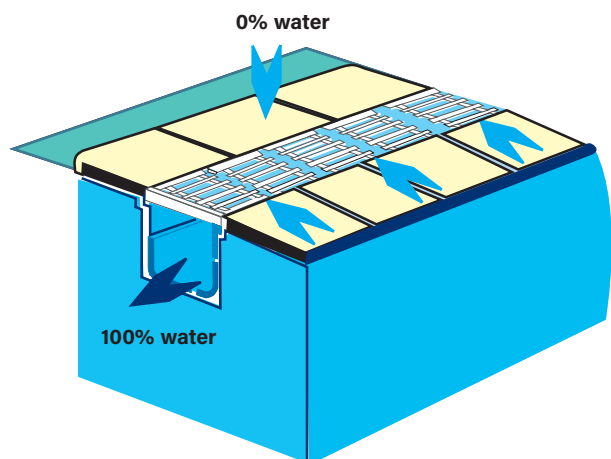

The longitudinal design of this model ensures that any excess water from the pool is not allowed to overflow onto the pool deck, thus maintaining it practically dry.

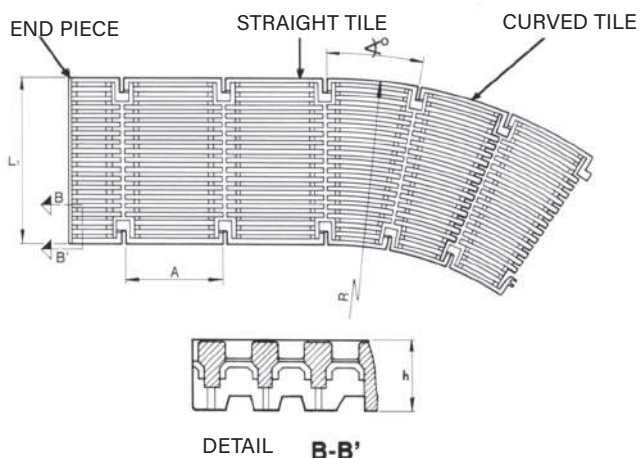

	Model	L	L1	h	A	⊘ r.1m.	⊘ r.2m.
STRAIGHT TILE	05581	200	195	24	206	-	-
	05582	250	245	24	206	-	-
	05583	300	295	24	206	-	-
	05584	350	345	24	206	-	-
END PIECE	06420	200	195	24	-	-	-
	06421	250	245	24	-	-	-
	06422	300	295	24	-	-	-
	06423	350	345	24	-	-	-
CURVED TILE	08001	200	195	24	-	x	
	08002	300	295	24	-	x	
	07565	250	245	24	-	x	
	07566	350	345	24	-	x	
	05585	200	195	24	-		x
	05586	250	245	24	-		x

Other grating colours can be made to order. For further information, ask your AstralPool dealer.



GRILLES FOR OVERFLOW

Longitudinal grating tile



DESCRIPTION

Made of PP stabilized against UV rays. Grating fastened together using male-female hooks (5 units = 1,024 meters). The flexible properties of the grating means a radius of up to 5 m can be covered.

	Code	Standard Pack	Standard weight in kg	Standard volume in m ³
Height 24 mm, width 195 mm	05581	45	16.2	0.080
Height 24 mm, width 245 mm	05582	29	13.4	0.080
Height 24 mm, width 291 mm	05583	28	15.6	0.080
Height 24 mm, width 345 mm	05584	19	13.2	0.080



Curved grating tile



DESCRIPTION

Made of PP stabilized against UV rays. Grating fastened together using male-female hooks.

Height	L	L1	Radius	Code	Standard Pack	Standard weight in kg	Standard volume in m ³
24 mm	200 mm	195 mm	1 m	08001	60	17.2	0.079
24 mm	300 mm	295 mm	1 m	08002	32	14.6	0.079
24 mm	250 mm	245 mm	1 m	07565	42	17.2	0.079
24 mm	350 mm	345 mm	1 m	07566	24	13.4	0.079
24 mm	200 mm	195 mm	2 m	05585	48	17.2	0.079
24 mm	250 mm	245 mm	2 m	05586	30	14.2	0.079



End piece kit for parallel grating



DESCRIPTION

Made of AISI-304L stainless steel plate, with end piece and longitudinal grating made of PP stabilized against UV rays. Made so that the grating in the end piece can be cut to fit in place.

	Code	Standard Pack	Standard weight in kg	Standard volume in m ³
Height 24 mm, width 195 mm	16064	15	5.11	0.002
Height 24 mm, width 245 mm	16065	12	5.17	0.002
Height 24 mm, width 291 mm	16066	8	4.21	0.002
Height 24 mm, width 345 mm	16067	8	5.00	0.002

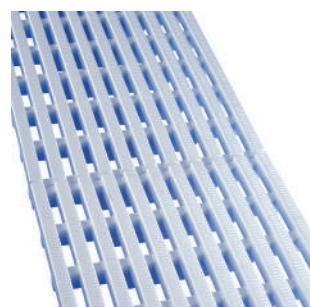

Perimeter grating



DESCRIPTION

Range of overflow grating for swimming pools. Made of homopolymer polypropylene, with additives for UV protection. Available in 500 mm long modules with male-female hooks for easy and fast assembly.

	Code	Standard Pack	Standard weight in kg	Standard volume in m ³
0.5 m longitudinal grating Height 22 mm Width 195 mm	28664	20	19.9	0.080

Modular transversal grating for curves

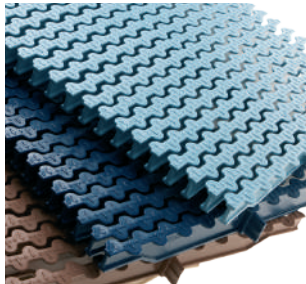
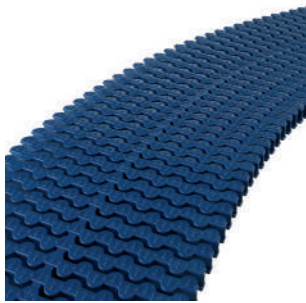

Other grating colours can be made to order. For further information, ask your AstralPool dealer.

DESCRIPTION

Made of PP stabilized against UV rays. Assembled by fitting the modules together. Available in 5 colours. Other grating colours can be made to order. For further information, please contact your AstralPool dealer.

	Code	Standard Pack	Standard weight in kg	Standard volume in m ³
Modular grating for curves				
Height 22 mm, width 195 mm	34190	470	14.1	0.08
Height 22 mm, width 245 mm	34191	320	12.4	0.08
Height 22 mm, width 295 mm	34192	300	15.0	0.08
Height 22 mm, width 335 mm	34193	250	15.0	0.08
Reversible modular grating for curves				
Height 35 mm, width 195 mm	34194	450	16.0	0.08
Height 35 mm, width 245 mm	34195	300	13.7	0.08
Height 35 mm, width 295 mm	34196	290	17.3	0.08
Height 35 mm, width 335 mm	34197	250	17.4	0.08

Note: Colours in the pictures are not exactly the same as in real product.

TECHNICAL FEATURES

Colour	Code
White	-
RAL 1015	CL90
RAL 8002	CL109
RAL 5003	CL60
RAL 5024	CL 108

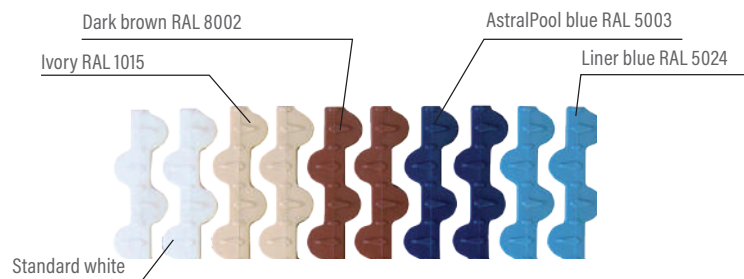

Other grating colours can be made to order. For further information, ask your AstralPool dealer.

Transversal grating for curves

DESCRIPTION

Modular transversal grating for curves. Made of PP stabilized against UV rays. Assembled by fitting the modules together. Class 3 slip resistance (Rd>45) pursuant to UNE-ENV 12633: 2003.

	Code	Standard Pack	Standard weight in kg	Standard volume in m ³
Modular grating for curves				
Height 22 mm, width 195 mm	52535	470	14.1	0.08
Height 22 mm, width 245 mm	52536	320	12.4	0.08
Height 22 mm, width 295 mm	52537	300	15.0	0.08
Height 22 mm, width 335 mm	52538	250	15.0	0.08
Reversible modular grating for curves				
Height 35 mm, width 195 mm	52539	450	16.0	0.08
Height 35 mm, width 245 mm	52540	300	13.7	0.08
Height 35 mm, width 295 mm	52541	290	17.3	0.08
Height 35 mm, width 335 mm	52542	250	17.4	0.08

Other grating colours can be made to order. For further information, ask your AstralPool dealer.

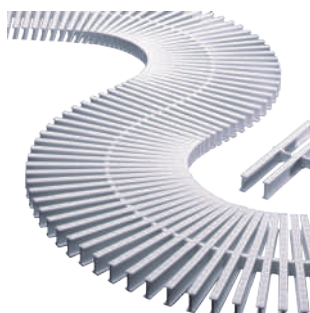

GRILLES FOR OVERFLOW

Modular transversal grating for curves

DESCRIPTION

Made of PP stabilized against UV rays. Assembled by fitting the modules together.

	Code	Standard Pack	Standard weight in kg	Standard volume in m ³
Modular grating for curves				
Height 22 mm, width 195 mm	11107	470	15.8	0.080
Height 22 mm, width 245 mm	11108	320	13.6	0.080
Height 22 mm, width 295 mm	19202	300	18.0	0.080
Height 22 mm, width 335 mm	19203	250	17.0	0.080
Reversible modular grating for curves				
Height 35 mm, width 195 mm	00220	450	16.5	0.080
Height 35 mm, width 245 mm	00221	300	14.3	0.080
Height 35 mm, width 295 mm	00222	290	19.3	0.080
Height 35 mm, width 335 mm	00223	250	18.1	0.080

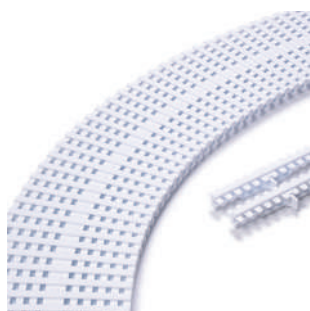

Modular grating for curves

DESCRIPTION

Made of PP stabilized against UV rays. Assembled by fitting the modules together. Non-slip surface. Other colours available on request. For further information, please contact your AstralPool dealer. Compliant with standard EN-13451-1 (8 mm). Class 3 slip resistance (Rd>45) pursuant to UNE-ENV 12633: 2003.

	Code	Standard Pack	Standard weight in kg	Standard volume in m ³
Modular grating for curves				
Height 22 mm, width 195 mm	28656	470	20.84	0.082
Height 22 mm, width 245 mm	28657	320	18.80	0.082
Height 22 mm, width 295 mm	28658*	300	18.80	0.082
Height 22 mm, width 335 mm	28659*	250	20.84	0.082
Reversible modular grating for curves				
Height 35 mm, width 195 mm	28660	450	26.90	0.082
Height 35 mm, width 245 mm	28661	300	24.70	0.082
Height 35 mm, width 295 mm	28662*	290	26.61	0.082
Height 35 mm, width 335 mm	28663*	250	22.25	0.082

* In testing process.

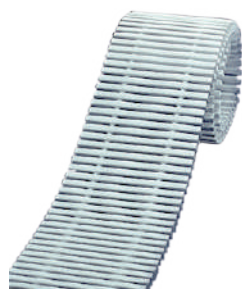

Transversal grating

DESCRIPTION

Made of PP stabilized against UV rays. Fastened together by a pass-through cable (49 units per metre).

	Code	Standard Pack	Standard weight in kg	Standard volume in m ³
Height 22 mm, width 195 mm	00212	340	11.9	0.039
Height 22 mm, width 245 mm	00213	305	13.2	0.039

GRILLES FOR OVERFLOW

Stainless steel plastic coated cable



DESCRIPTION

Ø 2.5 mm for fastening modules together.

	Code	Standard Pack	Standard weight in kg	Standard volume in m ³
Stainless steel plastic coated cable	00214	1000 m	21.0	0.036

AISI-316L stainless steel plastic coated cable



DESCRIPTION

Ø 2.5 mm for fastening modules together.

	Code	Standard Pack	Standard weight in kg	Standard volume in m ³
AISI-316L stainless steel plastic coated cable	00215	1000 m	21.0	0.036

Cable locking pins



DESCRIPTION

Made of brass.

	Code	Standard Pack	Standard weight in kg	Standard volume in m ³
Cable locking pins	00216	100	1.5	0.001

Transversal grating tile



DESCRIPTION

Made of PP stabilized against UV rays. Tiles fitted together using a snap fastening system (5 units = 0.975 m).

	Code	Standard Pack	Standard weight in kg	Standard volume in m ³
Height 22 mm, width 245 mm	00217	52	22.8	0.080
Height 22 mm, width 295 mm	00218	45	23.1	0.080
Height 22 mm, width 335 mm	00219	38	22.0	0.080

Other grating colours can be made to order. For further information, ask your AstralPool dealer.

Grating support profile



DESCRIPTION

Suitable for grating heights of 22, 24 and 35 mm. Made of weather resistant plastic. Supplied in 2 m strips.

Inside measurements: 24 mm x 37 mm.

Available in other colours. For further information, ask your dealer.

	Code	Standard Pack	Standard weight in kg	Standard volume in m ³
Grating support profile	00224	25	13.2	0.033

GRILLES FOR OVERFLOW

90° corner tiles for overflow channels



Other grating colours can be made to order. For further information, ask your AstralPool dealer.

DESCRIPTION

Made of white, injection moulded copolymer polypropylene.

	Code	Standard Pack	Standard weight in kg	Standard volume in m ³
Height 22 mm, channel width 195 mm	22379	4	2.8	0.006
Height 22 mm, channel width 245 mm	22380	4	3.6	0.009
Height 22 mm, channel width 295 mm	22381	4	4.8	0.012
Height 22 mm, channel width 335 mm	22382	4	5.7	0.016
Height 35 mm, channel width 195 mm	22383	4	3.2	0.009
Height 35 mm, channel width 245 mm	22384	4	4.1	0.014
Height 35 mm, channel width 295 mm	22385	4	5.3	0.012
Height 35 mm, channel width 335 mm	22386	4	6.2	0.023



Stainless steel longitudinal grating

DESCRIPTION

Longitudinal grating made of stainless steel. A channel 5 mm wider than the grating must be dug so that it is easy to fit.

It is made up of straight sections of AISI-316L stainless steel, 500 mm in length. Straight sections can be made to measure in order to fit the length of any pool.

There are 4 different models depending on the grating used. Height 35 mm.



Complies with Standard EN 13451-1:3



Complies with Standards EN 16582-1 EN 16713-2

	Code	Standard Pack	Standard weight in kg	Standard volume in m ³
In stainless steel				
195 mm longitudinal grating	32415	-	-	-
245 mm longitudinal grating	32416	-	-	-
295 mm longitudinal grating	32417	-	-	-
345 mm longitudinal grating	32418	-	-	-



Stainless steel reinforced grating

DESCRIPTION

AISI-316L stainless steel grating, compliant with standard EN: 1345-1:2000. Resistant to salt water. Intended for use in both residential and public pools.

	Code	Standard Pack	Standard weight in kg	Standard volume in m ³
Reinforced 252 x 252 mm grating	70956	1	-	-
Reinforced 410 x 410 mm grating	70957	1	-	-

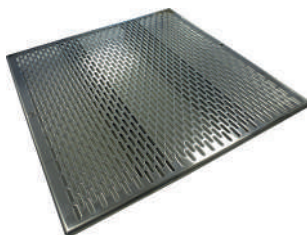

Complies with Standard EN 1345-1:2000





COMMERCIAL POOLS

POOL SHELL EQUIPMENT



618 CONCRETE POOL

- 618 Main Drains
- 621 Main Drains accessories
- 622 Main drain grilles
- 623 ABS Inlets
- 625 Stainless Steel Inlets

626 LINER AND PREFABRICATED POOL

- 626 Main drains
- 629 Main drains accessories
- 629 Main drain grilles
- 630 ABS Inlets
- 632 Stainless Steel Inlets

Concrete pool - Main drains

Pool main drains information

How affects UNE-EN 13451-3:2012+A3:2016 main drains in commercial pools

NEW POOL	POOL RENOVATION
----------	-----------------

Suction rate: insure a maximum of 0.5 m/s paragraph 4.6.1

	ANTI-VORTEX COVER	NON ANTI-VORTEX COVER	WITH MAIN DRAIN BODY CHANGE	UNCHANGED MAIN DRAIN BODY
RISK OF ENTRAPMENT How to prevent it?	Number of main drains per pool: 1 According to paragraph 4.6.1b (1,2 and 3)	Number of main drains per pool: 2 balanced main drains, distanced at minimum 2 meters. And if any of the 2 main drain is blocked the remaining one should be able to absorb 100% of the installation flow. According to paragraph 4.6.1a (1,2 and 3)	Applies new pool rules	Install an anti-vortex grille on pre-installed main drain According to paragraph 4.6.1b (1,2 and 3) or one or more additional main drain shall be installed as paragraph 4.6.1a (1,2 and 3)

Another possibility is to install a compensating tank.

CAVITY DIMENSION Main drain should respect a certain cavity dimensions according to a mathematical rule.

In addition to the main drain requirements a vacuum system may be provided.

OTHERS Other requisites are considered to define that a main drain in compliant with EN, like design. e.g. the design of the grill to avoid human body parts or hair entrapment.

Only with the fulfillment of all requisites of the standard, a Compliance Certification can be delivered!

*Anti-vortex plate is a special component installed in the suction line to control the turbulence in a flowing fluid. These plates allows to control the velocity of the fluid thus preventing cavitation in the fluid according to UNE-EN 13451-3.

Concrete pool - Main drains

- All main drains in the range are supplied with UV protection.
- To prevent the risk of suction, install the main drains according to local regulations.
- Recommended use: Maximum suction rate of 0.5 m/s.
- Install at least 2 main drains, each with a suction capacity able to handle the pool's full flow rate.

NORM main drain



Also available in other colours

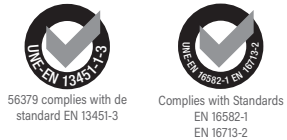

DESCRIPTION

Range of main drains suitable for public and private swimming pools. Supplied with flat or antivortex grilles. Manufactured in ABS with UV treatment, fitted with a 2" side outlet and a 1½" bottom outlet connection, bottom outlet covered by semi-die cut tab.

	Code	Standard Pack	Standard weight in kg	Standard volume in m³
Flat grating				
White	56378	4	10.60	0.069
Beige	56378CL090	4	10.60	0.069
Light Grey	56378CL129	4	10.60	0.069
Anthracite Grey	56378CL144	4	10.60	0.069
Antivortex grating				
White	56379	4	10.60	0.069
Beige	56379CL090	4	10.60	0.069
Light Grey	56379CL129	4	10.60	0.069
Anthracite Grey	56379CL144	4	10.60	0.069

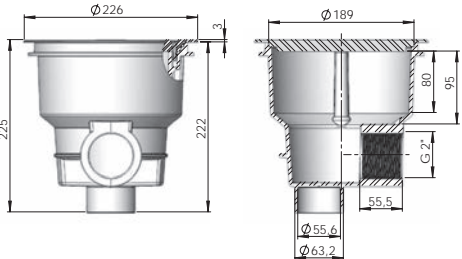

Main drain with square cover in stainless steel. 2" outlet



DESCRIPTION

2" side outlet. Manufactured in stainless steel. AISI-316. Antivortex lid. Can be used in concrete and prefabricated pools with a 00276 adapter (see page 133). Maximum flow rate: 6 m³/h.

	Code	Standard Pack	Standard weight in kg	Standard volume in m³
	00269	1	1.14	0.01

Concrete pool - Main drains

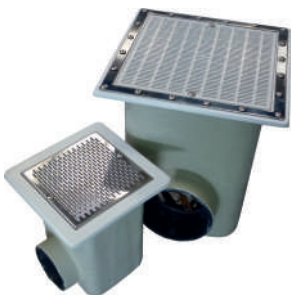

NORM main drain

in polyester and fibreglass - 330 mm x 330 mm



DESCRIPTION

Range of main drains manufactured in polyester resin and fibreglass. Grille in stainless steel AISI-316L. Optional hydrostatic valve. Minimum depth of installation: 1.5 m. Maximum recommended flow rate down drain: 103 m³/h (0.5 m/s).



Complies with Standard EN 13451-1/3 2012

	Code	Standard Pack	Standard weight in kg	Standard volume in m ³	
Outlet connection to be glued	Flow rate				
Ø 75 mm	15 m ³ /h	20282N	1	8	0.08
Ø 90 mm	23 m ³ /h	20283N	1	9	0.08
Ø 110 mm	27 m ³ /h	20284N	1	10	0.08

Main drain

in polyester and fibreglass - 330 mm x 330 mm



DESCRIPTION

With a gelcoat finish. With optional hydrostatic valve. Maximum recommended flow rate in accordance with standard EN 13451-1.



	Code	Standard Pack	Standard weight in kg	Standard volume in m ³	
Grille in stainless steel AISI-316L. Holes < 8 mm					
Outlet connection to be glued	Flow rate				
Ø 75 mm	16 m ³ /h	20282	1	5	0.047
Ø 90 mm	22 m ³ /h	20283	1	5	0.047
Ø 110 mm	33 m ³ /h	20284	1	5	0.047

Grille in ABS plastic with protection against UV rays.

	Code	Standard Pack	Standard weight in kg	Standard volume in m ³	
Outlet connection to be glued	Flow rate				
Ø 75 mm	16 m ³ /h	22359	1	4.5	0.034
Ø 90 mm	22 m ³ /h	22360	1	4.5	0.034
Ø 110 mm	33 m ³ /h	22361	1	4.5	0.034
Ø 125 mm	43 m ³ /h	22362	1	4.5	0.034

Optional standard American size and antivortex in standard American size

NORM main drain

in polyester and fibreglass - 507 mm x 507 mm

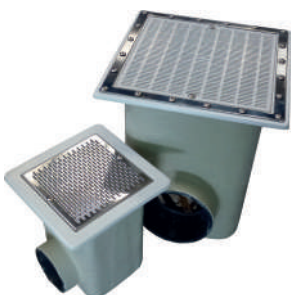

DESCRIPTION

Range of drains manufactured in polyester resin and fibreglass. Grille in AISI-316L stainless steel. Optional hydrostatic valve. Minimum depth of installation: 1.5 m. Maximum recommended flow rate down drain: 103 m³/h (0.5 m/s).



Complies with Standard EN 13451-1/3 2012

	Code	Standard Pack	Standard weight in kg	Standard volume in m ³	
Outlet connection to be glued	Flow rate				
Ø 110 mm	42 m ³ /h	20285N	1	16	0.23
Ø 125 mm	51 m ³ /h	20286N	1	17	0.23
Ø 140 mm	66 m ³ /h	20287N	1	18	0.23
Ø 160 mm	95 m ³ /h	20288N	1	19	0.23
Ø 200 mm	103 m ³ /h	20289N	1	20	0.23

Optional standard American size

Concrete pool - Main drains

Main drain

in polyester and fibreglass - 507 mm x 507 mm

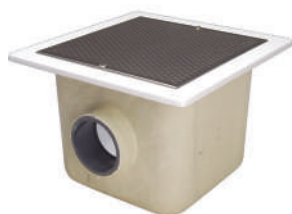

DESCRIPTION

With a gelcoat finish. With optional hydrostatic valve. Maximum recommended flow rate in accordance with standard EN 13451-1.

		Code	Standard Pack	Standard weight in kg	Standard volume in m ³
Grille in AISI-316L stainless steel. Holes < 8 mm					
Outlet connection to be glued	Flow rate				
Ø 110 mm	33 m ³ /h	20285	1	11.5	0.132
Ø 125 mm	43 m ³ /h	20286	1	11.5	0.132
Ø 140 mm	54 m ³ /h	20287	1	11.5	0.132
Ø 160 mm	70 m ³ /h	20288	1	11.5	0.132
Ø 200 mm	100 m ³ /h	20289	1	11.5	0.132
Grille in ABS plastic with protection against UV rays.					
Outlet connection to be glued	Flow rate				
Ø 110 mm	33 m ³ /h	28709	1	11.5	0.132
Ø 125 mm	43 m ³ /h	28710	1	11.5	0.132
Ø 140 mm	54 m ³ /h	28711	1	11.5	0.132
Ø 160 mm	70 m ³ /h	28712	1	11.5	0.132
Ø 200 mm	100 m ³ /h	28713	1	11.5	0.132

Concrete pool - Main drain accessories

Hydrostatic valve



DESCRIPTION

To alleviate the pressure that can build up under the pool shell due to groundwater, it is recommended that a hydrostatic valve and a drainage pipe be fitted to the main drain. Hydrostatic valve to be fitted to the 2" bottom outlet on main drains. Made of white ABS, with stainless steel screw and spring. 1½" male thread..

	Code	Standard Pack	Standard weight in kg	Standard volume in m ³
	00277	50	2.63	0.01

Drainage pipe



DESCRIPTION

Drainage pipe with 1½" BSP thread connection for main drains with code numbers 01466, 27837 and 27839. Made of ABS.

	Code	Standard Pack	Standard weight in kg	Standard volume in m ³
	21581	24	3.54	0.021

POOL SHELL EQUIPMENT

Concrete pool - Main drain grilles

Flush-fit antivortex cover



Complies with Standard
EN 13451-1-3

DESCRIPTION

Special flush-fit design that enables pool cleaners to go over it without blocking it up. Smooth slopes.

The 415 mm x 415 mm cover (25344) can be fitted to the following main drains:

With stainless steel grille: With plastic grille:

- | | |
|--------|--------|
| -20282 | -22359 |
| -20283 | -22360 |
| -20284 | -22361 |
| | -22362 |

The 570 mm x 570 mm cover (28556) can be fitted to the following main drains:

With stainless steel grille: With plastic grille:

- | | |
|--------|--------|
| -20285 | -28709 |
| -20286 | -28710 |
| -20287 | -28711 |
| -20288 | -28712 |

	Code	Standard Pack	Standard weight in kg	Standard volume in m ³
415 mm x 415 mm, Height: 70 mm	25344	1	2.25	0.012
570 mm x 570 mm, Height: 60 mm	28556	1	4.00	0.032



Drain grille in stainless steel



DESCRIPTION

Designed for concrete pools. Support frame and grille in polished stainless steel. Supplied with fixing screws. Other sizes can be made to order.

	Code	Standard Pack	Standard weight in kg	Standard volume in m ³
AISI-304				
Size (mm)	Max. recommended flow rate			
200 x 200	00284	1	1.2	0.01
300 x 300	00285	1	2.2	0.01
400 x 400	00286	1	4.0	0.03
500 x 500	00287	1	4.5	0.04
AISI-316				
Size (mm)	Max. recommended flow rate			
200 x 200	30764	1	1.2	0.01
300 x 300	30765	1	2.2	0.01
400 x 400	30766	1	4.0	0.03
500 x 500	30767	1	4.5	0.04



Complies with Standard
EN 13451-1-3



Complies with Standards
EN 16582-1
EN 16713-2

Concrete pool - ABS Inlets

Return inlet/suction nozzle

for high flow rates



Complies with Standards
EN 16582-1
EN 16713-2

DESCRIPTION

Return inlet for large flow rates that can also be used as a suction nozzle. Maximum suction flow rate of 30m³/h for a maximum flow rate speed of 4 m/s. Maximum suction flow rate of 5 m³/h for a maximum flow rate speed of 0.5 m/s. PVC body. Connection for Ø 75 or Ø 90mm pipe. Inlets can be installed into bushing 43590 (see page 141). Grille can be adjusted in any direction

	Code	Standard Pack	Standard weight in kg	Standard volume in m ³
Return inlet/suction nozzle for large flows and concrete pools	41520	16	4.20	0.021

NORM return inlets



Complies with Standards
EN 16582-1
EN 16713-2

DESCRIPTION

Range of inlets suitable for installation in public and private pools. Manufactured in white ABS with UV treatment.

	Code	Standard Pack	Standard weight in kg	Standard volume in m ³
NORM return inlet for concrete pools	56498	24	4.5	0.020

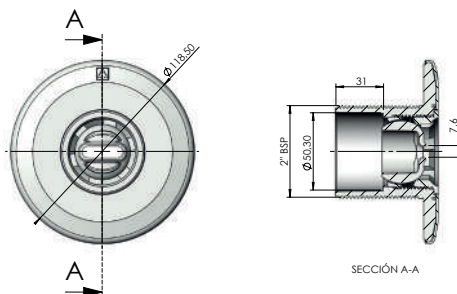

Pool floor return inlet



00303



00303CL090



00303CL129



00303CL144



Complies with Standards
EN 16582-1
EN 16713-2

DESCRIPTION

All-in-one return inlet and suction nozzle. Adjustable flow rate. Made of ABS plastic and screws in stainless steel. Maximum recommended flow rate compliant with standard EN 13451-1: 12 m³/h.

	Code	Standard Pack	Standard weight in kg	Standard volume in m ³
Outer 2" thread, int. Ø 50 mm				
White	00303	24	5.0	0.020
Beige	00303CL090	24	5.0	0.020
Light Grey	00303CL129	24	5.0	0.020
Anthracite Grey	00303CL144	24	5.0	0.020
To glue onto Ø 63 mm PN 6, inner Ø 50 mm	20140	20	4.4	0.021

Concrete pool - ABS Inlets

3" adjustable pool floor

return inlet



DESCRIPTION

Made of white ABS plastic. Suction. Flow rate adjusted by turning the grille. Suction surface area: 0.015 m². Outer Ø 295 mm wall. Flow rate (0.4 m/s) 20 m³/h. Max. recommended flow rate compliant with standard EN 13451-1: 26 m³/h (0.5 m/s).

	Code	Standard Pack	Standard weight in kg	Standard volume in m ³
Grille in AISI-304 stainless steel	08317	2	2.65	0.047
Grille in white ABS	11796	2	2.65	0.047

Pool floor return inlet

with swivel joint



DESCRIPTION

Swivel body in PVC. Cover in ABS. Adjuster screw in POM. Maximum flow rate of 10 m³/h. Fits to Ø 75 mm piping and wall conduit with code number 21248.

	Code	Standard Pack	Standard weight in kg	Standard volume in m ³
White	22353	24	4.1	0.022
Beige	22353CL090	24	4.1	0.022
Light Grey	22353CL129	24	4.1	0.022
Anthracite Grey	22353CL144	24	4.1	0.022



Complies with Standards
EN 16582-1
EN 16713-2

Suction inlet



DESCRIPTION

To be glued to a Ø 63 mm pipe. Body and grille in ABS plastic, screws in stainless steel. Application on wall. Its characteristics make this nozzle particularly suitable for overflow channels. Maximum flow rate: 4.5 m³/h.

	Code	Standard Pack	Standard weight in kg	Standard volume in m ³
	00302	12	3.1	0.016

Concrete pool - Stainless Steel Inlets



Adjustable pool floor return inlet



DESCRIPTION

2" external thread. Made of AISI-316L stainless steel. Can be fitted in concrete and prefabricated pools. The water flow can be adjusted by loosening or tightening the central screw. Max. recommended flow rate compliant with standard EN 13451-3: 14 m³/h.



Complies with Standard
EN 13451-3



Complies with Standards
EN 16582-1
EN 16713-2

Code	Standard Pack	Standard weight in kg	Standard volume in m ³
15839	1	0.9	0.002



Adjustable return inlet



DESCRIPTION

Manufactured in chrome-plated brass. Grille in AISI-316L stainless steel.



Complies with Standard
EN 13451-3



Complies with Standards
EN 16582-1
EN 16713-2

Code	Standard Pack	Standard weight in kg	Standard volume in m ³
00312	12	7.0	0.013
00313	6	10.0	0.014

Max. flow rate: 21 m³/h 2" inner thread
Max. flow rate: 40 m³/h 3" inner thread

Liner and prefab. pool - Main drains

- + All main drains in the range are supplied with UV protection.
- + To prevent the risk of suction, install the main drains according to local regulations.
- + Recommended use: Maximum suction rate of 0.5 m/s.
- + Install at least 2 main drains, each with a suction capacity able to handle the pool's full flow rate.

NORM main drain



DESCRIPTION

Range of main drains suitable for installation in public and private pools. Supplied with flat or antivortex grilles. Manufactured in ABS with UV treatment, fitted with a 2" side outlet and a 1½" bottom outlet connection, bottom outlet covered by semi-die cut tab.



56382 and 56383
complies with Standard
EN 13451-1-3



Complies with Standards
EN 16582-1
EN 16713-2

	Code	Standard Pack	Standard weight in kg	Standard volume in m ³
Flat grating with inserts				
White	56380	4	10.60	0.069
Beige	56380CL090	4	10.60	0.069
Light Grey	56380CL129	4	10.60	0.069
Anthracite Grey	56380CL144	4	10.60	0.069
Flat grating without inserts				
White	56381	4	10.60	0.069
Beige	56381CL090	4	10.60	0.069
Light Grey	56381CL129	4	10.60	0.069
Anthracite Grey	56381CL144	4	10.60	0.069
Antivortex grating with inserts				
White	56382	4	10.60	0.069
Beige	56382CL090	4	10.60	0.069
Light Grey	56382CL129	4	10.60	0.069
Anthracite Grey	56382CL144	4	10.60	0.069
Antivortex grating without inserts				
White	56383	4	10.60	0.069
Beige	56383CL090	4	10.60	0.069
Light Grey	56383CL129	4	10.60	0.069
Anthracite Grey	56383CL144	4	10.60	0.069

Liner and prefab. pool - Main drains

NORM main drain in polyester and fibreglass - 350 mm x 350 mm



DESCRIPTION

Range of main drains manufactured in polyester resin and fibreglass. Grille in stainless steel. Optional hydrostatic valve. Minimum depth of installation: 1.5 m. Maximum recommended flow rate down drain: 103 m³/h (0.5 m/s).



Complies with Standard EN 13451-1-3



Complies with Standards EN 16582-1

Optional standard American size and antivortex in standard American size

Code	Standard Pack	Standard weight in kg	Standard volume in m ³
------	---------------	-----------------------	-----------------------------------

Grille in stainless steel

Outlet connection to be glued

Outlet connection	Flow rate	Code	Standard Pack	Standard weight in kg	Standard volume in m ³
Ø 75 mm	15 m ³ /h	20074N	1	8	0.08
Ø 90 mm	23 m ³ /h	20075N	1	9	0.08
Ø 110 mm	27 m ³ /h	20290N	1	10	0.08

NORM main drain in polyester and fibreglass - 507 mm x 507 mm

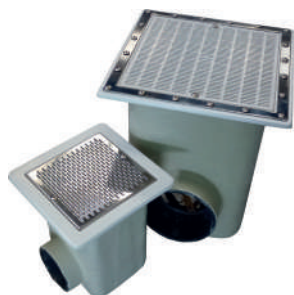

DESCRIPTION

Range of main drains manufactured in polyester resin and fibreglass. Grille in stainless steel or plastic. Optional hydrostatic valve. Minimum depth of installation: 1.5 m. Maximum recommended flow rate down drain: 103 m³/h (0.5 m/s).



Complies with Standard EN 13451-1-3

Optional standard American size and antivortex in standard American size

Code	Standard Pack	Standard weight in kg	Standard volume in m ³
------	---------------	-----------------------	-----------------------------------

Grille in stainless steel

Outlet connection to be glued

Outlet connection	Flow rate	Code	Standard Pack	Standard weight in kg	Standard volume in m ³
Ø 110 mm	42 m ³ /h	20076N	1	16	0.23
Ø 125 mm	51 m ³ /h	20077N	1	17	0.23
Ø 140 mm	66 m ³ /h	20078N	1	18	0.23
Ø 160 mm	95 m ³ /h	20079N	1	19	0.23
Ø 200 mm	103 m ³ /h	20291N	1	20	0.23

Liner and prefab. pool - Main drains

Main drain in polyester and fibreglass - 350 mm x 350 mm



Complies with Standards
EN 16582-1

Optional:
Standard American sizes

DESCRIPTION

Made of fibreglass-reinforced polyester. With a gelcoat finish. Comes with gaskets, flange and screws. Holes < 8 mm. Outlet connection to be glued. With optional hydrostatic valve.

	Code	Standard Pack	Standard weight in kg	Standard volume in m ³
Grille in stainless steel				
Outlet connection to be glued	Flow rate			
Ø 75 mm	16 m ³ /h	20074	1	6.5
Ø 90 mm	22 m ³ /h	20075	1	6.5
Ø 110 mm	33 m ³ /h	20290	1	6.5

Max. recommended flow rate: 33.5 m³/h (0.5 m/s). Recommended flow rate: 20 m³/h (0.3 m/s).

Grille in ABS plastic with protection against UV rays

	Code	Standard Pack	Standard weight in kg	Standard volume in m ³
Outlet connection to be glued	Flow rate			
Ø 75 mm	18 m ³ /h	22416	1	6.5
Ø 90 mm	27 m ³ /h	22417	1	6.5
Ø 110 mm	42 m ³ /h	22418	1	6.5
Ø 125 mm	45 m ³ /h	22419	1	6.5

Max. recommended flow rate: 45 m³/h (0.5 m/s). Recommended flow rate: 27 m³/h (0.3 m/s)



Main drain in polyester and fibreglass - 507 mm x 507 mm



DESCRIPTION

With a gelcoat finish. Grille in AISI-316L stainless steel. Comes with gaskets, flanges and screws. Holes < 8 mm. Outlet connection to be glued. Recommended flow rate: 62 m³/h (0.3 m/s). Max. recommended flow rate: 103 m³/h (0.5 m/s). With optional hydrostatic valve.

	Code	Standard Pack	Standard weight in kg	Standard volume in m ³
Grille in stainless steel				
Outlet connection to be glued	Flow rate			
Ø 110 mm	42 m ³ /h	20076	1	1.4
Ø 125 mm	51 m ³ /h	20077	1	1.4
Ø 140 mm	66 m ³ /h	20078	1	1.4
Ø 160 mm	95 m ³ /h	20079	1	1.4
Ø 200 mm	103 m ³ /h	20291	1	1.4
Grille in ABS plastic with protection against UV rays				
Outlet connection to be glued	Flow rate			
Ø 110 mm	42 m ³ /h	28722	1	1.4
Ø 125 mm	51 m ³ /h	28723	1	1.4
Ø 140 mm	66 m ³ /h	28724	1	1.4
Ø 160 mm	95 m ³ /h	28725	1	1.4
Ø 200 mm	103 m ³ /h	28726	1	1.4

Liner and pref. pool - Main drain accessories



Hydrostatic valve



DESCRIPTION

To alleviate the pressure that can build up under the pool shell due to groundwater, it is recommended that a hydrostatic valve and a drainage pipe be fitted to the main drain. Hydrostatic valve to be fitted to the 2" bottom outlet on main drains. Made of white ABS, with stainless steel screw and spring. 1½" male thread.

	Code	Standard Pack	Standard weight in kg	Standard volume in m³
	00277	50	2.63	0.01



Drainage pipe



DESCRIPTION

Drainage pipe with 1½" BSP thread connection for main drains with code numbers 00270, 07880, 27838, 26197 and 27125. Made of ABS.

	Code	Standard Pack	Standard weight in kg	Standard volume in m³
	21581	24	3.54	0.021



Complies with Standards EN 16582-1

Liner and prefab. pool - Main drain grilles

Flush-fit antivortex cover



DESCRIPTION

Special flush-fit design that enables pool cleaners to go over it without blocking it up.

The 415 mm x 415 mm cover (25344) can be fitted to the following main drains:

With stainless steel grille: **With plastic grille:**

- | | |
|--------|--------|
| -20074 | -22416 |
| -20075 | -22417 |
| -20290 | -22418 |
| | -22419 |

The 570 mm x 570 mm cover (28556) can be fitted to the following main drains:

With stainless steel grille: **With plastic grille:**

- | | |
|--------|--------|
| -20076 | -28722 |
| -20077 | -28723 |
| -20078 | -28724 |
| -20079 | -28725 |



	Code	Standard Pack	Standard weight in kg	Standard volume in m³
415 mm x 415 mm, Height: 70 mm	25344	1	2.25	0.012
570 mm x 570 mm, Height: 60 mm	28556	1	3.90	0.015



Complies with Standard EN 13451-1:2000

Liner and prefab. pool - ABS Inlets

NORM return inlets



DESCRIPTION

Range of inlets suitable for installation in public and private pools. Manufactured in ABS with UV treatment.

	Code	Standard Pack	Standard weight in kg	Standard volume in m ³
For prefabricated/liner pools				
White	56499	12	4.5	0.020
Beige	56499CL090	12	4.5	0.020
Light Grey	56499CL129	12	4.5	0.020
Anthracite Grey	56499CL144	12	4.5	0.020
For prefabricated pools				
White	56500	24	4.5	0.020
Beige	56500CL090	24	4.5	0.020
Light Grey	56500CL129	24	4.5	0.020
Anthracite Grey	56500CL144	24	4.5	0.020

Pool floor return inlet

for prefabricated pools



DESCRIPTION

Return nozzle. Comes with gaskets, flanges and screws. Adjustable flow rate. Max. flow rate: 12 m³/h.

	Code	Standard Pack	Standard weight in kg	Standard volume in m ³
2" outer thread and internal Ø 50 mm				
White	00340	12	5.4	0.020
Beige	00340CL090	12	5.4	0.020
Light Grey	00340CL129	12	5.4	0.020
Anthracite Grey	00340CL144	12	5.4	0.020
To be glued Ø 63 mm PN 6 outer wall, Ø 50 mm inner				
White	20139	12	5.4	0.021

BCN03 pool floor return inlet



DESCRIPTION

Adjustable pool floor return inlet for liner pools. Designed to be glued to the inside of PN6 and PN10 piping. Made of white ABS, with self-tapping screws or with metal inserts. Plastic or stainless steel flange, depending on the model. Maximum flow rate: 9.5 m³/h.

	Code	Standard Pack	Standard weight in kg	Standard volume in m ³
PN6 self-tapping plastic flange	28230	12	3.25	0.031
With PN6 plastic flange inserts	28231	12	3.55	0.031
PN10 self-tapping stainless steel flange	28501	12	4.24	0.031
With PN10 stainless steel inserts	28502	12	4.54	0.031



Complies with Standards
EN 16582-1
EN 16713-2

Liner and prefab. pool - ABS Inlets

BCN03 adjustable pool floor return inlet



DESCRIPTION

Pool floor return inlet for liner pools. Thanks to the adjustable feature, its installation in the pool floor is made extremely easy as it can be fitted after the concrete has been laid with wall conduit 43590.

	Code	Standard Pack	Standard weight in kg	Standard volume in m ³
With plastic flange inserts	43586	12	2.04	0.033
Plastic self-tapping flange	43587	12	2.04	0.033
With stainless steel flange inserts	43588	12	2.04	0.033
Self-tapping stainless steel flange	43589	12	2.04	0.033

3" adjustable pool floor return inlet



DESCRIPTION

Made of white ABS. Suction. Comes with gaskets, flanges and screws. Flow rate adjusted by turning the grille. Suction surface area: 0.015 m². Flow rate at 0.4 m/s: 20 m³/h. Max. recommended flow rate: 26 m³/h. (0.5 m/s.).

	Code	Standard Pack	Standard weight in kg	Standard volume in m ³
Grille in AISI-304 stainless steel	08316	2	2.65	0.047
Grille in white ABS	11795	2	2.65	0.047

Double gasket kit



DESCRIPTION

Kit made up of a double gasket and the screws necessary for the installation of nozzles in panel pools. Made of TPE, the kit enables the installation of various accessories in pool shells and protects the panelling from coming into contact with water. Easy to install. Prevents corrosion of the panelling in the area that has been die cut.

	Code	Standard Pack	Standard weight in kg	Standard volume in m ³
Inserts for nozzles	43455-0500	80	-	0.035

Return inlet/suction nozzle for high flow rates



DESCRIPTION

Return inlet for large flow rates that can also be used as a suction nozzle. Maximum suction flow rate of 30m³/h for a maximum flow rate speed of 4 m/s. Maximum suction flow rate of 5 m³/h for a maximum flow rate speed of 0.5 m/s. PVC body. Connection for Ø 75 or Ø 90 mm pipe. Inlets can be installed into bushing 43590. Grille can be adjusted in any direction.

	Code	Standard Pack	Standard weight in kg	Standard volume in m ³
Panel pools	41518	10	5.50	0.021
Prefabricated pools	41521	12	4.20	0.021

Liner and prefab. pool - ABS Inlets



Suction nozzle for overflow

poools with liner



DESCRIPTION

PVC body. Maximum flow rate of 7 m³/h for a maximum flow rate velocity of 0.5 m/s. Connection for Ø 75 or Ø 90 piping. Nozzle with double gasket. Thanks to the design of the flange, the nozzle is able to take in all of the water in the overflow channel.

	Code	Standard Pack	Standard weight in kg	Standard volume in m ³
	41519	12	4.83	0.021

Liner and pref. pool - Stainless Steel Inlets



Adjustable pool floor

return inlet



DESCRIPTION

2" external thread. Made of AISI-316L stainless steel. Can be fitted in concrete and prefabricated pools. The water flow can be adjusted by loosening or tightening the central screw. Max. recommended flow rate complaint with standard EN 13451-3: 14 m³/h.



Complies with Standard
EN 13451-1-3



Complies with Standards
EN 16582-1
EN 16713-2

	Code	Standard Pack	Standard weight in kg	Standard volume in m ³
	15839	1	0.9	0.002





COMMERCIAL POOLS

BUILDING SOLUTIONS



636 LINER AND PREFABRICATED POOLS

- 636 Modular prefabricated pools
- 639 Inxpool

642 SKYPOOL COMMERCIAL PROJECTS

- 642 SkyPool



645 BLUESPRING

- 645 Bluespring

647 CLASSIC CUSTOM AND PROFESSIONAL

- 647 Classic custom and Professional

Modular prefabricated pools



Freestanding modules for pools and spas, with a reinforced, waterproof composite, ready for the final coating.

Prefabricated modules with all accessories and wall conduits to ensure watertightness in the event of vibrations and water hammer.

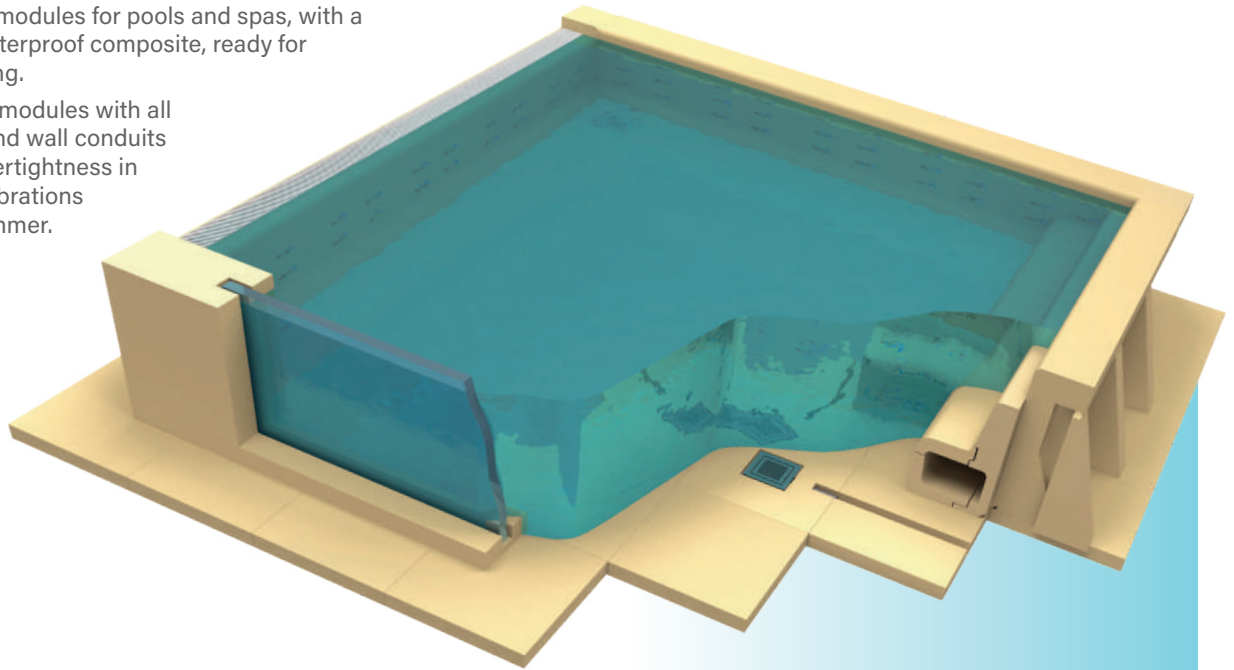

The thermal expansion coefficient of our prefabricated modules is far superior to that of concrete, as a result of which they do not crack over time because structural movement due to expansion and contraction are absorbed.

Ideal for refurbishments, roof tops, basements, etc. Their modular design makes them extremely easy to transport and work freely on the building site.

Exclusive designs without any restrictions, thanks to our computer-controlled systems that enable our clients to come up with their own designs without the need for casts, thus avoiding manual errors.

The prefabricated component parts make it possible to build and refurbish pools to the designers exact specifications, as well as enabling a pool to have exactly the same finish as a traditional one.

-  Installation on complex sites
-  Modular and freestanding
-  Energy savings
-  Resistant to water load
Lightweight framework
-  Prefabricated system

Modular prefabricated pools



The top finish can be directly applied to the insulation material, which protects it from potential condensation between gaps that give rise to the proliferation of micro-organisms that are a health hazard for humans. Hardly any power loss ($\lambda = 0,033 \text{ W/mK}$) in comparison with concrete ($\lambda = 2,30 \text{ W/mK}$), which means it pays for itself in a very short space of time.



To ask for a quote, contact your area sales rep.

COMPARATIVE POWER CONSUMPTION TABLE

86% savings

CONCRETE	2.3 W/mK
Pool Material	0.033 W/mK

Energy conductivity figures as shown in the Spanish Technical Building Code (CTE).

LIGHTWEIGHT FRAMEWORK

2320 kg lighter per m³

CONCRETE	2,400 kg/m ³
Pool Material	80 kg/m ³

COMPARATIVE WATER VOLUME TABLE

920 kg lighter per m³

WATER	1,000 kg/m ³
Pool Material	80 kg/m ³

Volume of compact bench 0.27 m³

Modular prefabricated pools - One-off projects



IBEROSTAR BAHIA PALMA POOL

74,520 kg concrete | **31.05 m³**
 2,484 kg prefabricated modules

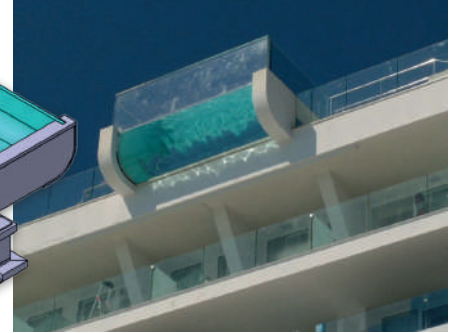
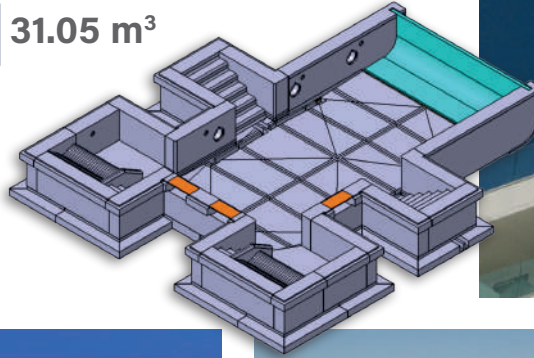

CALDEA KIDS POOL

85,104 kg concrete | **35.46 m³**
 2,837 kg prefabricated modules

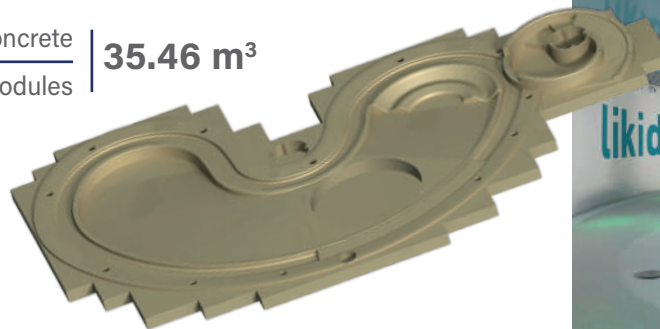

Inoxpool



- + Constructed in one piece of AISI-316L satin stainless steel. Thickness of 2 mm. With overflow channel. Non-slip floor. Hydraulic pre-installation included. Ready to connect. Easy installation, without building work.
- + Total security and quality. In order to satisfy all your needs we have designed these models of stainless steel pools for those looking for an elegant and sober lifestyle. The quality of their materials and finishes set them apart. They are a gift for the senses!
- + 2 Different models:

COMFORT

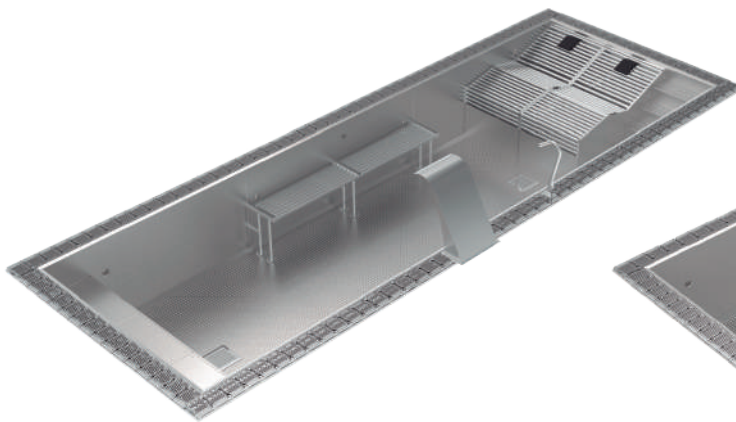

SPORT



MODEL COMPARISON

	5 x 3 x 1.2 m	7 x 3 x 1.2 m		9 x 3 x 1.2 m		12 x 3 x 1.2 m	
MODELS	Sport	Comfort	Sport	Comfort	Sport	Comfort	Sport
Code	71503	71509	71510	71516	71517	71523	71524

General specifications

Internal dimensions (m)	5 x 2.85 x 1.2	7 x 2.85 x 1.2		8.84 x 2.85 x 1.2		11.84 x 2.85 x 1.2	
External dimensions (m)	5.7 x 3.6 x 1.3	7.7 x 3.6 x 1.3		9.6 x 3.6 x 1.3		12.6 x 3.6 x 1.3	
Water capacity (m ³)	18	24		31		41	
Empty weight / Full weight (kg)	2300 / 20300	3300 / 27300	2550 / 26550	3700 / 34700	3050 / 34050	4500 / 45500	3850 / 44850

Characteristics

Skimmers	-	-	-	-	-	-	-
Overflow suction	2	2	2	3	3	4	4
Return inlet	3	4	3	5	4	6	5
Bottom cleaner nozzle	1	1	1	1	1	2	2
Main drains	2	2	2	2	2	2	2
Projectors	2	2	2	2	2	3	3

Accessories

Ladder (3 steps)	•	-	•	-	•	-	•
Steps	-	•	-	•	-	•	-
Hydromassage bench	-	•	-	•	-	•	-
Hydromassage cascade	-	•	-	•	-	•	-
Hydromassage water jet	-	•	-	•	-	•	-
Hydromassage beds	-	•	-	•	-	•	-
Countercurrent	•	-	•	-	•	-	•
Cover	-	•	-	•	-	•	-

Recommended equipment

Hydraulic button and timer	-	45218 + 35761	-	45218 + 35761	-	45218 + 35761	-
Blower pump for hydro beds	-	31091	-	31091	-	31091	-
Blower pump for hydro bank	-	35388	-	35388	-	35388	-

Inoxpool - Installation



PREPARATION OF THE GROUND



The base the spa or pool must be prepared.

TRANSFER TO LOCATION



Manufactured in one piece, your transfer must be made by an authorized mode of transport.



The transfer must be made in a reinforced trailer or truck so that it arrives at its destination in perfect condition.

TRANSFER BY CRANE



Facilities must have easy access (outside) to be able to install the crane that will help to unload the Spa or Pool and put it in place.

UNLOADING THE POOL



The installation must be checked and secured so that everything is in perfect order.

LEVELING AND ADJUSTMENTS



Assembling the connections and putting it into operation is the last step before you can enjoy a relaxing and dreamed of space of well-being.

Ask for your new **Spa & Pool INOX SOLUTION** catalogue by AstralPool

SPA & POOL INOX SOLUTION





PANEL POOLS, THE VERY LATEST TECHNOLOGY THAT ENSURES PRECISION AND ACCURACY

The easiest, quickest and surest way of building any required residential and commercial pool. SkyPool is AstralPool’s range of prefabricated panel pools that can be adapted to fit existing infrastructures or new ones.



The use of these totally prefabricated panels that are easy to fasten and assemble together means that an in-ground or above-ground pool can be built in record time.

The steel panels undergo hot-dip galvanisation in a bath of zinc, which gives them excellent protection against rusting so that they last longer and their safety is guaranteed throughout their service life.

SkyPool - Experts in end-to-end solutions

Thanks to SkyPool, AstralPool is the undisputed world leader in prefabricated pools made of galvanized steel panels. Our flexibility and drive, in addition to the way we adapt to the needs and regulations of each market have led us to build pools in more than 60 countries, which has made us one of the companies with the greatest international outreach in the sector.

Award-winning competition pools.

As leaders in this sector, we have longstanding experience in the development of solutions for the world of competition. We make pools of any size including the required by FINA standards and regulations.

End-to-end solutions.

AstralPool has a multidisciplinary team able to give you support in the development of your project from beginning to end, as well as the degree of experience and know-how expected of a world leader:

- Project analysis.
- Preliminary design study and quote.
- Advice and water treatment.
- Manufacture.
- Worksite management.
- Installation of complete solutions.



SkyPool - The best choice for many reasons



Quick

The use of completed prefabricated components together with the easy assembly system considerably reduces the time required to build a pool.



Versatile

This system can be used for any design, whatever a pool's shape.



Long-lasting

New design and manufacturing systems are used to obtain maximum quality, functionality and durability of all pool components. The metal structure has a 20-year warranty.



Lightweight

Choose a place and we'll build a pool there! The advantage of the lightweight structure that is easily adaptable is that pools can be built even in awkward conditions. Small spaces, rooftops, stadiums, etc.



Inexpensive

As no complex infrastructure has to be built, a high performance pool can be obtained at a lower cost.



Reliable

The use of the very best components, together with a totally safe construction system, delivers the reliability required in this type of facility.



Sustainable

All components can be recycled, are non-contaminating and are manufactured using processes with a low environmental impact.

SkyPool - Advantages

1. Technology.

Thanks to the technology used in the construction of SkyPool panels, they are fully compliant with FINA regulations. There is an extremely easy and efficient system for adjusting the level and angles of a pool. The access through the system's manholes enables all adjustment to be made.

2. Watertight. No leaks.

There are no cracks. The perfect fit of the assembled SkyPool panels covered by the liner ensure the pool shell is completely watertight. Furthermore, the system has been designed to withstand land movements and subsidence, in addition to the pressure exerted when a pool is emptied or filled.

3. High resistance finishes.

The PVC-P reinforced liner used by SkyPool is watertight, which gives these pools a high level of safety, protection, robustness and durability. Furthermore, it is resistant to chlorinated water and aging caused by external agents. The liner ensures elasticity and is available with a wide range of optional features (colours, etc.).

4. Quicker installation time.

It can take as much as two months off the time to manufacture and install an Olympic SkyPool (50 x 25 x 2 m) in comparison with a concrete pool. This considerably reduces indirect and opportunity costs.

5. Low maintenance.

As there is access to the pool perimeter, any problems are more quickly located, so repair and maintenance work is easier and costs less.

6. Earthquakes resistant.

Build earthquake-resistant pools. The team of Skypool engineers calculates and adapts the system according to the seismic regulations of each country. Under request.

SkyPool - Panel models

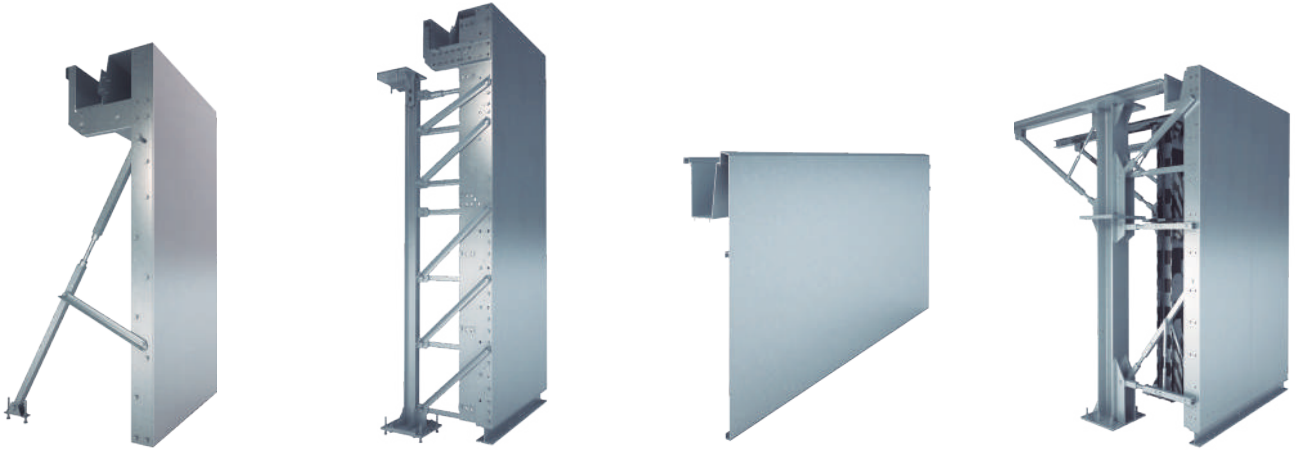

BARCELONA PANEL

Freestanding galvanized steel panel suitable for pools of up to 2.5 m. Fastenings are only required at the bottom.

CAR PANEL

Freestanding galvanized steel panel suitable for pools of up to 3 m. Fastenings are required at the top and on the bottom.

RENOVATION PANEL

Freestanding galvanized steel panel suitable for pools of up to 2.5 m. Fastenings are only required at the bottom.

MELBOURNE PANEL

Freestanding galvanized steel panel suitable for pools of up to 3 m with structure to install the surround of the pool.



BLUESPRING

Bluespring



When the sides of the overflow blend with the sky and with the surrounding atmosphere, the fulfillment of the perfect pool is realized, the time when the pool disappears and binds to the infinite lines.

Bluespring is designed to give space to the architectural interventions to harness the magic of the different types of overflow available. The structure has been designed to maintain the integrity of the performances over the years, getting its point of excellence in the reliability using. The best technology at the service of demanding customers who believe in the beauty of their own water space.

- A Reinforced concrete slab
- B Steel structure
- C Compensation channel
- D Perimetric flooring
- E Reinforced membrane
- F Concrete reinforcement
- G Terrapieno
- H Fasteners



POOL WARRANTY: 5 YEARS
ACCESSORIES WARRANTY: 2 YEARS

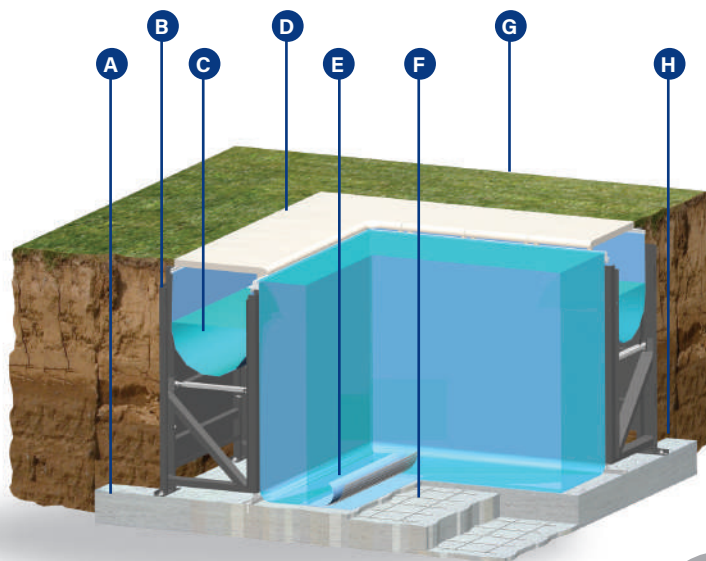
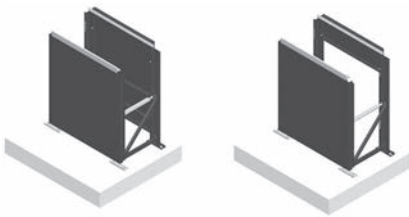

The Bluespring structure technology is made of galvanized and passivated steel with low-carbon Z275 coverage, treated with the exclusive protective Laghetto ZMSV-TEC coating.

All the ground supports, the threaded rods anchors, the moving parts and the nuts and bolts are made of stainless steel.

The Bluespring ZMSV-TEC structure provides a full height ground retaining panel if used as a classical inground pool, or is equipped with a shortened panel in case it is mounted in above ground situations.

Bluespring offers two standard heights for the pool panel: **130 and 152 centimeters.**

Higher or variable water depth can be obtained directly by varying the design of the bottom slab.

Bluespring - Compensation system



With Bluespring balance tank is not necessary, thanks to the use of big and capacious overflow duct, which allows to avoid the construction of the external compensation tank, with consequent and evident of space and cost savings.

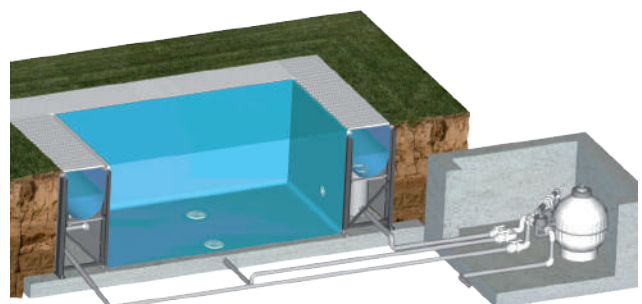



High-tech, endless beauty

When the sides of the overflow blend with the sky and with the surrounding atmosphere, the fulfillment of the perfect pool is realized, the time when the pool disappears and binds to the infinite lines.

Elegant and exclusive, Bluespring is the infinity pool suitable for every need: do sport comfortably at home, relax after work or enjoy time with the family, in the privacy of your own home.

The perimeter overflow is the best filtration system for floating impurities: the water overflows from the edge into the channel under the perimeter paving and enters the filtration system.

With the overflow channel, therefore, you will no longer need the external, underground, bulky and expensive compensation tank. Reduced construction times and low impact building works guarantee an immediately usable space; the self-supporting structure remains intact over the years and allows easy and quick maintenance and control.

The best technology at the service of demanding customers who believe in the beauty of their own water space.



CLASSIC CUSTOM AND PROFESSIONAL

Classic custom and Professional

- **MODEL:** Custom Professional
- **FAMILY:** Pool Design
- **INSTALLATION:** Above-ground for events
- **PRODUCT TYPE:** Pool with with hydrostatic structure
- **STRUCTURE:** Hot dip galvanized steel wilt powder coated parts.
- **POOL LINER:** Made of polyester with highly waterproof PVC coating
- **LINER COLOR:** Laghetto Blue
- **INSTALLATION:** UNI standards, for temporary use also
- **EQUIPMENT:** Tank (structure and liner), foot blocks. Filtration, skimmers and piping depending on customer project
- **OPTIONS:** Wintercovering, summercovering
- **SIZES:** Available heights: 60/100/120 cm (water heights)
- **WARRANTY:** 5 Years (structure and liner) - 2 Years (other parts and accessories)

<https://www.piscinelaghetto.com/en/product/home-design-en/custom-professional>

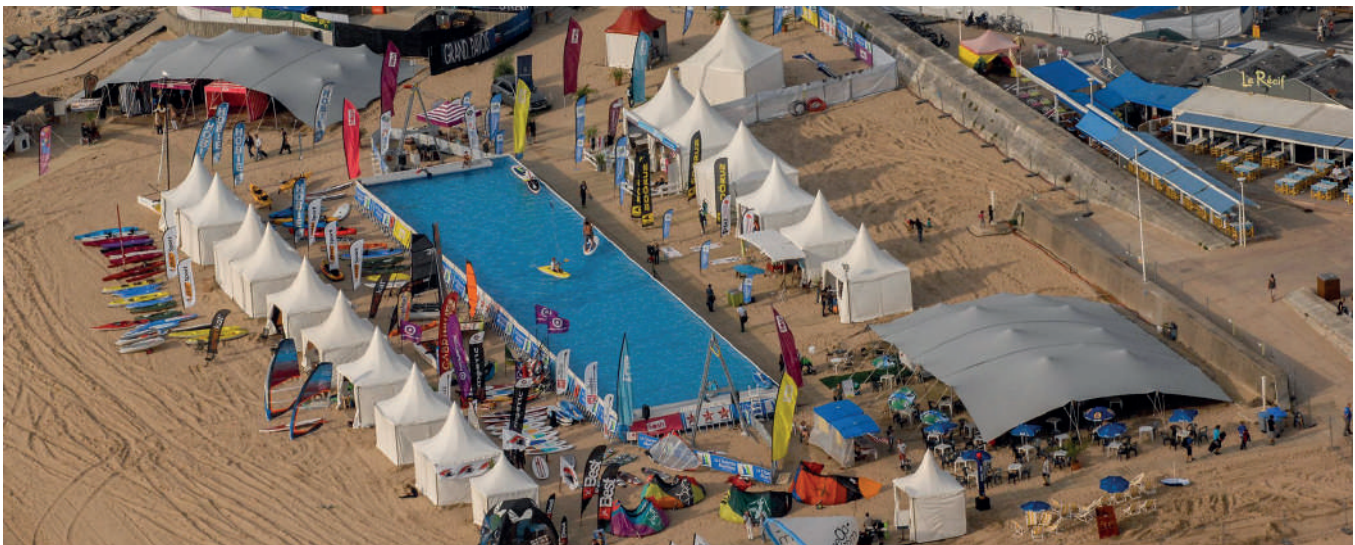

Classic custom and Professional



Custom



SPA & POOL INOX SOLUTION

E X C L U S I V I T Y



STAINLESS STEEL CRAFTSMEN

Our flexibility and dynamism, as well as our adaptation to the needs and regulations of each market, have led us to build steel solutions in more than 60 countries, making us one of the companies with the greatest international outreach in the sector.

INTEGRAL SOLUTIONS, UNIQUE DESIGNS
AND CUSTOM SOLUTIONS DEVELOPED
CREATE EXCLUSIVE SPACES IN A
WELLNESS ENVIRONMENT.

We put at your disposal all the tools and our broad experience to turn your project into reality, adapting our designs to the client's needs



www.astralpool.com
www.fluidra.com

FLUIDRA

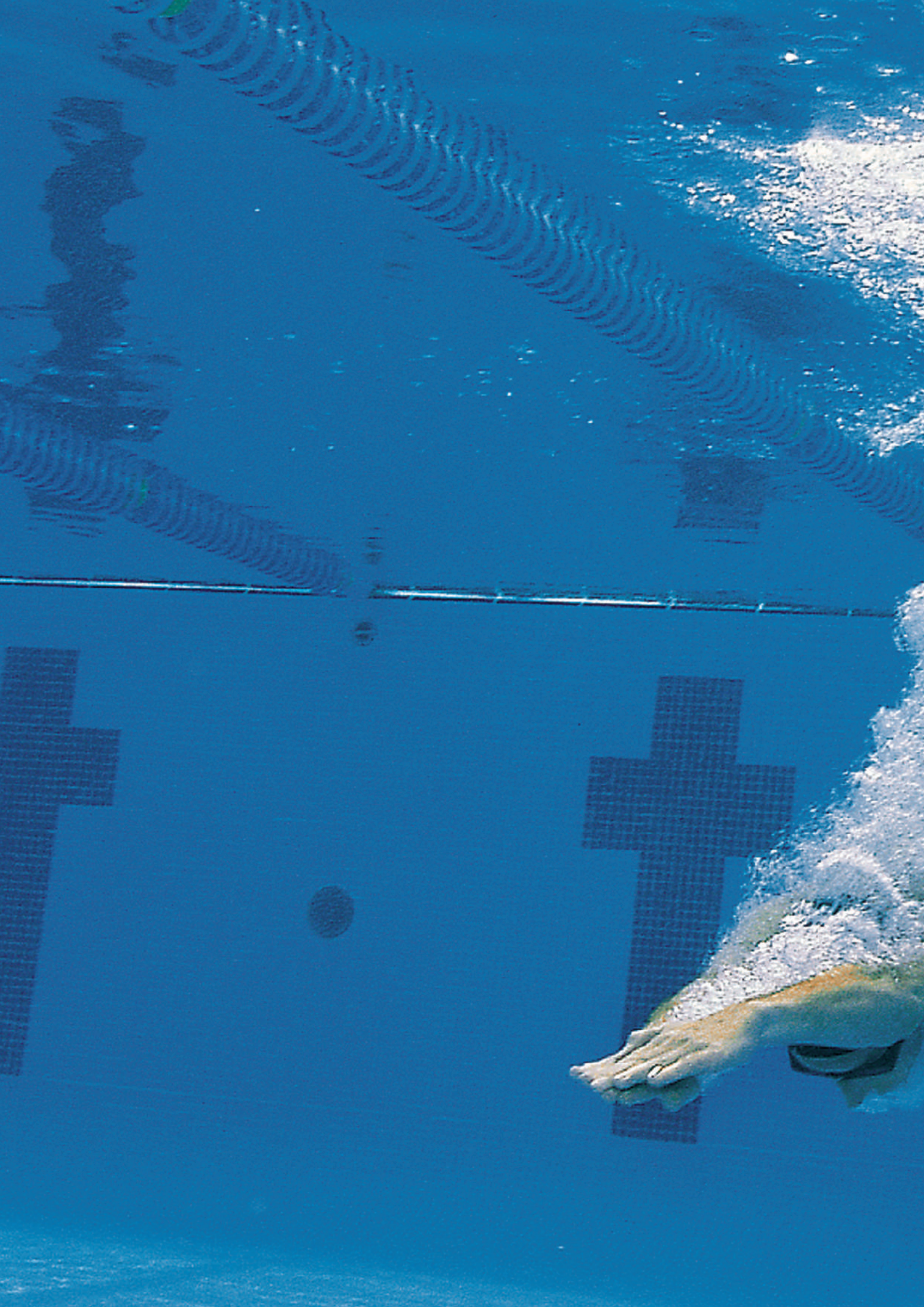

COMMERCIAL POOLS

FILTRATION



652 COMMERCIAL POOL FILTRATION CODING

653 LAMINATED FILTERS

- 653 Vesubio filters - Commercial pool series
- 654 Europe filters
- 656 DIN filters

658 BOBBIN WOUND FILTERS

- 658 Vic filters
- 660 Praga filters
- 662 2.5 bar OC-1 Praga filters
- 663 Vertical high performance bobbin wound filters
- 664 Oslo filters
- 667 Olot filters
- 669 Construction features of the filter according to DIN 18820
- 669 Rodas filters Ø 1050 mm and Ø 1200 mm
- 673 Rodas filters Ø 1400 mm and Ø 1600 mm
- 677 Rodas filters Ø 2000 mm and Ø 2350 mm
- 681 Rodas filters Ø 2500 mm

683 VALVE MANIFOLDS

- 683 Valve manifold coding
- 684 Valve manifold for one filter
- 685 Valve manifold Control Panel

686 VALVE MANIFOLD ACCESSORIES

- 686 Valve manifold brackets
- 686 Wall brackets for valve manifold
- 687 Air vents

687 FILTRATION MEDIA & ACCESSORIES

- 687 OC-1 filtration media
- 688 Active Clear Glass
- 688 Silex
- 688 Gravel
- 689 Anthracite
- 689 Zeolite
- 689 Gauge panel unit

Coding

The filter code is composed of eight digits. The first five digits correspond to the filter code and the last three digits correspond to the model – this information is given in the tables below.

This codification system is used for the Praga, Oslo, Olot, Ampuria, Rodas, Vic, Europe, Vesubio and Delta filters.

Position	1	2	3	4	5	-	6	7	8
----------	---	---	---	---	---	---	---	---	---

Position 1 to 5: Five digit code of the standard product.

Position 6 Specifies the nozzle plate and vinylester options	
0	Filter without nozzle plate
1	Filter with nozzle plate
2	Vinylester finish
3	With plate and vinylester
4	1" double effect priming valve kit
5	1" double effect priming valve kit + plate
6	1" double effect priming valve kit + plate and vinylester
7	2" double effect priming valve kit
8	2" double effect priming valve kit + plate
9	2" double effect priming valve kit + plate and vinylester

Position 7 Specifies side opening options	
0	Without nozzle plates
1	1 Ø 225 mm manhole
2	1 Ø 400 mm manhole
3	2 Ø 225 mm manholes
4	2 Ø 400 mm manholes
5	1 Ø 500 mm manhole
6	1 Ø 600 mm manhole

Position 8 Specifies sightglass options	
0	Without sightglasses
1	1 sightglass for laminated filter
2	1 Ø 135 mm sightglass
3	2 Ø 135 mm sightglasses
4	2 Ø 225 mm manholes

Notes: Rodas filters with nozzle plates are not available.

Ø 500 mm side opening for filters as of Ø 1050 mm.

Ø 600 mm side opening for filters as of Ø 1800 mm.

Maximum vinylester option of 0.5 ppm.

Please enquire pricing for various options:

- Vinylester finish
- Ø 225 mm and Ø 400 mm manhole
- Sightglass
- Plate

Head loss curve

Filters from Ø 1050 mm to Ø 3000 mm

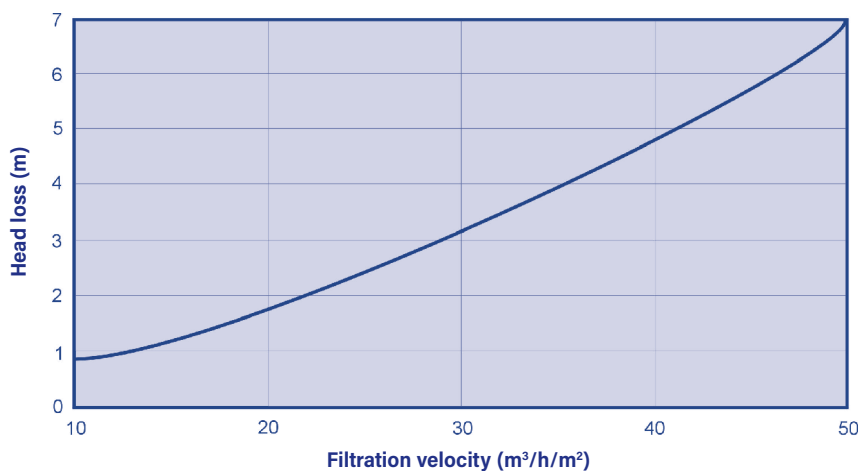

Vesubio filters - Commercial pool series



**Filtration bed
1 m**

**Maximum pressure:
2.5 kg/cm².**

**Optional:
Standard American sizes**

**NB: Coding options
according to table on
page 652**

DESCRIPTION

- Made of polyester resin and fibreglass.
- Equipped with pressure gauge, and manual air and water purge valves.
- Ø 400 mm cover
- Suitable for filtration speeds of 20, 30, 40 and 50 m³/h/m².
- Please ask your dealer for other speeds.
- All filters can be assembled with valve manifolds. 2½" sand discharge outlet.

Diameter Ø mm	Filtration velocity m ³ /h/m ²	Outlet Ø mm	Flow rate m ³ /h	Code	Standard Pack	Standard weight in kg	Standard volume in m ³
1050	20	63	17	41304	1	110	2.25
1050	30/40	75	25/34	41305	1	110	2.25
1050	50	90	43	41306	1	110	2.25
1200	20/30	75	22/33	41307	1	125	3.37
1200	40/50	90	45/56	41308	1	125	3.37
1400	20	75	30	41309	1	152	4.41
1400	30	90	46	41310	1	152	4.41
1400	40/50	110	61/77	41311	1	152	4.41
1600	20	90	40	41312	1	185	5.66
1600	30/40	110	60/80	41313	1	185	5.66
1600	50	125	100	41314	1	185	5.66
1800	20	90	50	41315	1	257	7.40
1800	30	110	76	41316	1	257	7.40
1800	40	125	101	41317	1	257	7.40
1800	50	140	125	41318	1	257	7.40
2000	20	110	62	41319	1	360	9.48
2000	30	125	94	41320	1	360	9.48
2000	40	140	125	41321	1	360	9.48
2000	50	160	157	41322	1	360	9.48

TECHNICAL FEATURES

Ø D (mm)	Filtration velocity (m ³ /h/m ²)	Code	Connections		Flow rate (m ³ /h)	Pool volume (8h) (m ³)	Filtration surface (m ²)	C (mm)	A (mm)	B (mm)	Ø D (mm)	Sand load (kg)	Gravel load (kg)	Grade 1 glass load (57011) (kg)	Grade 2 glass load (57012) (kg)	Grade 3 glass load (57013) (kg)
			mm	inches												
1050	20	41304	63	2"	17	136	0,86	1545	465	500	760	1125	175	678	221	244
	30/40	41305	75	2½"	25/34	200/272										
	50	41306	90	3"	43	344										
1200	20/30	41307	75	2½"	22/33	176/264	1,13	1730	675	500	850	1350	275	846	276	304
	40/50	41308	90	3"	45/56	360/448										
1400	20	41309	75	2½"	30	240	1,54	1845	725	500	1085	1850	350	1146	374	412
	30	41310	90	3"	46	368										
	40/50	41311	110	4"	61/77	488/616										
1600	20	41312	90	3"	40	320	2,01	1850	710	500	1230	2723	450	1654	540	595
	30/40	41313	110	4"	60/80	480/640										
	50	41314	125	4½"	100	800										
1800	20	41315	90	3"	50	400	2,54	1915	755	570	1370	3175	550	1941	634	698
	30	41316	110	4"	76	608										
	40	41317	125	4½"	101	808										
	50	41318	140	5"	125	1000										
2000	20	41319	110	4"	62	496	3,14	2030	775	570	1560	3650	675	2253	736	810
	30	41320	125	4½"	94	752										
	40	41321	140	5"	125	1000										
	50	41322	160	6"	157	1256										

Europe filters



Filtration bed
1 m

Maximum pressure:
2.5 kg/cm².

Does not include valve
manifold

* May be coupled with 2" multiport valve.
** May be coupled with 2½" multiport valve.

Optional:
Standard American sizes

NB: Coding options
according to table on
page 652

DESCRIPTION

- Made of polyester resin and fibreglass.
- Equipped with pressure gauge, and manual air and water purge valves.
- Ø 400 mm cover Suitable for filtration speeds of 20, 30, 40 and 50 m³/h/m².
- Please ask your dealer for other speeds.
- All filters can be assembled with valve manifolds. 2½" sand discharge outlet.

Diameter Ø mm	Filtration velocity m ³ /h/m ²	Outlet Ø mm	Flow rate m ³ /h	Code	Standard Pack	Standard weight in kg	Standard volume in m ³
1050	20*	63	17	20070	1	125	2.823
1050	30/40**	75	25/34	20071	1	125	2.823
1050	50	90	43	20072	1	125	2.823
1200	20/30	75	22/33	20068	1	150	3.597
1200	40/50	90	45/56	20069	1	150	3.597
1400	20	75	30	21497	1	214	4.90
1400	30	90	46	21498	1	214	4.90
1400	40/50	110	61/77	21499	1	214	4.90
1600	20	90	40	21500	1	230	6.50
1600	30/40	110	60/80	21501	1	230	6.50
1600	50	125	100	21502	1	230	6.50
1800	20	90	50	21503	1	344	8.80
1800	30	110	76	21504	1	344	8.80
1800	40	125	101	21505	1	344	8.80
1800	50	140	125	21506	1	344	8.80
2000	20	110	62	21507	1	435	10.58
2000	30	125	94	21508	1	435	10.58
2000	40	140	125	21509	1	435	10.58
2000	50	160	157	21510	1	435	10.58
2350	20	125	87	33820	1	600	15.70
2350	30	140	130	33822	1	600	15.70
2350	40	160	174	33824	1	600	15.70
2350	50	200	217	33826	1	600	15.70
2500	20	140	100	34302	1	630	-
2500	30	160	150	34303	1	630	-
2500	40	200	200	34304	1	630	-
2500	50	225	225	34305	1	630	-

TECHNICAL FEATURES

Ø (mm)	1050	1200	1400	1600	1800	2000	2350	2500
Depth of sand medium (m)	1	1	1	1	1	1	1	1
H (mm)	1860	1860	2000	2100	2200	2200	2430	2525
B (mm)	270*	350	400	400	400	400	400	500
A (mm)	540	570	615	710	725	805	950	1015
Ø P (mm)	760	850	1083	1230	1370	1558	1830	1830
E (mm)	170	180	240	250	270	300	355	-
Filtration surface areas (m ²)	0,86	1,13	1,54	2,01	2,54	3,14	4,34	4,9
Volume (l)	1250	1575	2185	2965	3850	4850	7230	9385
Sand load (kg)	1050	1360	1820	2375	3010	3750	5000	5600
Gravel load (kg)	265	325	410	515	760	1060	2000	2920
Grade 1 glass load (57011) (kg)	683	876	1160	1504	1959	2497	3622	4395
Grade 2 glass load (57012) (kg)	223	286	379	491	640	816	1183	1436
Grade 3 glass load (57013) (kg)	246	315	417	541	705	898	1302	1580
Total operating weight (kg)	2060	2600	3500	4700	6150	7800	10786	13800

* For 2" multiport valve the height will be 230 mm.

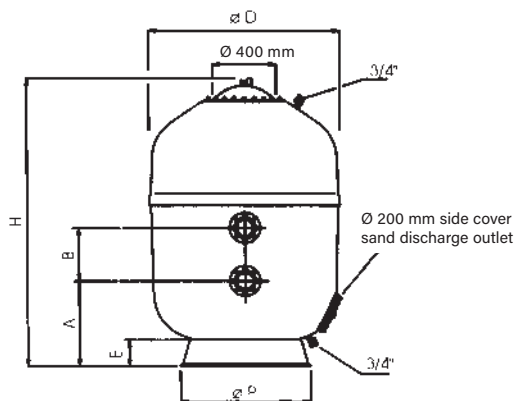

Europe filters



Filtration bed
1.2 m

Maximum pressure:
2.5 kg/cm².

Does not include valve
manifold

Optional:
Standard American sizes

DESCRIPTION

- Made of polyester resin and fibreglass.
- Equipped with pressure gauge, and manual air and water purge valves.
- Ø 400 mm cover Suitable for filtration speeds of 20, 30, 40 and 50 m³/h/m².
- Please ask your dealer for other speeds.
- All filters can be assembled with valve manifolds. 2½" sand discharge outlet.

Diameter Ø mm	Filtration velocity m ³ /h/m ²	Outlet Ø mm	Flow rate m ³ /h	Code	Standard Pack	Standard weight in kg	Standard volume in m ³
1050	20*	63	17	31857	1	140	3.04
1050	30/40**	75	25/34	31858	1	140	3.04
1050	50	90	43	31859	1	140	3.04
1200	20/30	75	22/33	31860	1	155	3.89
1200	40/50	90	45/56	31861	1	155	3.89
1400	20	75	30	21511	1	215	6.27
1400	30	90	46	21512	1	215	6.27
1400	40/50	110	61/77	21513	1	215	6.27
1600	20	90	40	21514	1	255	8.31
1600	30/40	110	60/80	21515	1	255	8.31
1600	50	125	100	21516	1	255	8.31
1800	20	90	50	21517	1	385	10.65
1800	30	110	76	21518	1	385	10.65
1800	40	125	101	21519	1	385	10.65
1800	50	140	125	21520	1	385	10.65
2000	20	110	62	21521	1	425	12.90
2000	30	125	94	21522	1	425	12.90
2000	40	140	125	21523	1	425	12.90
2000	50	160	157	21524	Optional	425	12.90
2350	20	125	87	33821	1	630	16.80
2350	30	140	130	33823	1	630	16.80
2350	40	160	174	33825	1	630	16.80
2350	50	200	217	33827	1	630	16.80
2500	20	140	100	34306	1	860	-
2500	30	160	150	34307	1	860	-
2500	40	200	200	34308	1	860	-
2500	50	225	225	34309	1	860	-

TECHNICAL FEATURES

Ø (mm)	1050	1200	1400	1600	1800	2000	2350	2500
Depth of sand medium (m)	1,2	1,2	1,2	1,2	1,2	1,2	1,2	1,2
H (mm)	2060	2060	2200	2300	2400	2400	2630	2675
B (mm)	270	350	400	400	400	400	400	500
A (mm)	540	570	615	710	725	805	950	1015
Ø P (mm)	760	850	1085	1230	1370	1560	1830	1830
E (mm)	170	180	240	250	270	300	355	-
Filtration surface areas (m ²)	0,86	1,13	1,54	2,01	2,54	3,14	4,34	4,90
Volume (l)	1500	1900	2650	3560	4620	5820	8060	-
Sand load (kg)	1300	1660	2220	2950	3680	4600	6130	6680
Gravel load (kg)	265	325	410	515	760	1060	2000	2920
Grade 1 glass load (57011) (kg)	815	1034	1370	1806	2311	2944	4215	4962
Grade 2 glass load (57012) (kg)	266	338	448	590	755	962	1377	1621
Grade 2 glass load (57012) (kg)	293	372	493	649	831	1059	1516	1784
Total operating weight (kg)	2375	2950	4000	5475	6950	8800	12180	14460

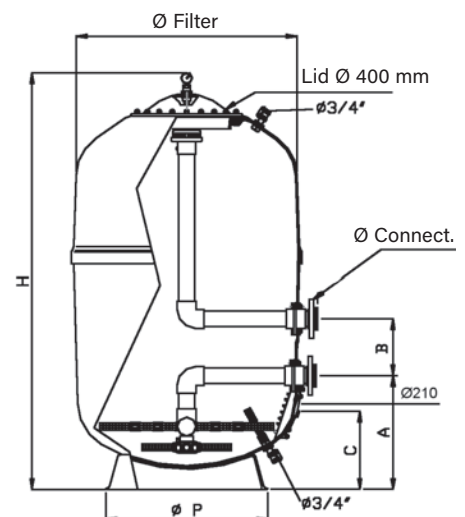

DIN filters



SINGLE LAYER



MULTILAYER



Filtration bed
1.2 m

DESCRIPTION

Laminated filter made of polyester resin and fibreglass. According to standard DIN 19643/19605. Ral 5015 colour code.

It is characterised by:

- Bolts in 316 AISI.
- Outlet clear water above nozzle plate in Europe.
- Nozzle plate system 65 units / m².
- 5 years warranty in tank.
- Maximum pressure: 2.5 bar.
- Maximum temperature 50° C.
- Sight glass 50 x 300 mm (one or two sight glasses, depending on model).
- Filter bed height 1,2 m.
- Freeboard 0,5 m.
- Connections in polyester.
- Lateral manhole d.400 in all models except Norma DIN 650 with d.200 mm.
- Top manhole d.400 mm in all models except Norma DIN 650 and 800 with d.200 mm.

OPTIONAL FEATURES

- Maximum pressure 4 bar.
- Ozone resistance 10mg/l (DIN 18820).

	Code	Standard Pack	Standard weight in kg	Standard volume in m ³
Monolayer - 1 sight glass				
DIN Standard				
Ø 650 mm	66033 126 000	1	-	1.88
Ø 800 mm	66034 126 000	1	-	2.70
Ø 1000 mm	66035 126 000	1	-	4.30
Ø 1200 mm	66036 126 000	1	-	4.98
Europe DIN				
Outlet water above nozzle plate				
Ø 1400 mm	66037 126 000	1	-	7.85
Ø 1600 mm	66038 126 000	1	-	9.40
Ø 1800 mm	66039 126 000	1	-	12.40
Ø 2000 mm	66040 126 000	1	-	15.49
Outlet water under nozzle plate				
Ø 1400 mm	66685 126 000	1	-	7.85
Ø 1600 mm	66686 126 000	1	-	9.40
Ø 1800 mm	66687 126 000	1	-	12.40
Ø 2000 mm	66688 126 000	1	-	15.49
Multilayer - 2 sight glasses				
DIN Standard				
Ø 650 mm	66033 127 000	1	-	1.88
Ø 800 mm	66034 127 000	1	-	2.70
Ø 1000 mm	66035 127 000	1	-	4.30
Ø 1200 mm	66036 127 000	1	-	4.98
Europe DIN				
Outlet water above nozzle plate				
Ø 1400 mm	66037 127 000	1	-	7.85
Ø 1600 mm	66038 127 000	1	-	9.40
Ø 1800 mm	66039 127 000	1	-	12.40
Ø 2000 mm	66040 127 000	1	-	15.49
Outlet water under nozzle plate				
Ø 1400 mm	66685 127 000	1	-	7.85
Ø 1600 mm	66686 127 000	1	-	9.40
Ø 1800 mm	66687 127 000	1	-	12.40
Ø 2000 mm	66688 127 000	1	-	15.49

DIN filters

TECHNICAL FEATURES

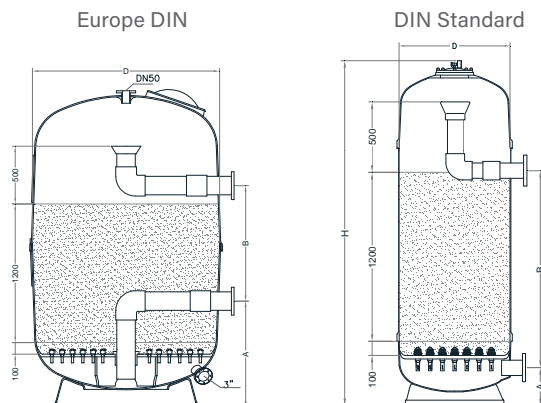

Monolayer - Outlet water above nozzle plate for European DIN.

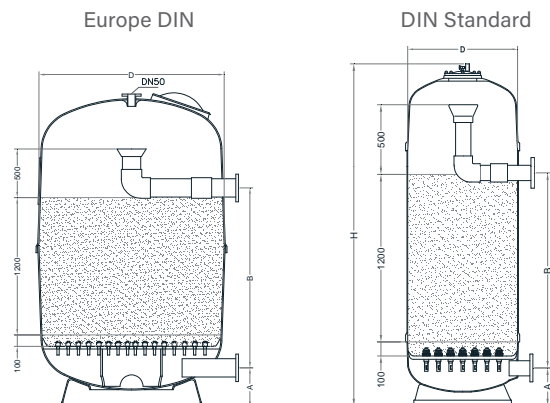

Monolayer - Outlet water under nozzle plate.

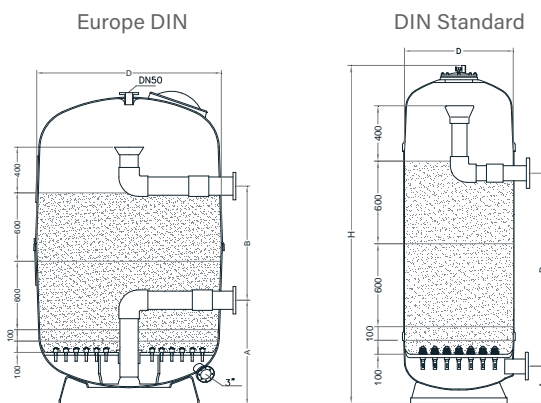

Multilayer - Outlet water above nozzle plate for European DIN.

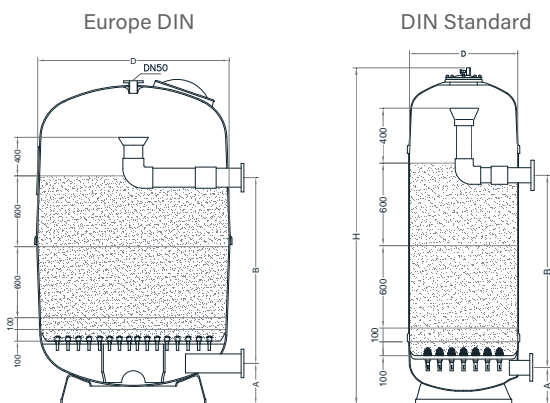

Multilayer - Outlet water under nozzle plate.

		DIN Standard				Europe DIN			
Monolayer (1 sight glass)	Outlet water above nozzle plate	66033 126 000	66034 126 000	66035 126 000	66036 126 000	66037 126 000	66038 126 000	66039 126 000	66040 126 000
	Outlet water under nozzle plate	66033 126 000	66034 126 000	66035 126 000	66036 126 000	66685 126 000	66686 126 000	66687 126 000	66688 126 000
Multilayer (2 sight glasses)	Outlet water above nozzle plate	66033 127 000	66034 127 000	66035 127 000	66036 127 000	66037 127 000	66038 127 000	66039 127 000	66040 127 000
	Outlet water under nozzle plate	66033 127 000	66034 127 000	66035 127 000	66036 127 000	66685 127 000	66686 127 000	66687 127 000	66688 127 000
Ø (mm)		650	800	1000	1200	1400	1600	1800	2000
Filtration velocity (m ³ /h/m ²)		20 / 30	20 / 30	20 / 30	20 / 30	20 / 30	20 / 30	20 / 30	20 / 30
Flow (m ³ /h)		7 / 10	10 / 15	16 / 23	23 / 34	31 / 46	40 / 60	51 / 76	63 / 94
H (mm)		2411	2442	2617	2752	2650	2738	2800	2880
A (mm)	Outlet water above nozzle plate	-	-	-	-	915	915	915	960
	Outlet water under nozzle plate	270	270	355	385	400	400	400	400
B (mm)	Outlet water above nozzle plate	-	-	-	-	1000	1000	1000	1000
	Outlet water under nozzle plate	1400	1400	1400	1400	1400	1400	1400	1400
D (mm)		668	818	1033	1234	1440	1640	1840	2040
Input connection (mm)		90	110	140	160	160	160	200	200
Output connection (mm)		75	90	110	140	140	160	160	200
MULTILAYER	1 st layer) Gravel 3 - 5 mm (kg)	50	80	120	175	240	310	395	485
	2 nd layer) Gravel 2 - 3 mm (kg)	50	80	120	175	240	310	395	485
	3 rd layer) Sand 0.4 - 0.8 mm (kg)	270	407	635	915	1245	1630	2060	2545
	4 th layer) Anthracite 0.6 - 1.6 mm (l)	160	240	375	540	740	965	1220	1508
SINGLE LAYER	Sand 0,7 -1.2 mm (kg)	535	815	1270	1830	2495	3255	4120	5090
	Gravel 2 - 3 mm (kg)	50	80	120	175	240	310	395	485
	Grade 1 glass load (57011) (kg)	305	470	730	1050	1430	1865	2360	2915
	Grade 2 glass load (57012) (kg)	100	155	240	340	470	610	770	950
		110	170	260	380	515	670	850	1050

Vic filters



Filtration bed
1 m

Maximum pressure:
2.5 kg/cm².

Does not include valve manifold

For filters with nozzle plates, a side opening (Ø 400 mm or Ø 225 mm) should be made for emptying the filter medium.

Optional:
Standard American sizes

NB: Technical features in accordance with the table on the following page

DESCRIPTION

Industrial bobbin wound filters with diameters from 1050 mm to 3000 mm, with the corresponding flange connections for different filtration velocities. Replaces the Atenas model. New top cover system with quick closing system 400 x 500 mm opening. The air relief valve is fitted into the cover in order to help eliminate air from the filter. 1½" collector arms injected in ABS at the necessary lengths for each of the filters and without joints. Lengths from 90 mm to 525 mm. A reduced head loss is achieved thanks to the greater diameter of the arms.

The 90 mm diameter collector tubing is injected in PVC. Water purge and air relief are faster due to a 1" connection. The distance between the top sand layer and the diffuser head ("freeboard") has been increased to ensure greater water distribution during filtration and to prevent sand entering into the laterals during the backwashing.

In the case of filters with diameters of 2350 mm, 2500 mm and 3000 mm, the top cover is Ø 400 mm that screws into place and has a PRFV high resistance neck ring. The 200 mm, 225 mm and 250 mm connections are in PVC and the foot is plain, both of which are features very similar to the Oslo and Prague models.

Diameter Ø mm	Filtration velocity m ³ /h/m ²	Outlet Ø mm	Flow rate m ³ /h	Code	Standard Pack	Standard weight in kg	Standard volume in m ³
1050	20	63	17	11511N	1	120	1.9
1050	30-40	75	25-34	11517N	1	120	1.9
1050	50	90	43	11526N	1	120	1.9
1200	20-30	75	22-33	11512N	1	154	2.7
1200	40-50	90	45-56	11522N	1	154	2.7
1400	20	75	30	11513N	1	173	3.7
1400	30	90	46	11518N	1	173	3.7
1400	40-50	110	61-77	11523N	1	173	3.7
1600	20	90	40	11514N	1	235	5.0
1600	30-40	110	60-80	11519N	1	235	5.0
1600	50	125	100	11527N	1	235	5.0
1800	20	90	50	11515N	1	270	6.4
1800	30	110	76	11520N	1	270	6.4
1800	40	125	101	11524N	1	270	6.4
1800	50	140	125	11528N	1	270	6.4
2000	20	110	62	11516N	1	295	8.7
2000	30	125	94	11521N	1	295	8.7
2000	40	140	125	11525N	1	295	8.7
2000	50	160	157	11529N	1	295	8.7



Filter base



Collector arms

Vic filters



Filtration bed
1 m

Does not include valve
manifold

For filters with nozzle
plates, a side opening
(Ø 400 mm or Ø 225 mm)
should be made for
emptying the filter
medium.

Optional:
Standard American sizes

TECHNICAL FEATURES

Code 2.5 kg	Ø filter mm	A mm	B mm	C mm	H mm	Ø P mm	Ø flange mm	Filtration surface area (m ²)
11511N	1050	685	85	535	1950	760	63	0.86
11517N	1050	685	85	535	1950	760	75	0.86
11526N	1050	685	85	535	1950	760	90	0.86
11512N	1200	680	85	530	1970	860	75	1.13
11522N	1200	680	85	530	1970	860	90	1.13
11513N	1400	685	85	575	2000	1020	75	1.54
11518N	1400	685	85	575	2000	1020	90	1.54
11523N	1400	685	85	575	2000	1020	110	1.54
11514N	1600	695	85	625	2050	1150	90	2.01
11519N	1600	695	85	625	2050	1150	110	2.01
11527N	1600	695	85	625	2050	1150	125	2.01
11515N	1800	710	85	670	2080	1320	90	2.54
11520N	1800	710	85	670	2080	1320	110	2.54
11524N	1800	710	85	670	2080	1320	125	2.54
11528N	1800	710	85	670	2080	1320	140	2.54
11516N	2000	730	85	715	2150	1470	110	3.14
11521N	2000	730	85	715	2150	1470	125	3.14
11525N	2000	730	85	715	2150	1470	140	3.14
11529N	2000	730	85	715	2150	1470	160	3.14



Filter base

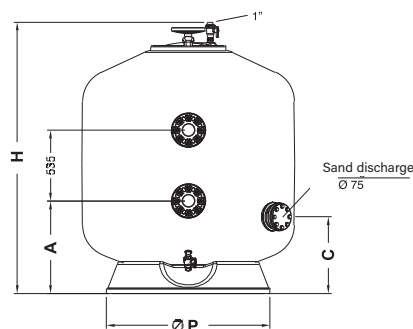
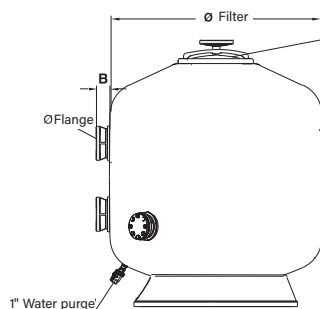

Collector arms

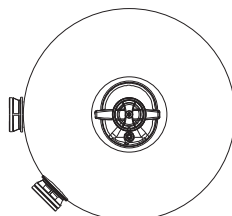

Type	Ø	1050	1200	1400	1600	1800	2000
Single-layer collector arms	Sand load (kg)	950	1375	1650	2150	2800	3800
	Gravel load (kg)	300	300	450	675	750	1050
	Grade 1 glass load (57011) (kg)	648	872	1091	1465	1844	2519
	Grade 2 glass load (57012) (kg)	212	285	356	479	602	823
	Grade 2 glass load (57012) (kg)	233	313	392	527	663	906
Single-layer nozzle plate	Sand load (kg)	700	1200	1400	1850	2400	3300
	Gravel load (kg)	150	175	250	300	400	500
	Grade 1 glass load (57011) (kg)	442	717	860	1121	1460	1982
	Grade 2 glass load (57012) (kg)	144	234	281	366	477	647
	Grade 2 glass load (57012) (kg)	159	258	309	403	525	173

Praga filters



DESCRIPTION

Polyester and fibreglass single-layer filter Ø400mm lid. Equipped with pressure gauge panel, manual air and water bleed valves and drain plug. Suitable for filtration speeds of 20, 30, 40 and 50 m³/h/m².

For other filtration velocities, please enquire.

Diameter Ø mm	Filtration velocity m ³ /h/m ²	Outlet Ø mm	Flow rate m ³ /h	Code	Standard Pack	Standard weight in kg	Standard volume in m ³
1050	20	63	17	00687	1	120	2.45
1050	30-40	75	25-34	00694	1	120	2.45
1050	50	90	43	00707	1	120	2.45
1200	20-30	75	22-33	00688	1	155	3.38
1200	40-50	90	45-56	00702	1	155	3.38
1400	20	75	30	00689	1	198	4.75
1400	30	90	46	00696	1	198	4.75
1400	40	110	61	00703	1	198	4.75
1600	20	90	40	00690	1	255	6.13
1600	30-40	110	60-80	00697	1	255	6.13
1600	50	125	100	00710	1	255	6.13
1800	20	90	50	00691	1	285	7.25
1800	30	110	76	00698	1	285	7.25
1800	40	125	101	00705	1	285	7.25
1800	50	140	125	00711	1	285	7.25
1800	50	160	125	33312	1	285	7.25
2000	20	110	62	00692	1	355	9.92
2000	30	125	94	00699	1	355	9.92
2000	40	140	125	00706	1	355	9.92
2000	50	160	157	05083	1	355	9.92
2200	30	140	114	56937	1	450	13.9
2200	40	160	152	56938	1	450	13.9
2350	20	125	87	00693	1	500	17.04
2350	30	140	130	00700	1	500	17.04
2350	40	160	175	04935	1	500	17.04
2500	20	140	100	08695	1	750	19.5
2500	30	160	150	08696	1	750	19.5
2500	40	200	200	08697	1	750	19.5
3000	20	160	140	08699	1	1340	29.0
3000	30	200	212	08700	1	1340	29.0
3000	40	225	282	08701	1	1340	29.0

**Filtration bed
1 m**

**Maximum pressure:
2.5 kg/cm².**

**Does not include valve
manifold**

**For filters with nozzle
plates, a side opening (Ø
400 mm or Ø 225 mm)
should be made for
emptying the filter
medium.**

**Optional:
Standard American sizes**

**OTHER SPECIFIC
DEPTHS MAY BE MADE
TO ORDER.**

**THE Ø 3000 mm FILTERS
WILL BE SHIPPED BY
SPECIAL DELIVERY.
ASK YOUR DEALER
ABOUT ADDITIONAL
COSTS.**

**Note: See technical
features on next page**

Praga filters



Filtration bed
1 m

Maximum pressure:
4 kg/cm²

Does not include valve
manifold

For filters with nozzle
plates, a side opening
(Ø 400 mm or Ø 225 mm)
should be made for
emptying the filter
medium.

Optional:
Standard American sizes

OTHER SPECIFIC
DEPTHS MAY BE MADE
TO ORDER.

DESCRIPTION

Lid Ø 400 mm.

Diameter Ø mm	Filtration velocity m ³ /h/m ²	Outlet Ø mm	Flow rate m ³ /h	Code	Standard Pack	Standard weight in kg	Standard volume in m ³
1050	20	63	17	09209	1	155	2.45
1050	30-40	75	25-34	00712	1	155	2.45
1050	50	90	43	00724	1	155	2.45
1200	20-30	75	22-33	00713	1	215	3.38
1200	40-50	90	45-56	00719	1	215	3.38
1400	20	75	30	09210	1	300	4.75
1400	30	90	46	00714	1	300	4.75
1400	40-50	110	61-77	00720	1	300	4.75
1600	20	90	40	09211	1	330	6.13
1600	30-40	110	60-80	00715	1	330	6.13
1600	50	125	100	00727	1	330	6.13
1800	20	90	50	09212	1	400	7.25
1800	30	110	76	00716	1	400	7.25
1800	40	125	101	00722	1	400	7.25
1800	50	140	125	00728	1	400	7.25
2000	20	110	62	09213	1	475	9.92
2000	30	125	94	00717	1	475	9.92
2000	40	140	125	00723	1	475	9.92
2000	50	160	157	05132	1	475	9.92
2200	30	140	114	57812	1	560	13.9
2200	40	160	152	57813	1	560	13.9
2350	20	125	87	09214	1	630	17.04
2350	30	140	130	09217	1	630	17.04
2350	40	160	175	09220	1	630	17.04
2500	20	140	100	09215	1	930	19.5
2500	30	160	150	09218	1	930	19.5
2500	40	200	200	09221	1	930	19.5
3000	20	160	140	09216	1	1630	29.0
3000	30	200	212	09219	1	1630	29.0
3000	40	225	282	09222	1	1630	29.0

THE Ø 3000 mm FILTERS
WILL BE SHIPPED BY
SPECIAL DELIVERY.
ASK YOUR DEALER
ABOUT ADDITIONAL
COSTS.

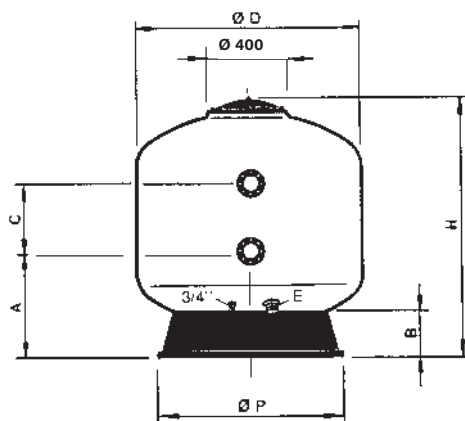

TECHNICAL FEATURES

Ø (mm)	1050	1200	1400	1600	1800	2000	2200	2350	2500	3000
Depth of sand medium (m)	1	1	1	1	1	1	1	1	1	1
H (mm)	1640	1780	1755	1835	1875	2040	2440	2520	2550	2750
B (mm)	200	230	240	260	280	300	340	340	340	350
A (mm)	540	570	585	680	720	790	950	965	1080	1100
C (mm)	645	640	610	515	465	510	510	600	450	440
Ø P (mm)	755	940	1085	1230	1370	1550	1830	1859	2000	2365
E (mm)	90	90	90	140	140	140	140	140	140	140
Filtration surface areas (m ²)	0.86	1.13	1.54	2.01	2.54	3.14	3.80	4.34	4.90	7.07
Volume (l)	1050	1500	2000	2600	3400	4400	6520	8045	9050	12800
Sand load (kg)	950	1375	1650	2150	2800	3800	4650	5275	5950	8600
Gravel load (kg)	300	300	450	675	750	1050	1900	1800	2200	3300
Grade 1 glass load (57011) (kg)	648	872	1091	1465	1844	2519	3388	3667	4220	6160
Grade 2 glass load (57012) (kg)	212	285	356	479	602	823	1107	1198	1378	2012
Grade 2 glass load (57012) (kg)	233	313	392	527	663	906	1218	1319	1518	2215
Total operating weight (kg)	2000	2700	3700	4900	6100	7900	11200	12550	13760	20200

2.5 bar OC-1 Praga filters



Filtration bed
1 m

Maximum pressure:
2.5 kg/cm².

NB: Coding options
according to table on
page 652



OC-1 filtration medium

DESCRIPTION

Filters manufactured with a resin and fibreglass bobbin.

- Maximum working pressure: 2.5 bar
- Maximum temperature: 50°C.
- Height of filter bed: 1 m or 1.2 m
- Colour: RAL 6027.
- Ø400 mm plastic lid.
- Ø¾" manual air bleed valve.
- Special interiors with 3mm slot arms.
- PVC connections.
- Average discharge of Ø90 mm in models Ø1050 to Ø1400 and Ø140 mm in models Ø1600 to Ø3000.
- Ø¾" manual water bleed valve.
- Filter suitable for OC-1 medium only. Not suitable for sand, glass or other type of filtration media.

Diameter Ø mm	Filtration velocity m ³ /h/m ²	Outlet Ø mm	Flow rate m ³ /h	Code	Standard Pack	Standard weight in kg	Standard volume in m ³
1050	20	63	17	00687 OC1	1	286	-
1050	30/40	75	25/34	00694 OC1	1	286	-
1050	50	90	43	00707 OC1	1	286	-
1200	20/30	75	22/33	00688 OC1	1	354	-
1200	40/50	90	45/56	00702 OC1	1	354	-
1400	20	75	30	00689 OC1	1	504	-
1400	30	90	46	00696 OC1	1	504	-
1400	40/50	110	61/77	00703 OC1	1	504	-
1600	20	90	40	00690 OC1	1	600	-
1600	30/40	110	60/80	00697 OC1	1	600	-
1600	50	125	100	00710 OC1	1	600	-
1800	20	90	50	00691 OC1	1	744	-
1800	30	110	76	00698 OC1	1	744	-
1800	40	125	101	00705 OC1	1	744	-
1800	50	140	125	00711 OC1	1	744	-
1800	50	160	125	33312 OC1	1	744	-
2000	20	110	62	00692 OC1	1	997	-
2000	30	125	94	00699 OC1	1	997	-
2000	40	140	125	00706 OC1	1	997	-
2000	50	160	157	05083 OC1	1	997	-

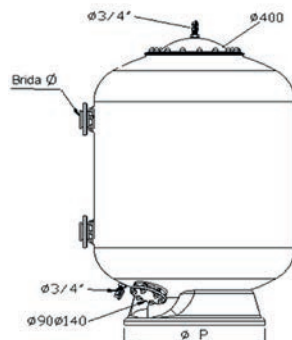
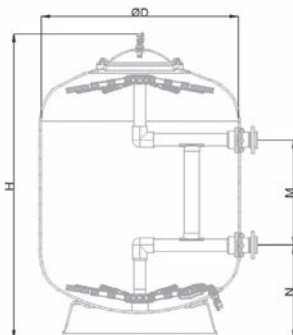

Ø (mm)	1050	1200	1400	1600	1800	2000
H (mm)	1640	1780	1755	1835	1875	2040
M (mm)	645	640	610	515	465	510
N (mm)	540	570	585	680	720	790
P (mm)	755	940	1085	1230	1370	1550
Filtration surface areas (m ²)	0.86	1.13	1.54	2.01	2.54	3.14
OC-1 load (kg)	176	229	319	385	494	667

BOBBIN WOUND FILTERS

Vertical high performance

bobbin wound filters



Oslo

Olot



Does not include valve manifold

**THIS TABLE ONLY
COVERS HIGH
PERFORMANCE OSLO
AND OLOT BOBBIN
WOUND FILTERS**

DESCRIPTION

General features:

- 100% resistant to corrosion unlike conventional steel filters
- Maximum operating temperature 50° C
- Comply with European standards for pressure vessels 97/23/CE included in section 3 of article 3
- Hydraulic pressure test 1.5 times the maximum admissible pressure

Technical features of internal components:

- Internal components and pipe in PVC
- Laterals and nozzles in PP
- Airwash connection in models with underdrain nozzle plates
- Bolts, nuts and washers in AISI-316
- EPDM seals and gaskets.

Advantages of using an underdrain nozzle plate system over the conventional lateral system:

- There are no areas beneath the nozzles for water to stagnate as could occur in a lateral system
- Optimum filter bed back wash with an uniform water distribution
- Possibility of air wash with consequent saving of clean water
- The lateral manhole is recommended for sand discharge

The characteristics of liquids to be filtered should be indicated clearly when requesting ozone or other chemical resistant coatings for the filter interior.

RECOMMENDED SAND, GRAVEL AND GLASS LOADS

SINGLE-LAYER - Collector arms - Filtration bed 1.2 m in depth

Diameter mm		1050	1200	1400	1600	1800	2000	2200	2350	2500	2600	2800	3000
Sand load (kg)		1300	1775	2300	3000	3800	4650	5625	6300	7075	8176	9483	10575
Gravel load (kg)		300	350	500	775	850	1150	1400	1800	1975	2123	2463	3850
Grade 1 glass load (57011) (kg)		832	1107	1457	1961	2419	3015	3651	4205	4699	5351	6207	7471
Grade 2 glass load (57012) (kg)		272	361	476	641	790	985	1193	1373	1535	1748	2027	2440
Grade 2 glass load (57012) (kg)		299	398	524	705	870	1084	1313	1512	1690	1924	2232	2687

MULTI-LAYER - Collector arms - Filtration bed 1.2 m in depth

Diameter mm		1050	1200	1400	1600	1800	2000	2200	2350	2500	2600	2800	3000
Hydroanthracite (0.8-1.6) Kg	600 mm	450	575	775	1000	1275	1575	1900	2175	2450	2548	2956	3550
Sand (0,4-0,8) (Kg)	400 mm	475	625	825	1100	1400	1700	2050	2350	2675	2973	3448	3850
Gravel (1-2) (Kg)	100 mm	150	175	250	300	400	500	600	675	775	796	924	1100
Gravel (2-3) (Kg)	100 mm (1)	300	350	500	775	850	1150	1400	1800	1975	2123	2463	3850

SINGLE-LAYER - Nozzle plate - Filtration bed 1.2 m in depth

Diameter mm		1050	1200	1400	1600	1800	2000	2200	2350	2500	2600	2800	3000
Sand load (kg)		1300	1775	2300	3000	3800	4050	5625	6300	7075	8176	9483	10575
Gravel load (kg)		150	175	250	300	400	500	600	675	775	796	924	1100
Grade 1 glass load (57011) (kg)		757	1019	1332	1725	2195	2376	3253	3645	4102	4690	5441	6102
Grade 2 glass load (57012) (kg)		247	333	435	563	717	776	1063	1191	1340	1532	1777	1993
Grade 2 glass load (57012) (kg)		272	367	479	620	789	845	1170	1311	1475	1687	1957	2194

MULTI-LAYER - Nozzle plate - Filtration bed 1.2 m in depth

Diameter mm		1050	1200	1400	1600	1800	2000	2200	2350	2500	2600	2800	3000
Hydroanthracite (0.8-1.6) Kg	600 mm	450	575	775	1000	1275	1575	1900	2175	2450	2548	2956	3550
Sand (0,4-0,8) (Kg)	400 mm	475	625	825	1100	1400	1700	2050	2350	2675	2973	3448	3850
Gravel (1-2) (Kg)	100 mm	150	175	250	300	400	500	600	675	775	796	924	1100
Gravel (3-5) (Kg)	100 mm	150	175	250	300	400	500	600	675	775	796	924	1100

MULTI-LAYER - Nozzle plate - Filtration bed 1.5 m in depth

Diameter mm		1050	1200	1400	1600	1800	2000	2200	2350	2500	2600	2800	3000
Hydroanthracite (0.8-1.6) Kg	600 mm	450	575	775	1000	1275	1575	1900	2175	2450	2548	2956	3550
Sand (0,4-0,8) (Kg)	600 mm	725	950	1250	1650	2100	2550	3100	3525	4025	4460	5172	5775
Gravel (1-2) (Kg)	100 mm	150	175	250	300	400	500	600	675	775	796	924	1100
Gravel (2-3) (Kg)	100 mm	150	175	250	300	400	500	600	675	775	796	924	1100
Gravel (3-5) (Kg)	100 mm	150	175	250	300	400	500	600	675	775	796	924	1100

Densities: Hydroanthracite = 0.8 Kg/dm³ - Sand = 1.4 Kg/dm³ - Gravel = 1.5 Kg/dm³

(1) 100 mm above laterals

Oslo filters



**Filtration bed
1.2 m**

**Maximum pressure: 2.5
kg/cm².**

**Does not include valve
manifold**

**Optional:
Standard American sizes**

**OTHER SPECIFIC
DEPTHS MAY BE MADE
TO ORDER.**

**THE Ø 3000 mm FILTERS
WILL BE SHIPPED BY
SPECIAL DELIVERY.
ASK YOUR DEALER
ABOUT ADDITIONAL
COSTS.**



Lateral manhole Ø 400 mm



Nozzle plate

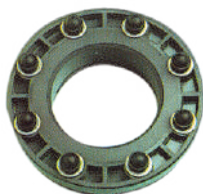

Sightglass

DESCRIPTION

Characteristics:

Vertical high performance bobbin wound filters

Collector system:

A-Conventional collector system using laterals with 0.3 mm slots.

For working pressure of 2.5 and 4 bars.

B-Nozzle plate with 0.5 mm slots. For working pressure of 2.5 and 4 bars.

Fitted with:

- Pressure gauge panel
- Manual air vent and water purge

Options:

- Positioning of water connections flanges, sightglasses and manhole covers are provided according to customer specification.
- Diameters of connections and purges depend on customer specifications
- For other variations such as height, chemical resistant internal coating, pressure rating, etc., please enquire.

Diameter Ø mm	Filtration velocity m ³ /h/m ²	Outlet Ø mm	Flow rate m ³ /h	Code	Standard Pack	Standard weight in kg	Standard volume in m ³
1050	30	75	25	04611	1	207	2.5
1050	40	90	34	04612	1	207	2.5
1200	30	75	33	04613	1	234	3.2
1200	40	110	45	04650	1	234	3.2
1400	30	90	46	04615	1	294	4.7
1400	40	125	61	04616	1	294	4.7
1600	30	110	60	04619	1	360	6.2
1600	40	140	80	04651	1	360	6.2
1800	30	125	76	04623	1	416	8.5
1800	40	160	101	04624	1	416	8.5
2000	30	125	94	04626	1	483	10.3
2000	40	160	125	04652	1	483	10.3
2200	30	140	114	56935	1	567	14.8
2200	40	160	152	56936	1	567	14.8
2350	30	140	130	08693	1	651	15.8
2350	40	200	175	08694	1	651	15.8
2500	30	160	150	08704	1	820	20.8
2500	40	225	200	08706	1	820	20.8
3000	30	200	212	08708	1	1300	31.0
3000	40	250	282	08710	1	1300	31.0

Oslo filters



**Filtration bed
1.2 m**

**Maximum pressure:
4 kg/cm²**

**Optional:
Standard American sizes**

**LARGE FILTERS OF
MORE THAN 2500 mm
WILL BE SHIPPED BY
SPECIAL DELIVERY. ASK
YOUR DEALER ABOUT
ADDITIONAL COSTS.**

**For filters with nozzle
plates, a side opening
(Ø 400 mm or Ø 225 mm)
should be made for
emptying the filter
medium.**

**NB: Coding options
according to table on
page 652**

Diameter Ø mm	Filtration velocity m ³ /h/m ²	Outlet Ø mm	Flow rate m ³ /h	Code	Standard Pack	Standard weight in kg	Standard volume in m ³
1050	30	75	25	05168	1	230	2.5
1050	40	90	34	05173	1	230	2.5
1200	30	75	33	05169	1	265	3.2
1200	40	110	45	05174	1	265	3.2
1400	30	90	46	07436	1	364	4.7
1400	40	125	61	07437	1	364	4.7
1600	30	110	60	05170	1	442	6.2
1600	40	140	80	05175	1	442	6.2
1800	30	125	76	07438	1	518	8.5
1800	40	160	101	07439	1	518	8.5
2000	30	125	94	05171	1	644	10.3
2000	40	160	125	05176	1	644	10.3
2200	30	140	114	57810	1	715	14.8
2200	40	160	152	57811	1	715	14.8
2350	30	140	130	05172	1	786	15.8
2350	40	200	175	05177	1	786	15.8
2500	30	160	150	08712	1	964	20.8
2500	40	225	200	08714	1	964	20.8
3000	30	200	212	08716	1	1613	31.0
3000	40	250	282	08718	1	1613	31.0

TECHNICAL FEATURES

Type	Multi-layer collector arms					Multi-layer nozzle plate				
	Sand load (kg)	Gravel load kg	Grade 1 glass load (57011) kg	Grade 2 glass load (57012) kg	Grade 3 glass load (57013) kg	Sand load (kg)	Gravel load kg	Grade 1 glass load (57011) kg	Grade 2 glass load (57012) kg	Grade 3 glass load (57013) kg
1050	1300	300	832	272	299	1300	150	757	247	272
1200	1775	350	1107	361	398	1775	175	1019	333	367
1400	2300	500	1457	476	524	2300	250	1332	435	479
1600	3000	775	1961	641	705	3000	300	1725	563	620
1800	3800	850	2419	790	870	3800	400	2195	717	789
2000	4650	1150	3015	985	1084	4050	500	2376	776	845
2200	5625	1400	3651	1193	1313	5625	600	3253	1063	1170
2350	6300	1800	4205	1373	1512	6300	675	3645	1191	1311
2500	7075	1975	4699	1535	1690	7075	775	4102	1340	1475
3000	10575	3850	7471	2440	2687	10575	1100	6102	1993	2194

Oslo filters

TECHNICAL FEATURES

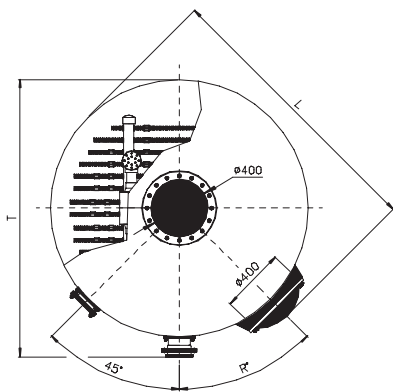
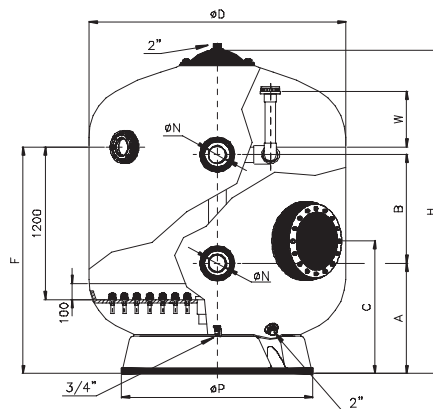
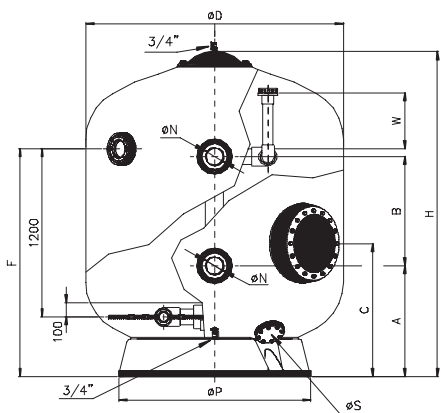

Oslo collector arms

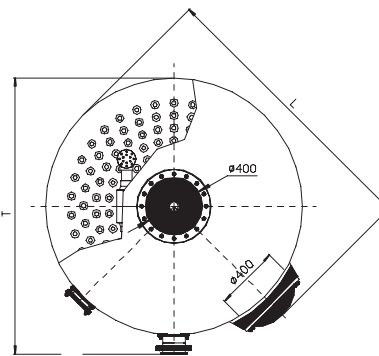

Oslo nozzle plate

Ø D (mm)	Filtration velocity (m³/h/m²)	Ø N (mm)	2,5 bar		4 bar		Flow rate m³/h	Filtration area (m²)	Volume (l)	A (mm)	B (mm)	C (mm)	F (mm)	H (mm)	L (mm)	Ø P (mm)	R	Ø S (mm)	T (mm)	W (mm)	Total operating weight (kg)
			Code	Code	Code	Code															
1050	30	75	DN65	04611	05168	25	0.86	1500	650	940	770	1550	2070	1240	750	55°	90	1220	325	2450	
	40	90	DN80	04612	05173	34															
1200	30	75	DN65	04613	05169	33	1.13	1860	670	830	770	1550	2080	1390	940	45°	90	1380	350	3000	
	40	110	DN100	04650	05174	45															
1400	30	90	DN80	04615	07436	46	1.54	2700	680	820	840	1570	2175	1590	1085	45°	90	1570	350	4300	
	40	125	DN110	04616	07437	61															
1600	30	110	DN100	04619	05170	60	2.01	3620	780	800	870	1625	2310	1790	1230	45°	140	1780	400	5825	
	40	140	DN125	04651	05175	80															
1800	30	125	DN110	04623	07438	76	2.54	4725	790	780	950	1625	2320	1990	1370	45°	140	2000	400	7300	
	40	160	DN150	04624	07439	101															
2000	30	125	DN110	04626	05171	94	3.14	5800	790	840	950	1695	2460	2190	1550	45°	140	2200	400	9000	
	40	160	DN150	04652	05176	125															
2200	30	140	DN125	56935	57810	114	3.80	7080	960	700	1100	1750	2580	2390	1860	45°	140	2400	450	12500	
	40	160	DN150	56936	57811	152															
2350	30	140	DN125	08693	05172	130	4.34	8800	1065	700	1130	1850	2720	2550	1860	45°	140	2550	500	13750	
	40	200	DN175	08694	05177	175															
2500	30	160	DN150	08704	08712	150	4.90	9850	1125	450	1080	1760	2750	2700	2000	45°	140	2750	500	14885	
	40	225	DN200	08706	08714	200															
3000	30	200	DN175	08708	08716	212	7.07	15350	1150	600	1140	1870	2950	3200	2365	45°	140	3200	500	21615	
	40	250	DN225	08710	08718	282															

Olot filters



**Filtration bed
1.2 m and 1.5 m**

**Maximum pressure:
2 kg/cm²**

**Does not include valve
manifold**

**Optional:
Standard American sizes**

**THE Ø 3000 mm FILTERS
WILL BE SHIPPED BY
SPECIAL DELIVERY.
ASK YOUR DEALER
ABOUT ADDITIONAL
COSTS.**

**NB: Coding options
according to table on
page 652**

DESCRIPTION

Features:

According to DIN 19605/19643 Standard

Collector system:

Nozzle plate with 0.5 mm slots, working pressure 2.5 bar.

Fitted with:

- Pressure gauge panel
- Manual air vent and water purge
- Air wash connection flange
- Ø 400 mm manhole

Options:

- Positioning of water connections flanges, sightglasses and manhole covers are provided according to customer specification.
- Diameters of connections and purges depend on customer specifications
- For other variations such as height, chemical resistant internal coating, pressure rating, etc., please enquire.

Diameter Ø mm	Filtration velocity m ³ /h/m ²	Outlet Ø mm	Flow rate m ³ /h	Code	Standard Pack	Standard weight in kg	Standard volume in m ³
Filtration bed 1.2 m							
1050	30	110	25	07355	1	265	2.95
1200	30	125	33	07356	1	345	3.86
1400	30	140	46	07447	1	380	5.22
1600	30	160	60	07357	1	420	7.09
1800	30	200	76	07448	1	470	9.09
2000	30	225	94	07358	1	540	11.25
2200	30	225	114	56934	1	-	15.34
2350	30	250	130	07359	1	825	16.20
2500	30	250	150	19335	1	940	24.40
2600	30	250	160	23969	1	1021	25.21
2800	30	250	185	23970	1	1135	29.50
3000	30	250	212	19336	1	1425	30.00
Filtration bed 1.5 m							
1050	30	110	25	18227	1	285	3.21
1200	30	125	33	18228	1	385	4.20
1400	30	140	46	18229	1	420	5.68
1600	30	160	60	18230	1	460	7.69
1800	30	200	76	18231	1	515	9.58
2000	30	225	94	18232	1	625	12.90
2350	30	250	130	18233	1	920	17.50
2500	30	250	150	19337	1	1010	25.87
2600	30	250	160	23971	1	1144	26.51
2800	30	250	185	23972	1	1264	30.63
3000	30	250	212	19338	1	1590	32.12

Olot filters

TECHNICAL FEATURES

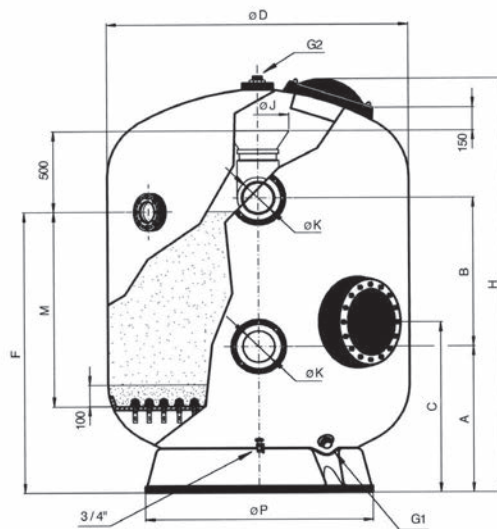
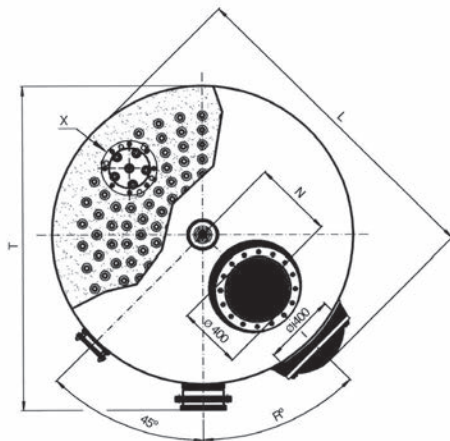

		Ø D (mm)	1050	1200	1400	1600	1800	2000	2200	2350	2500	2600	2800	3000
Filtration velocity (m ³ /h/m ²)			30	30	30	30	30	30	30	30	30	30	30	30
Ø K (mm)			110	125	140	160	200	225	225	250	250	250	250	250
			DN100	DN110	DN125	DN150	DN175	DN200	DN200	DN225	DN225	DN225	DN225	DN225
FILTER BED 1.2 m	Code		07355	07356	07447	07357	07448	07358	56934	07359	19335	23969	23970	19336
	H (mm)		2380	2400	2420	2520	2570	2660	2690	2800	2850	2920	3030	2900
	F (mm)		1615	1635	1645	1690	1740	1750	1820	1870	1870	1880	1920	1880
	Vol. (l)		1735	2175	3000	4350	5450	6650	7930	9575	11700	12800	15500	18000
	Total operating weight (kg)		2600	3325	4475	6250	7500	9625	11815	13600	15500	16650	19500	22500
FILTER BED 1.5 m	Code		18227	18228	18229	18230	18231	18232	65547	18233	19337	23971	23972	19338
	H (mm)		2680	2700	2720	2820	2870	2960	2990	3100	3150	3220	3330	3200
	F (mm)		1915	1935	1945	1990	2040	2050	2120	2170	2170	2180	2220	2180
	Vol (l)		1995	2745	3590	5150	6350	7650	9070	11255	12950	14100	16900	19700
	Total operating weight (kg)		3000	3900	5300	7150	8750	11250	13130	15800	17950	19400	22600	26250
Flow rate (m ³ /h)			25	33	46	60	76	94	114	130	150	160	185	212
Filtration area (m ²)			0,86	1,13	1,54	2,01	2,54	3,14	3,80	4,34	4,90	5,31	6,16	7,07
Number of injectors			59	78	102	134	168	200	200	286	333	333	381	433
A (mm)			700	700	830	830	900	950	950	1050	1100	1160	1230	1140
B (mm)			1000	1000	900	950	920	760	750	680	600	600	650	600
C (mm)			830	840	840	870	950	950	1130	1130	1100	1200	1230	1220
L (mm)			1240	1390	1600	1810	1990	2194	2390	2550	2720	2800	3000	3220
Ø P (mm)			730	940	1080	1230	1390	1550	1860	1850	2050	2050	2200	2360
T (mm)			1220	1380	1570	1780	2000	2240	2450	2630	2750	2800	3000	3270
N (mm)			0	130	130	400	450	480	520	550	700	600	600	720
Ø X sightglass (mm)			125	250	250	250	250	250	250	250	250	250	250	250
° R			55°	45°	45°	45°	45°	45°	45°	45°	45°	45°	45°	45°
Ø J (mm)			380	380	380	380	380	380	380	600	600	600	600	600
Ø G1			2"	2"	2"	2"	75	75	75	75	75	90	110	140
Ø G2*			2"	2"	2"	2"	2"	2"	75	75	75	75	75	75

* In models Ø 1050 mm, 1200 mm and 1400 mm, this fitting is fitted on to the cover.

Construction features

of the filter according to DIN 18820

DESCRIPTION



- (1) Chemical protective gel-coat barrier isoneopenligical type CSS-UP3.

Superior hardness and resistance to the abrasion of sand and salt water. Complies with German standard KTW recommendations and certified by LVHT.

The optional vinylester layer for protection against ozone is of the CCS-PHAS class.

- (2) Polyester reinforced laminated resin with randomly orientated fibreglass filament GF-UP1type.

- Reinforced in MW areas under greater stress with an additional woven matting, alternating non-aligned (4) with aligned fibres (3).

- A set of radial bobbin layers (5) (7) on the cylindrical part and a set of polar layers (6) along the entire filter body with type GF-UP1 made with numeric control machinery. The most essential feature of these filters is their mechanical resistance which enables them to withstand greater internal pressures.

- All filters are submitted to a seasoning process at a temperature of 60°C.

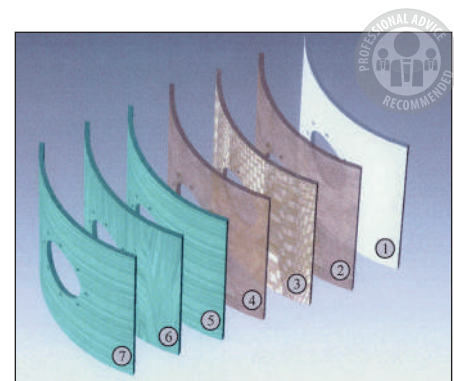
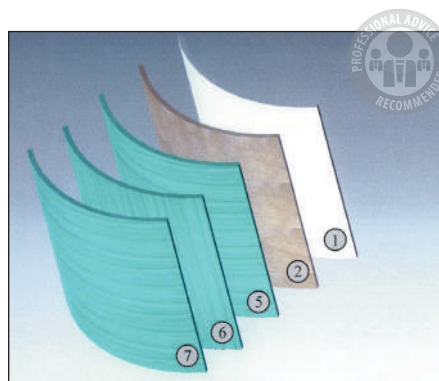

Rodas filters

Ø 1050 mm and Ø 1200 mm



DESCRIPTION

General features:

- 100% resistant to corrosion unlike conventional steel filters
- Excellent relation between filter weight and its mechanical characteristics
- Maximum operating temperature 50° C
- Comply with European standards for pressure vessels 97/23/CE included in section 3 of article 3
- Hydraulic pressure test 1.5 times the maximum admissible pressure
- Resistance and thickness calculations are based on norms BS-4994 and AD Merkblatt N1

Fitted with:

- Pressure gauge panel
- Manual air vent and water purge
- Ø 400 mm lateral manhole and Ø 140 mm top port

Characteristics of internal components:

- Internal components and pipe in PVC
- PP laterals with 0.3 slots
- Bolts, nuts and washers in AISI-316
- EPDM seals and gaskets

Ø 1050 mm
Ø 1200 mm

Rodas filters

Ø 1050 mm and Ø 1200 mm



**Filter bed
depth 0.6 m**

**Ø 1050 mm
Ø 1200 mm**

**Maximum pressure:
2.5 kg/cm²**

**See the sand, gravel and
glass media loads on the
next page**

Length Ø mm	Filtration velocity m ³ /h/m ²	Outlet Ø mm	Flow rate m ³ /h	Code	Standard Pack	Standard weight in kg	Standard volume in m ³
Ø 1050 mm filters							
1900	20	75	34	05102	1	230	2.95
1900	30	90	52	05105	1	230	2.95
1900	40	110	69	05108	1	230	2.95
2300	20	110	42	11331	1	280	3.57
2300	30	125	64	11332	1	280	3.57
2300	40	140	85	11333	1	280	3.57
2500	20	110	46	24842	1	305	3.88
2500	30	125	70	24843	1	305	3.88
2500	40	140	93	24844	1	305	3.88
2700	20	110	50	11334	1	330	4.20
2700	30	125	75	11335	1	330	4.20
2700	40	140	100	11336	1	330	4.20
3000	20	110	56	22647	1	370	4.67
3000	30	140	84	22648	1	370	4.67
3000	40	160	112	22649	1	370	4.67
Ø 1200 mm filters							
1900	20	110	39	22650	1	270	3.08
1900	30	125	59	22651	1	270	3.08
1900	40	140	79	22652	1	270	3.08
2300	20	110	48	22653	1	330	3.73
2300	30	140	73	22654	1	330	3.73
2300	40	160	97	22655	1	330	3.73
2500	20	125	53	24845	1	360	4.05
2500	30	140	79	24846	1	360	4.05
2500	40	160	106	24847	1	360	4.05
2700	20	125	57	22656	1	390	4.38
2700	30	140	86	22657	1	390	4.38
2700	40	160	115	22658	1	390	4.38
3000	20	125	64	22659	1	435	4.86
3000	30	140	96	22660	1	435	4.86
3000	40	160	129	22661	1	435	4.86

Rodas filters

Ø 1050 mm and Ø 1200 mm

 Filter bed
depth 0.6 m

 Ø 1050 mm
Ø 1200 mm

 Maximum pressure:
4 kg/cm²

Length Ø mm	Filtration velocity m ³ /h/m ²	Outlet Ø mm	Flow rate m ³ /h	Code	Standard Pack	Standard weight in kg	Standard volume in m ³
Ø 1050 mm filters							
1900	20	75	34	07124	1	270	2.95
1900	30	90	52	07125	1	270	2.95
1900	40	110	69	07126	1	270	2.95
2300	20	110	42	11321	1	330	3.57
2300	30	125	64	11322	1	330	3.57
2300	40	140	85	11323	1	330	3.57
2500	20	110	46	25016	1	355	3.88
2500	30	125	70	25017	1	355	3.88
2500	40	140	93	25018	1	355	3.88
2700	20	110	50	11326	1	380	4.20
2700	30	125	75	11327	1	380	4.20
2700	40	140	100	11328	1	380	4.20
3000	20	110	56	22683	1	420	4.67
3000	30	140	84	22684	1	420	4.67
3000	40	160	112	20895	1	420	4.67
Ø 1200 mm filters							
1900	20	110	39	22685	1	310	3.08
1900	30	125	59	22686	1	310	3.08
1900	40	140	79	22687	1	310	3.08
2300	20	110	48	22688	1	375	3.73
2300	30	140	73	22689	1	375	3.73
2300	40	160	97	20897	1	375	3.73
2500	20	125	53	25019	1	410	4.05
2500	30	140	79	25020	1	410	4.05
2500	40	160	106	25021	1	410	4.05
2700	20	125	57	22690	1	440	4.38
2700	30	140	86	22691	1	440	4.38
2700	40	160	115	20898	1	440	4.38
3000	20	125	64	22692	1	480	4.86
3000	30	140	96	22693	1	480	4.86
3000	40	160	129	20899	1	480	4.86

TECHNICAL FEATURES

Filter length (mm)	Ø 1050 filters					Ø 1200 filters				
	1900	2300	2500	2700	3000	1900	2300	2500	2700	3000
Sand load (kg)	950	1250	1525	1800	2250	1100	1425	1750	2075	2325
Gravel load (kg)	350	475	575	700	775	425	550	700	825	925
Grade 1 glass load (57011) (kg)	673	893	1087	1294	1568	789	10022	1268	1501	1682
Grade 2 glass load (57012) (kg)	220	292	355	423	512	258	334	414	490	549
Grade 2 glass load (57012) (kg)	242	321	391	465	564	284	368	456	540	605

Rodas filters \varnothing 1050 mm and \varnothing 1200 mm

TECHNICAL FEATURES

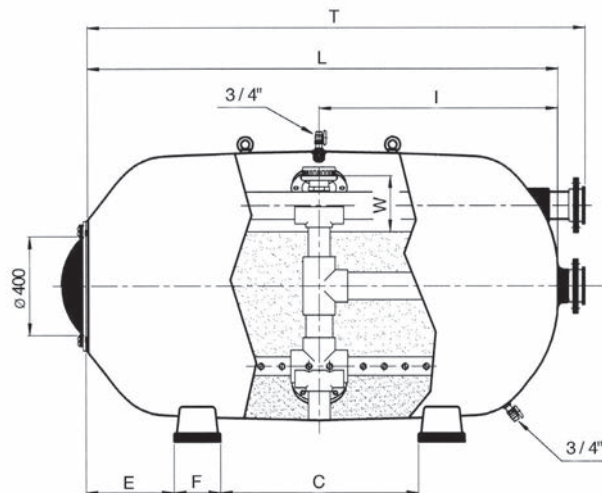
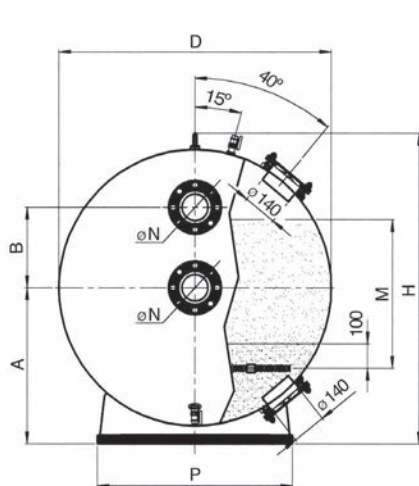

Length (mm)	Filtration velocity $m^3/h/m^2$	\varnothing N (mm)	2,5 bar		4 bar		Flow rate m^3/h	Filtration area (m^2)	Volume (l)	A (mm)	B (mm)	C (mm)	E (mm)	F (mm)	H (mm)	I (mm)	P (mm)	T (mm)	W (mm)	Total operating weight (kg)	Sand load	
			Code	Code	1-1,2 mm	0,4 - 0,8 mm																
Diameter 1050 mm - Filter bed depth 0.6 m.																						
1900	20	75	DN65	05102	07124	34	1,72	1480	630	325	760	380	190	1260	950	800	2160	170	2530	350	950	
	30	90	DN80	05105	07125	52																
	40	110	DN100	05108	07126	69																
2300	20	110	DN100	11331	11321	42	2,12	1820	630	325	1000	460	190	1260	1150	800	2560	170	3100	475	1250	
	30	125	DN110	11332	11322	64																
	40	140	DN125	11333	11323	85																
2500	20	110	DN100	24842	25016	46	2,32	2000	630	325	1120	500	190	1260	1250	800	2760	170	3380	575	1525	
	30	125	DN110	24843	25017	70																
	40	140	DN125	24844	25018	93																
2700	20	110	DN100	11334	11326	50	2,51	2170	630	325	1240	540	190	1260	1350	800	2960	170	3670	700	1800	
	30	125	DN110	11335	11327	75																
	40	140	DN125	11336	11328	100																
3000	20	110	DN100	22647	22683	56	2,81	2430	630	325	1420	600	190	1260	1500	800	3260	170	4100	775	20250	
	30	140	DN125	22648	22684	84																
	40	160	DN150	22649	20895	112																
Diameter 1200 mm - Filter bed depth 0.6 m.																						
1900	20	75	DN100	22650	22685	39	1,96	1900	725	325	760	380	200	1390	950	900	2130	225	3220	425	1100	
	30	90	DN110	22651	22686	59																
	40	110	DN125	22652	22687	79																
2300	20	110	DN100	22653	22688	48	2,42	2350	725	325	1000	460	200	1390	1150	900	2530	225	3960	550	1425	
	30	125	DN125	22654	22689	73																
	40	140	DN150	22655	20897	97																
2500	20	110	DN110	24845	25019	53	2,65	2580	725	325	1120	500	200	1390	1250	900	2750	225	4320	700	1750	
	30	125	DN125	24846	25020	79																
	40	140	DN150	24847	25021	106																
2700	20	110	DN110	22656	22690	57	2,87	2800	725	325	1240	540	200	1390	1350	900	2950	225	4690	825	2075	
	30	125	DN125	22657	22691	86																
	40	140	DN150	22658	20898	115																
3000	20	110	DN110	22659	22692	64	3,21	3140	725	325	1420	600	200	1390	1500	900	3250	225	5240	925	2325	
	30	140	DN125	22660	22693	96																
	40	160	DN150	22661	20899	129																

Media recommendations - Sand = 1.4 Kg/dm³ - Gravel = 1.5 Kg/dm³

BOBBIN WOUND FILTERS

Rodas filters

Ø 1400 mm and Ø 1600 mm



**Filtration bed
0.8 and 1 m**

**Ø 1400 mm
Ø 1600 mm
Ø 1800 mm**

**Maximum pressure:
2.5 kg/cm².**

**Does not include
Valve manifold**

**Optional:
Standard American sizes**

**See the sand, gravel and
glass loads on page 675**

DESCRIPTION

General features:

- 100% resistant to corrosion unlike conventional steel filters
- Maximum operating temperature 50° C
- Comply with European standards for pressure vessels 97/23/CE included in section 3 of article 3
- Hydraulic pressure test 1.5 times the maximum admissible pressure

Fitted with:

- Pressure gauge panel
- Manual air vent and water purge
- Ø 400 mm lateral manhole

Characteristics of internal components:

- Internal components and pipe in PVC
- PP laterals with 0.3 slots
- Bolts, nuts and washers in AISI-316
- EPDM seals and gaskets.

Length Ø mm	Filtration velocity m ³ /h/m ²	Outlet Ø mm	Flow rate m ³ /h	Code	Standard Pack	Standard weight in kg	Standard volume in m ³
Ø 1400 mm filters							
Filtration bed 0.8 m							
1900	20	110	45	24848	1	340	4.84
1900	30	125	67	24849	1	340	4.84
1900	40	140	89	24850	1	340	4.84
2500	20	110	60	24854	1	435	6.23
2500	30	140	91	24855	1	435	6.23
2500	40	160	121	24856	1	435	6.23
3000	20	125	73	24860	1	530	7.44
3000	30	160	110	24861	1	530	7.44
3000	40	200	147	24862	1	530	7.44
Ø 1600 mm filters							
Filtration bed 1 m							
1900	20	110	49	22662	1	400	5.49
1900	30	140	74	22663	1	400	5.49
1900	40	160	99	22664	1	400	5.49
2500	20	140	67	24866	1	520	7.18
2500	30	160	101	24867	1	520	7.18
2500	40	200	134	24868	1	520	7.18
3000	20	140	82	22671	1	620	8.60
3000	30	160	123	22672	1	620	8.60
3000	40	200	164	22673	1	620	8.60

Rodas filters

Ø 1400 mm, Ø 1600 mm and Ø 1800 mm



Length Ø mm	Filtration velocity m ³ /h/m ²	Outlet Ø mm	Flow rate m ³ /h	Code	Standard Pack	Standard weight in kg	Standard volume in m ³
----------------	--	----------------	--------------------------------	------	------------------	--------------------------	--------------------------------------

Ø 1800 mm filters

Filtration bed 1 m

Maximum pressure: 2.5 kg/cm²

Filtration bed 0.8 and 1 m	2500	20	125	75	24875	1	585	10.40
	2500	30	160	112	24876	1	585	10.40
Ø 1400 mm Ø 1600 mm Ø 1800 mm	2500	40	200	150	24877	1	585	10.40
	3000	20	140	92	24881	1	700	12.25
	3000	30	160	137	24882	1	700	12.25
	3000	40	200	183	24883	1	700	12.25
	3500	20	140	108	24887	1	875	14.20
	3500	30	200	162	24888	1	875	14.20
Does not include Valve manifold	3500	40	225	216	24889	1	875	14.20
	4000	20	160	125	24893	1	930	16.00
	4000	30	200	187	24894	1	930	16.00
	4000	40	225	250	24895	1	930	16.00

Ø 1400 mm filters

Filtration bed 0.8 m

Maximum pressure: 4 kg/cm²

**Optional:
Standard American sizes**

**See the sand, gravel and
glass media loads on the
next page**

	1900	20	110	45	25022	1	385	4.84
	1900	30	125	67	25023	1	385	4.84
	1900	40	140	89	25024	1	385	4.84
	2500	20	110	60	25028	1	485	6.23
	2500	30	140	91	25029	1	485	6.23
	2500	40	160	121	25030	1	485	6.23
	3000	20	125	73	25034	1	585	7.44
	3000	30	160	110	25035	1	585	7.44
	3000	40	200	147	25036	1	585	7.44

BOBBIN WOUND FILTERS

Rodas filters

Ø 1400 mm, Ø 1600 mm and Ø 1800 mm



**Filtration bed
0.8 and 1 m**

**Ø 1400 mm
Ø 1600 mm
Ø 1800 mm**

**Maximum pressure:
4 kg/cm².**

**Does not include
Valve manifold**

**Optional:
Standard American sizes**

Length Ø mm	Filtration velocity m ³ /h/m ²	Outlet Ø mm	Flow rate m ³ /h	Code	Standard Pack	Standard weight in kg	Standard volume in m ³
Ø 1600 mm filters							
Filtration bed 1 m							
1900	20	110	49	22694	1	450	5.49
1900	30	140	74	22695	1	450	5.49
1900	40	160	99	20900	1	450	5.49
2500	20	140	67	25040	1	570	7.18
2500	30	160	101	25041	1	570	7.18
2500	40	200	134	25042	1	570	7.18
3000	20	140	82	22700	1	685	8.60
3000	30	160	123	22701	1	685	8.60
3000	40	200	164	20903	1	685	8.60
Ø 1800 mm filters							
Filtration bed 1 m							
2500	20	125	75	25049	1	680	10.40
2500	30	160	112	25050	1	680	10.40
2500	40	200	150	25051	1	680	10.40
3000	20	140	92	25055	1	805	12.25
3000	30	160	137	25056	1	805	12.25
3000	40	200	183	25057	1	805	12.25
3500	20	140	108	25061	1	930	14.20
3500	30	200	162	25062	1	930	14.20
3500	40	225	216	25063	1	930	14.20
4000	20	160	125	25067	1	1055	16.00
4000	30	200	187	25068	1	1055	16.00
4000	40	225	250	25069	1	1055	16.00

TECHNICAL FEATURES

Filter length (mm)	Ø 1400 filters			Ø 1600 filters			Ø 1800 filters			
	1900	2500	3000	1900	2500	3000	2500	3000	3500	4000
Sand load (kg)	2100	2825	3450	2850	3875	4750	4850	5925	7000	8075
Gravel load (kg)	575	800	1000	600	850	1050	975	1225	1475	1700
Grade 1 glass load (57011) (kg)	1389	1882	2310	1796	2458	3018	3033	3722	4411	5087
Grade 2 glass load (57012) (kg)	454	615	754	586	803	986	991	1216	1441	1662
Grade 2 glass load (57012) (kg)	500	677	831	646	884	1085	1091	1338	1586	1830

Rodas filters \varnothing 1400 mm, \varnothing 1600 mm and \varnothing 1800 mm

TECHNICAL FEATURES

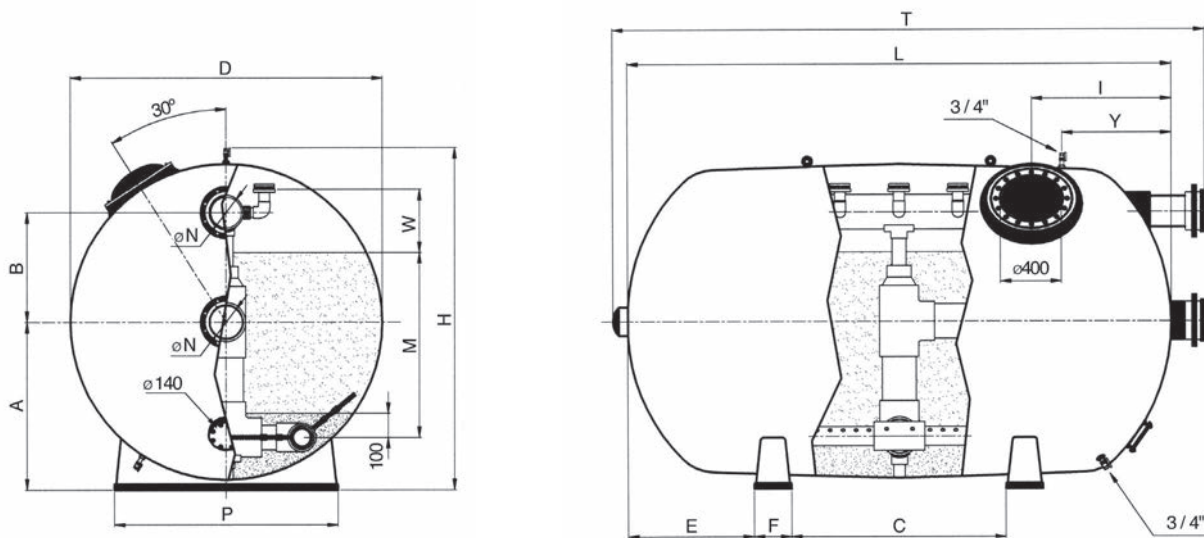

Length (mm)	Filtration velocity $m^3/h/m^2$	\varnothing N (mm)	2,5 bar Code	4 bar Code	Flow rate m^3/h	Filtration area (m^2)	Volume (l)	A (mm)	B (mm)	C (mm)	E (mm)	F (mm)	H (mm)	I (mm)	P (mm)	T (mm)	W (mm)	Y (mm)	Total operating weight (kg)	Sand load		
																				1 - 1.2 mm	0.4 - 0.8 mm	
Diameter 1400 mm - Filter bed depth 0.8-1.2 m																						
1900	20	110	DN100	24848	25022	45	2.23	2530	810	390	720	380	210	1600	820	1080	2160	220	1380	4250	575	2100
	30	125	DN110	24849	25023	67																
	40	140	DN125	24850	25024	89																
2500	20	110	DN100	24854	25028	60	3.02	3460	810	390	1080	500	210	1600	820	1080	2780	220	1380	5740	800	2825
	30	140	DN125	24855	25029	91																
	40	160	DN150	24856	25030	121																
3000	20	125	DN110	24860	25034	73	3.67	4230	810	390	1380	600	210	1600	820	1080	3320	220	1380	6990	1000	3450
	30	160	DN150	24861	25035	110																
	40	200	DN175	24862	25036	147																
Diameter 1600 mm - Filter bed depth 1-1.2 m																						
1900	20	110	DN100	22662	22694	49	2.47	3220	925	475	470	475	240	1830	800	1230	2220	250	1380	5420	600	2850
	30	140	DN125	22663	22695	74																
	40	160	DN150	22664	20900	99																
2500	20	140	DN125	24866	25040	67	3.36	4430	925	475	1020	500	240	1830	800	1230	2820	250	1380	7400	850	3875
	30	160	DN150	24867	25041	101																
	40	200	DN175	24868	25042	134																
3000	20	140	DN125	22671	22700	82	4.1	5430	925	475	1320	600	240	1830	800	1230	3360	250	1380	9020	1050	4750
	30	160	DN150	22672	22701	123																
	40	200	DN175	22673	20903	164																
Diameter 1800 mm - Filter bed depth 1-1.2 m																						
2500	20	125	DN110	24875	25049	75	3.74	5530	1040	550	1020	380	270	2050	870	1380	2820	350	1250	9170	975	4850
	30	160	DN150	24876	25050	112																
	40	200	DN175	24877	25051	150																
3000	20	140	DN125	24881	25055	92	4.58	6800	1040	550	1320	460	270	2050	870	1380	3320	350	1500	11230	1225	5925
	30	160	DN150	24882	25056	137																
	40	200	DN175	24883	25057	183																
3500	20	140	DN125	24887	25061	108	5.41	8070	1040	550	1620	500	270	2050	870	1380	3850	350	1750	13290	1475	7000
	30	200	DN175	24888	25062	162																
	40	225	DN200	24889	25063	216																
4000	20	160	DN150	24893	25067	125	6.25	9340	1040	550	1920	540	270	2050	870	1380	4350	350	2000	15350	1700	8075
	30	200	DN175	24894	25068	187																
	40	225	DN200	24895	25069	250																

Media recommendations - Sand = 1.4 Kg/dm³ - Gravel = 1.5 Kg/dm³

BOBBIN WOUND FILTERS

Rodas filters

Ø 2000 mm and Ø 2350 mm



Filtration bed
1 and 1.2 m

Ø 2000 mm
Ø 2350 mm

Does not include
Valve manifold

Optional:
Standard American sizes

See the sand, gravel and
glass loads on page 679

DESCRIPTION

General features:

- 100% resistant to corrosion unlike conventional steel filters
- Maximum operating temperature 50° C
- Comply with European standards for pressure vessels 97/23/CE included in section 3 of article 3
- Hydraulic pressure test 1.5 times the maximum admissible pressure

Fitted with:

- Pressure gauge panel
- Manual air vent and water purge
- Ø 400 mm lateral manhole

Characteristics of internal components:

- Internal components and pipe in PVC
- PP laterals with 0.3 slots
- Bolts, nuts and washers in AISI-316
- EPDM seals and gaskets.

Length Ø mm	Filtration velocity m ³ /h/m ²	Outlet Ø mm	Flow rate m ³ /h	Code	Standard Pack	Standard weight in kg	Standard volume in m ³
Ø 2000 mm filters							
Maximum pressure: 2.5 kg/cm²							
2500	20	140	87	05103	1	650	13.20
2500	30	160	130	05106	1	650	13.20
2500	40	200	174	05109	1	650	13.20
3000	20	140	106	24899	1	775	15.65
3000	30	160	159	24900	1	775	15.65
3000	40	200	212	24901	1	775	15.65
3500	20	160	125	05104	1	900	18.10
3500	30	200	187	05107	1	900	18.10
3500	40	225	250	05110	1	900	18.10
4000	20	160	144	24908	1	1025	20.55
4000	30	200	216	24909	1	1025	20.55
4000	40	225	288	24910	1	1025	20.55
4500	20	200	163	24914	1	1150	23.00
4500	30	225	245	24915	1	1150	23.00
4500	40	250	326	24916	1	1150	23.00

Rodas filters

Ø 2000 mm and Ø 2350 mm



**Filtration bed
1 and 1.2 m**

**Ø 2000 mm
Ø 2350 mm**

**Does not include
Valve manifold**

**Optional:
Standard American sizes**

**See the sand, gravel and
glass media loads on the
next page**

Length Ø mm	Filtration velocity m ³ /h/m ²	Outlet Ø mm	Flow rate m ³ /h	Code	Standard Pack	Standard weight in kg	Standard volume in m ³
Ø 2350 mm filters							
Maximum pressure: 2.5 kg/cm²							
3000	20	160	119	24917	1	1350	20.25
3000	30	200	178	24918	1	1350	20.25
3000	40	225	238	24919	1	1350	20.25
3500	20	160	141	17120	1	1500	23.00
3500	30	200	212	16696	1	1500	23.00
3500	40	225	282	17121	1	1500	23.00
4000	20	200	163	24926	1	1650	25.75
4000	30	225	245	24927	1	1650	25.75
4000	40	250	327	24928	1	1650	25.75
4500	20	200	186	22674	1	1800	28.50
4500	30	225	279	22675	1	1800	28.50
4500	40	250	371	22676	1	1800	28.50
5000	20	200	208	24935	1	1950	31.25
5000	30	250	312	24936	1	1950	31.25
5000	40	350	416	24937	1	1950	31.25

Ø 2000 mm filters

Maximum pressure: 4 kg/cm²

2500	20	140	87	07127	1	795	13.20
2500	30	160	130	07128	1	795	13.20
2500	40	200	174	07129	1	795	13.20
3000	20	140	106	25073	1	945	15.65
3000	30	160	159	25074	1	945	15.65
3000	40	200	212	25075	1	945	15.65
3500	20	160	125	07130	1	1100	18.10
3500	30	200	187	07131	1	1100	18.10
3500	40	225	250	07132	1	1100	18.10
4000	20	160	144	25082	1	1260	20.55
4000	30	200	216	25083	1	1260	20.55
4000	40	225	288	25084	1	1260	20.55
4500	20	200	163	25088	1	1420	23.00
4500	30	225	245	25089	1	1420	23.00
4500	40	250	326	25090	1	1420	23.00

BOBBIN WOUND FILTERS

Rodas filters

Ø 2000 mm and Ø 2350 mm



**Filtration bed
1 and 1.2 m**

**Ø 2000 mm
Ø 2350 mm**

**Does not include
Valve manifold**

**Optional:
Standard American sizes**

	Length Ø mm	Filtration velocity m ³ /h/m ²	Outlet Ø mm	Flow rate m ³ /h	Code	Standard Pack	Standard weight in kg	Standard volume in m ³
Ø 2350 mm filters								
Maximum pressure: 4 kg/cm²								
	3000	20	160	119	25091	1	1150	20.25
	3000	30	200	178	25092	1	1150	20.25
	3000	40	225	238	25093	1	1150	20.25
	3500	20	160	141	22702	1	1300	23.00
	3500	30	200	212	22703	1	1300	23.00
	3500	40	225	282	22704	1	1300	23.00
	4000	20	200	163	25100	1	1450	25.75
	4000	30	225	245	25101	1	1450	25.75
	4000	40	250	327	25102	1	1450	25.75
	4500	20	200	186	22705	1	1600	28.50
	4500	30	225	279	22706	1	1600	28.50
	4500	40	250	371	22707	1	1600	28.50
	5000	20	200	208	25109	1	1750	31.25
	5000	30	250	312	25110	1	1750	31.25
	5000	40	350	416	25111	1	1750	31.25

TECHNICAL FEATURES										
Filter length (mm)	Ø 2000 filters					Ø 2350 filters				
	2500	3000	3500	4000	4500	3000	3500	4000	4500	5000
Sand load (kg)	6575	8025	9475	10925	12375	9300	11050	12800	14525	16250
Gravel load (kg)	1050	1300	1550	1800	2075	2575	3125	3650	4200	4750
Grade 1 glass load (57011) (kg)	3976	4862	5748	6634	7533	6166	7359	8540	9720	10900
Grade 2 glass load (57012) (kg)	1299	1588	1877	2167	2460	2014	2404	2789	3175	3560
Grade 3 glass load (57013) (kg)	1430	1748	2067	2386	2709	2218	2647	3071	3495	3920

Rodas filters \varnothing 2000 mm and \varnothing 2350 mm

TECHNICAL FEATURES

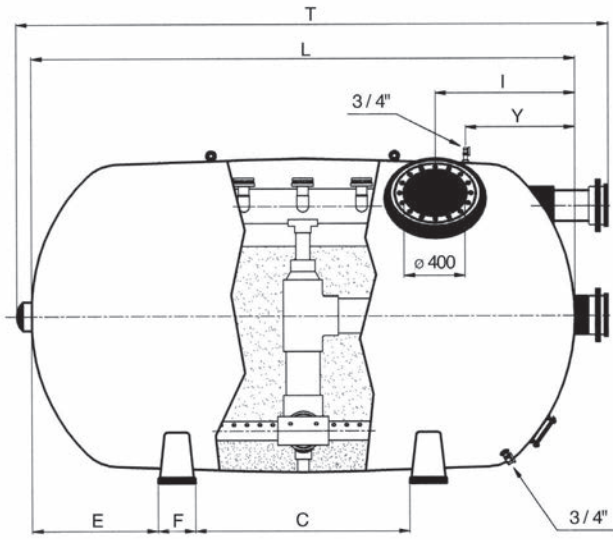
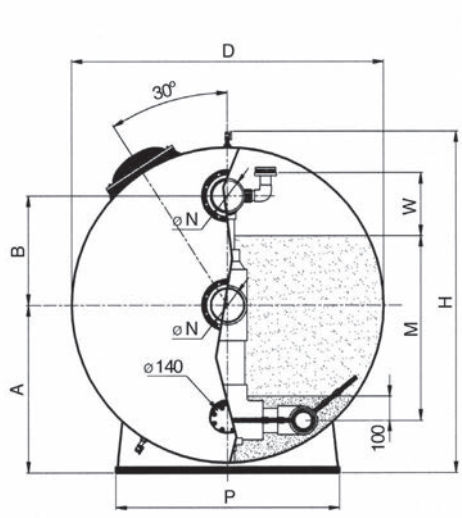

Length (mm)	Filtration velocity (m ³ /h/m ²)	Ø N (mm)	Pressure		Flow rate (m ³ /h)	Filtration area (m ²)	Volume (l)	A (mm)	B (mm)	*C (mm)	E (mm)	F (mm)	H (mm)	I (mm)	P (mm)	T (mm)	W (mm)	Y (mm)	Total operating weight (kg)	Sand load		
			2.5 bar Code	4 bar Code																Granulometry 1-1.2 mm	Granulometry 0.4-0.8 mm	
Diameter 2000 mm - Filter bed depth 1-1.2 m																						
2500	20	140	DN125	05103	07127	87	4.34	6900	1090	710	500	500	500	2220	925	1470	2820	410	1250	11300	1050	6575
	30	160	DN150	05106	07128	130															M=1.2	M=1.2
	40	200	DN175	05109	07129	174															m	m
3000	20	140	DN125	24899	25073	106	5.3	8470	1090	710	810	600	500	2220	925	1470	3320	410	1500	13790	1300	8025
	30	160	DN150	24900	25074	159															M=1.2	M=1.2
	40	200	DN175	24901	25075	212															m	m
3500	20	160	DN150	05104	07130	125	6.25	10040	1090	710	1070	725	500	2220	925	1470	3850	410	1750	16280	1550	9475
	30	200	DN175	05107	07131	187															M=1.2	M=1.2
	40	225	DN200	05110	07132	250															m	m
4000	20	160	DN150	24908	25082	144	7.21	11600	1090	710	650	600	500	2220	925	1470	4350	410	2000	18780	1800	10925
	30	200	DN175	24909	25083	216															M=1.2	M=1.2
	40	225	DN200	24910	25084	288															m	m
4500	20	200	DN175	24914	25088	163	8.16	13180	1090	710	795	600	500	2220	925	1470	4880	410	2250	21380	2075	12375
	30	225	DN200	24915	25089	245															M=1.2	M=1.2
	40	250	DN225	24916	25090	326															m	m
Diameter 2350 mm - Filter bed depth 1-1.2 m																						
3000	20	160	DN150	24917	25091	119	5.94	11130	1270	710	800	600	500	2560	925	1740	3350	500	1500	18300	2575	9300
	30	200	DN175	24918	25092	178															M=1.2	M=1.2
	40	225	DN200	24919	25093	238															m	m
3500	20	160	DN150	17120	22702	141	7.06	13300	1270	710	1100	700	500	2560	925	1740	3850	500	1750	21790	3125	11050
	30	200	DN175	16696	22703	212															M=1.2	M=1.2
	40	225	DN200	17121	22704	282															m	m
4000	20	200	DN175	24926	25100	163	8.17	15470	1270	710	650	600	500	2560	925	1740	4380	500	2000	25280	3650	12800
	30	225	DN200	24927	25101	245															M=1.2	M=1.2
	40	250	DN225	24928	25102	327															m	m
4500	20	200	DN175	22674	22705	186	9.28	17640	1270	710	820	700	500	2560	925	1740	4880	500	2250	28880	4200	14525
	30	225	DN200	22675	22706	279															M=1.2	M=1.2
	40	250	DN225	22676	22707	371															m	m
5000	20	200	DN175	24935	25109	208	10.4	19800	1270	710	600	600	500	2560	925	1740	5440	500	2500	32380	4750	16250
	30	250	DN225	24936	25110	312															M=1.2	M=1.2
	40	315	DN250	24937	25111	416															m	m

Media recommendations : Hydroanthracite = 0.8 Kg/dm³ - Sand = 1.4 Kg/dm³ - Gravel = 1.5 Kg/dm³

*With lengths (dimension L) of 4000 mm or more, an additional central support is provided.

Rodas filters Ø 2500 mm



Filtration bed
1 and 1.2 m

Ø 2500 mm

Does not include
Valve manifold

Optional:
Standard American sizes

LARGE FILTERS OF
MORE THAN 3000 mm
WILL BE SHIPPED BY
SPECIAL DELIVERY. ASK
YOUR DEALER ABOUT
ADDITIONAL COSTS.

DESCRIPTION

General features:

- 100% resistant to corrosion unlike conventional steel filters
- Maximum operating temperature 50° C
- Comply with European standards for pressure vessels 97/23/CE included in section 3 of article 3
- Hydraulic pressure test 1.5 times the maximum admissible pressure

Fitted with:

- Pressure gauge panel
- Manual air vent and water purge
- Ø 400 mm lateral manhole

Characteristics of internal components:

- Internal components and pipe in PVC
- PP laterals with 0.3 slots
- Bolts, nuts and washers in AISI-316
- EPDM seals and gaskets.

Length Ø mm	Filtration velocity m ³ /h/m ²	Outlet Ø mm	Flow rate m ³ /h	Code	Standard Pack	Standard weight in kg	Standard volume in m ³
Ø 2500 mm filters							
Maximum pressure: 2,5 kg/cm²							
3500	20	160	149	24938	1	1285	28.00
3500	30	200	223	24939	1	1285	28.00
3500	40	225	297	24940	1	1285	28.00
4000	20	200	172	22677	1	1450	31.80
4000	30	225	258	22678	1	1450	31.80
4000	40	250	345	22679	1	1450	31.80
4500	20	200	196	24947	1	1615	35.55
4500	30	250	294	24948	1	1615	35.55
4500	40	315	392	24949	1	1615	35.55
5000	20	200	220	22680	1	1780	39.30
5000	30	250	329	22681	1	1780	39.30
5000	40	315	439	22682	1	1780	39.30

Ø 2500 mm filters							
Maximum pressure: 4 kg/cm²							
3500	20	160	149	25112	1	1505	28.00
3500	30	200	223	25113	1	1505	28.00
3500	40	225	297	25114	1	1505	28.00
4000	20	200	172	22708	1	1670	31.80
4000	30	225	258	22709	1	1670	31.80
4000	40	250	345	22710	1	1670	31.80
4500	20	200	196	25121	1	1835	35.55
4500	30	250	294	25122	1	1835	35.55
4500	40	315	392	25123	1	1835	35.55
5000	20	200	220	22711	1	2000	39.30
5000	30	250	329	22712	1	2000	39.30
5000	40	315	439	22713	1	2000	39.30

Rodas filters \varnothing 2500 mm

TECHNICAL FEATURES

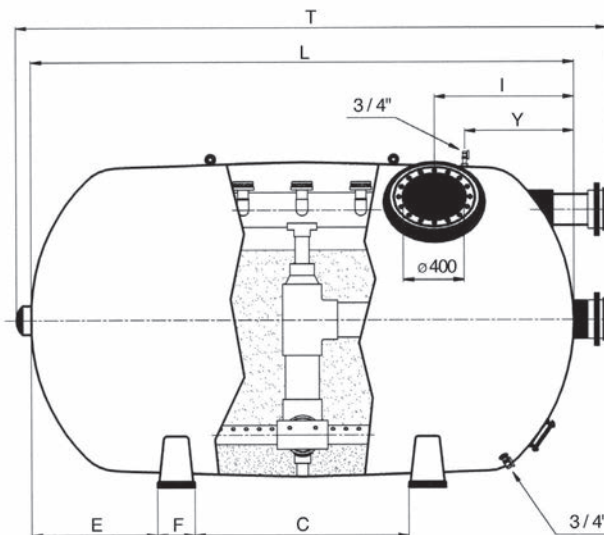
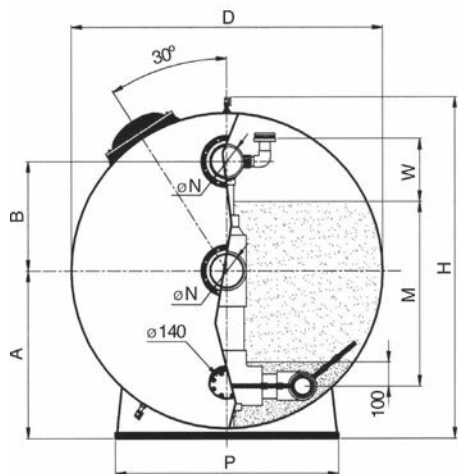

Length (mm)	Filtering velocity (m ³ /h/m ²)	\varnothing N (mm)	2,5 bar	4 bar	Flow rate m ³ /h	Filtration area (m ²)	Volume (l)	A (mm)	B (mm)	*C (mm)	E (mm)	F (mm)	H (mm)	I (mm)	P (mm)	T (mm)	W (mm)	Y (mm)	Total operating weight (kg)	Sand load		
			Code	Code																1 - 1.2 mm	0.4 - 0.8 mm	
Diameter 2500 mm - Filter bed depth 1-1.2 m																						
3500	20	160	DN150	24938	25112	149	7.34	14920	1360	710	960	770	500	2710	1300	1850	3850	500	1750	24320	3175	11675
	30	200	DN175	24939	25113	223															M=1,2	M=1,2
	40	225	DN200	24940	25114	297															m	m
4000	20	200	DN175	22677	22708	172	8.62	17380	1360	710	500	750	500	2710	1300	1850	4380	500	2000	28250	3725	13500
	30	225	DN200	22678	22709	258															M=1,2	M=1,2
	40	250	DN225	22679	22710	345															m	m
4500	20	200	DN175	24947	25121	196	9.80	19830	1360	710	750	750	500	2710	1300	1850	4940	500	2250	32300	4300	15350
	30	250	DN225	24948	25122	294															M=1,2	M=1,2
	40	315	DN250	24949	25123	392															m	m
5000	20	200	DN175	22680	22711	220	10.98	22300	1360	710	500	750	500	2710	1300	1850	5440	500	2500	36230	4850	17200
	30	250	DN225	22681	22712	329															M=1,2	M=1,2
	40	315	DN250	22682	22713	439															m	m

Media recommendations - Sand = 1.4 Kg/dm³ - Gravel = 1.5 Kg/dm³
 *With lengths (dimension L) of 4000 mm or more, an additional central support is provided.

Filter length (mm)	\varnothing 2500 filters			
	3500	4000	4500	5000
Sand load (kg)	11675	13500	15350	17200
Gravel load (kg)	3175	3725	4300	4850
Grade 1 glass load (57011) (kg)	7713	8945	10203	11448
Grade 2 glass load (57012) (kg)	2519	2922	3333	3739
Grade 3 glass load (57013) (kg)	2774	3217	3669	4117

VALVE MANIFOLDS

Valve manifold coding



In order to facilitate sales and prices, a new code system for filter manifolds has been introduced to Catalogues. It consists in assigning a code to each model of manifold as shown in these tables. There is a total of 60 codes and subsequently, in order to determine exactly which filter is being referred to, a system of variations is used, given that the retail price does not vary.

To work out the variation the type and diameter of the filter must be identified, as the output diameters match the manifold code.

For manifolds with more than one filter please consult.



All manifolds are supplied disassembled. All manifolds have to be supported correctly (See brackets on page 686)



Assembly with control box
See page 685



A: Electric driven without safety block
B: Pneumatic driven spring return

Manual or automatically driven valve manifolds made of PVC (PN-10) with flanges for connection to filters as per DIN-2501 standard.

PVC butterfly valves and ball valves.

Automatic valve manifolds, driven either by electric power or pneumatically, for carrying out filtration, backwashing, rinsing and shut down of the filters. Fitted with two valves without safety blocks (electric) or dual action (pneumatic), and the remaining valves with safety blocks (electric) or spring return (pneumatic), to avoid accidentally emptying a pool.

* Ask Cepex Catalogue for automatic ball valves and butterfly valves codes.

TABLE SHOWING FILTER TYPE	
Code	Description
BB	Berlin bobbin wound filter - 0.6 m filter bed (FB)
BS	Praga bobbin wound filter
BA	Oslo bobbin wound filter
OL	Olot bobbin wound filter 1.2 m and 1.5 m filter bed
AM	Ampuria bobbin wound filter 1.2 m and 1.5 m filter bed
HZ	Rodas bobbin wound filter
EU	Europa laminated filter
VP	Vesubio laminated filter - 0.6 m filter bed
VI	Vic bobbin wound filter
VO	Vesubio laminated filter - 1 m filter bed

TABLE SHOWING FILTER DIAMETER	
Code	Diameter
10	1050
12	1200
14	1400
16	1600
18	1800
20	2000
23	2350
25	2500
26	2600
28	2800
30	3000

Examples:

	Code	Var.	Mod.
Manual manifold 4 Val. for Praga filter D.2000-140	1.- 00767	BS	20
Electric manifold 5 Val. for Praga filter D.1800-125	2.- 00785E	BS	18
Manual manifold 5 Val. for Olot filter D.1200-125	3.- 00785	OL	12
Pneumatic manifold 5 Val. for Vic filter D.2350-160	4.- 09177N	VI	23

Valve manifold for one filter



Optional features for manual manifolds:
Standard American sizes

	Code	Standard Pack	Standard weight in kg	Standard volume in m ³
Manual manifolds - 4-way valve				
D. 63	00747	1	-	-
D. 75	00749	1	-	-
D. 90	00754	1	-	-
D. 110	00758	1	-	-
D. 125	00763	1	-	-
D. 140	00767	1	-	-
D. 160	09205	1	-	-
D. 200	09160	1	-	-
D. 225	09164	1	-	-
D. 250	26244	1	-	-
Manual manifolds - 5-way valve				
D. 63	00769	1	-	-
D. 75	00771	1	-	-
D. 90	00776	1	-	-
D. 110	00780	1	-	-
D. 125	00785	1	-	-
D. 140	00789	1	-	-
D. 160	09177	1	-	-
D. 200	09180	1	-	-
D. 225	09185	1	-	-
D. 250	19133	1	-	-
Electric manifolds - 4-way valve				
D. 63	00747E	1	-	-
D. 75	00749E	1	-	-
D. 90	00754E	1	-	-
D. 110	00758E	1	-	-
D. 125	00763E	1	-	-
D. 140	00767E	1	-	-
D. 160	09205E	1	-	-
D. 200	09160E	1	-	-
D. 225	09164E	1	-	-
D. 250	26244E	1	-	-
Electric manifolds - 5-way valve				
D. 63	00769E	1	-	-
D. 75	00771E	1	-	-
D. 90	00776E	1	-	-
D. 110	00780E	1	-	-
D. 125	00785E	1	-	-
D. 140	00789E	1	-	-
D. 160	09177E	1	-	-
D. 200	09180E	1	-	-
D. 225	09185E	1	-	-
D. 250	19133E	1	-	-
Pneumatic manifolds - 4-way valve				
D. 63	00747N	1	-	-
D. 75	00749N	1	-	-
D. 90	00754N	1	-	-
D. 110	00758N	1	-	-
D. 125	00763N	1	-	-
D. 140	00767N	1	-	-
D. 160	09205N	1	-	-
D. 200	09160N	1	-	-
D. 225	09164N	1	-	-
D. 250	26244N	1	-	-
Pneumatic manifolds - 5-way valve				
D. 63	00769N	1	-	-
D. 75	00771N	1	-	-
D. 90	00776N	1	-	-
D. 110	00780N	1	-	-
D. 125	00785N	1	-	-
D. 140	00789N	1	-	-
D. 160	09177N	1	-	-
D. 200	09180N	1	-	-
D. 225	09185N	1	-	-
D. 250	19133N	1	-	-

Valve manifold Control Panel



Overhead PVC pressure pipes should be mounted on supports. The distance between them should be as shown in the table.

Distance between supports in m (according to UNE 53.399).

DESCRIPTION

Control panel for electrically or pneumatically actuated manifolds of 4 or 5 valves. For automatic filtration, backwashing, rinsing and shut-down operations. Fitted with automatic programming installation that enables the execution of all the required operations and can be personalized to suit your requirements. Quick and easy installation with numbered terminal connection strip. Voltage 230 V single phase. Does not include valve manifold.

	Code	Standard Pack	Standard weight in kg	Standard volume in m ³
For 4 valves				
2 valves without block, 2 valves with block. Electric actuator	41005	1	6	0.04
2 valves double acting, 2 valves spring return. Pneumatic actuator	41009	1	6	0.04
For 5 valves				
2 valves without block, 3 valves with block. Electric actuator	41007	1	6	0.04
2 valves double acting, 3 valves spring return. Pneumatic actuator	41011	1	6	0.04

DISTANCE BETWEEN PVC VALVE MANIFOLD SUPPORTS

Ø mm	Rated pressure			
	0.4 MPa	0.6 MPa	1.0 MPa	1.6 MPa
10	-	-	-	0.3
12	-	-	-	0.3
16	-	-	-	0.3
20	-	-	-	0.4
25	-	-	0.5	0.5
32	-	-	0.6	0.6
40	-	0.8	0.8	0.8
50	-	0.9	0.9	0.9
63	1.0	1.0	1.0	1.0
75	1.0	1.0	1.2	1.2
90	1.0	1.2	1.3	1.4
110	1.2	1.3	1.5	1.7
125	1.3	1.5	1.7	1.9
140	1.3	1.6	1.8	2.0
160	1.5	1.7	2.0	2.2
180	1.6	1.8	2.1	2.4
200	1.7	1.9	2.3	2.6
225	1.8	2.1	2.5	2.9
250	1.8	2.2	2.6	3.0
280	2.0	2.3	2.8	3.2
315	2.1	2.5	3.0	3.5
355	2.2	2.7	3.2	3.8
400	2.4	2.8	3.4	4.0
450	2.5	3.0	3.7	4.3
500	2.7	3.2	3.9	4.6

FACTORY PROGRAMMED AUTOMATION AS FOLLOWS

	Actuator types	
	Electric	Pneumatic
For 4 valves	2 valves without block	2 double acting valves
	2 valves with block	2 spring return valves
	Program A	Program C
	Code 41005	Code 41009
	4 valves without block	4 valves without block
	Program A	Program A
For 5 valves	Code 41006	Code 41010
	2 valves without block	2 double acting valves
	3 valves with block	4 spring return valves
	Program B	Program D
	Code 41007	Code 41011
	5 valves without block	5 double acting valves
Program B	Program B	
Code 41008	Code 41012	

These distances are based on a maximum temperature of 20 °C.

In the case of higher temperatures, the values shown should be multiplied by the following reduction coefficients:

- Between 20 and 30 °C, coefficient of 0.9.
- Between 35 and 45 °C, coefficient of 0.85.

In vertical installations, the distance between supports may be as shown in the table multiplied by 1.3.

Valve manifold brackets



DESCRIPTION

Easy assembly valve manifold brackets from Ø 63 mm for all filter types. Totally adjustable in height, consisting of vertical support pipes in zinc-plated steel, together with box of accessories.

	Code	Standard Pack	Standard weight in kg	Standard volume in m ³
Zinc-plated steel				
Height 1.85 m	28690	1	3.8	-
Height 2.30 m	28691	1	4.5	-
Height 3.0 m	28692	1	5.9	-
Box of accessories consisting of: 2 support brackets with anti-vibration clamps, and fixing bolts and accessories				
For Ø 63 mm pipe	42598	1	1.5	0.011
For Ø 75 mm pipe	28693	1	1.5	0.011
For Ø 90 mm pipe	28694	1	1.5	0.011
For Ø 110 mm pipe	28695	1	1.5	0.011
For Ø 125 mm pipe	28696	1	1.5	0.011
For Ø 140 mm pipe	28697	1	1.5	0.011
For Ø 160 mm pipe	28698	1	2.5	0.011
For Ø 200 mm pipe	28699	1	2.5	0.011
For Ø 225 mm pipe	28700	1	2.5	0.011
Accessory box for additional supports:				
Fixing plug and protection cap	28701	1	-	-

Wall brackets for valve manifold



DESCRIPTION

For all filter type from Ø 63 mm pipe onwards. Consisting in zinc-plated steel support bracket with anti-vibration clamp and fixing screws. Supply: 1 vertical support with manifold bracket.

	Code	Standard Pack	Standard weight in kg	Standard volume in m ³
For Ø 63 mm pipe	35585	1	1.0	0.007
For Ø 75 mm pipe	00855	1	1.2	0.007
For Ø 90 mm pipe	00856	1	1.3	0.007
For Ø 110 mm pipe	00857	1	1.4	0.007
For Ø 125 mm pipe	00858	1	1.4	0.007
For Ø 140 mm pipe	00859	1	1.5	0.007
For Ø 160 mm pipe	00860	1	1.6	0.007
For Ø 200 mm pipe	00861	1	1.7	0.007
For Ø 225 mm pipe	00862	1	1.7	0.007
For Ø 250 mm pipe	36120	1	2.0	0.011
For Ø 315 mm pipe	36602	1	2.4	0.011

Air vents



DESCRIPTION

Standard Air vent

In cast Aluminium painted yellow. Inner ball in PVC.

Double effect air vent

Body in PP and fibreglass. Maximum pressure 16 Kg/cm²

Seal in nitrile rubber.

	Code	Standard Pack	Standard weight in kg	Standard volume in m ³
Standard Air vent				
Ø 1"	04143	12	2.3	0.009
Ø 1½"	04144	12	4.0	0.009
Ø 2"	04145	12	4.5	0.018
Double effect air vent				
Ø 1"	49381	1	0.3	0.001
Ø 2" U-bend outlet with PVC elbow	49382	1	0.7	0.001

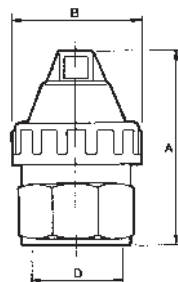

TECHNICAL FEATURES			
Code	D	A (mm)	B (mm)
04143	1"	74	44
04144	1½"	105	69
04145	2"	105	69

FILTRATION MEDIA & ACCESSORIES

OC-1 filtration media



DESCRIPTION

OC-1 filtration load: The future of pool filtration

OC refers to Open Cell and OC-1 is a mechanical filter that uses open-cell filtration technology to filter water with a high quality, increasing the water saving and energy potential. The filtration media is an extruded plastic compound comprising a base of High Density Polyethylene with Calcium Carbonate

Saves water: exclusive filtration method that reduces water consumption by more than 40%

Saves power: lets you use a smaller pump or lower the power to get the same flow you would with traditional filtration media.

Saves time: OC-1 reduces backwash frequency to less than a third of traditional methods, meaning more leisure time for you.

The OC-1 media has been tested in accordance with current European standard EN16713-1.

	Code	Standard Pack	Standard weight in kg	Standard volume in m ³
OC-1 50L filtration media bag	69752	1	9.0	0.05
OC-1 20L filtration media bag	69753	1	3.6	0.02

Active Clear Glass



DESCRIPTION

AstralPool launches the new activated glass filter media Active Clear Glass.

The new product has the following benefits:

- More efficient and environmentally friendly filtration.
- Greater filtration capacity.
- Water and energy savings.
- Cleaner filter bed as bacteria does not remain trapped and fewer chemical products are needed.

	Code	Standard Pack	Standard weight in kg	Standard volume in m ³
Granulometry				
0.5 mm - 1.0 mm	57011	1	25.0	0.667
1.0 mm - 3.0 mm	57012	1	25.0	0.667
3.0 mm - 7.0 mm	57013	1	25.0	0.667

	Code	Range	% Volume of the filter bed	
			Filters D < 900 mm	Filters D > 900 mm
Range1	57011	0.5 - 1.0 mm	0.8	0.6
Range2	57012	1.0 - 3.0 mm	0	0.2
Range3	57013	3,0 - 7,0 mm	0.2	0.2



Silex

DESCRIPTION

Please ask for a quotation for other grades. 25 Kg bag.

	Code	Standard Pack	Standard weight in kg	Standard volume in m ³
Granulometry 0.4 - 0.8 mm	00596	1	25	0.667

Gravel

DESCRIPTION

Please ask for a quotation for other grades. 25 Kg bag.

	Code	Standard Pack	Standard weight in kg	Standard volume in m ³
Granulometry 1 - 2 mm	10697	1	25	0.667
Granulometry 3 - 5 mm	11346	1	25	0.667

Anthracite

DESCRIPTION

Please ask for a quotation for other grades. 50 Kg bag.

	Code	Standard Pack	Standard weight in kg	Standard volume in m ³
Granulometry 0.8 - 1.6 mm	03696	1	50	0.8

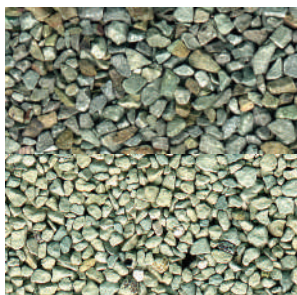

Zeolite

DESCRIPTION

Natural porous material that has higher filtration qualities than the normal substrate. It can be compared to that of diatomaceous earth but at a lower price and lasting much longer. Bags 30 Kg.

	Code	Standard Pack	Standard weight in kg	Standard volume in m ³
Zeolite standard 0.5 - 1 mm	25845	1	-	-
Zeolite standard 1-2 mm	25846	1	30	0.023
Zeolite standard 2-5 mm	25847	1	30	0.023



Gauge panel unit

DESCRIPTION

Including air vents.

	Code	Standard Pack	Standard weight in kg	Standard volume in m ³
With pressure gauges 3 kg/cm ²	00729	1	1	0.007
With pressure gauges 6 kg/cm ²	00730	1	1	0.007



COMMERCIAL POOLS

PUMPS



692 SELF-PRIMING PUMPS

692 Kivu

693 CENTRIFUGAL PUMPS

693 Kivu
694 Colorado with prefilter
695 Colorado without prefilter
696 Maxim
697 Aral C-3000
699 Aral C-1500

701 STRAINERS

701 Strainer in polypropylene and fibreglass
701 Strainer in polyester and fibreglass 33 l capacity
701 Strainer in polyester and fibreglass 60 l capacity
702 Strainer in polyester and fibreglass with sight glass lid 33 l capacity
702 Strainer in polyester and fibreglass with sight glass lid 60 l capacity
703 Kivu strainers
703 Astramax strainers
703 Aral strainers
704 Strainers in stainless steel

705 VALVES AND HOSES

705 Check valves
705 Vibration absorbent brushing

706 AIR BLOWERS

706 Air blowers

Kivu



Optional:
60 Hz pumps (code
XXXX-0810).

DESCRIPTION

High performance plastic self-priming pump for high flow rates (1500 rpm).

- 3 power modes: 3 HP, 4 HP and 5.5 HP.
- Low sound level: as low as 59 dBA.
- Hydraulic efficiency without prefilter 78% (as per ISO 9906 standard).
- High quality mechanical seal for salt water.
- IEC high efficiency motors (IE3).
- Standard motor shaft (compatibility with any pump manufacturer).
- Pump comes with pre-filter (in 2 packages: pump + prefilter).

	Code	Standard Pack	Standard weight in kg	Standard volume in m ³
Kivu 3 HP 230/400V 50Hz + prefilter	66047	1	56.4	0.35
Kivu 3 HP 400/690V 50Hz + prefilter	63042	1	56.4	0.35
Kivu 4 HP 230/400V 50Hz + prefilter	66048	1	59.4	0.35
Kivu 4 HP 400/690V 50Hz + prefilter	63043	1	59.4	0.35
Kivu 5.5 HP 230/400V 50Hz + prefilter	66049	1	66.4	0.35
Kivu 5.5 HP 400/690V 50Hz + prefilter	63044	1	66.4	0.35

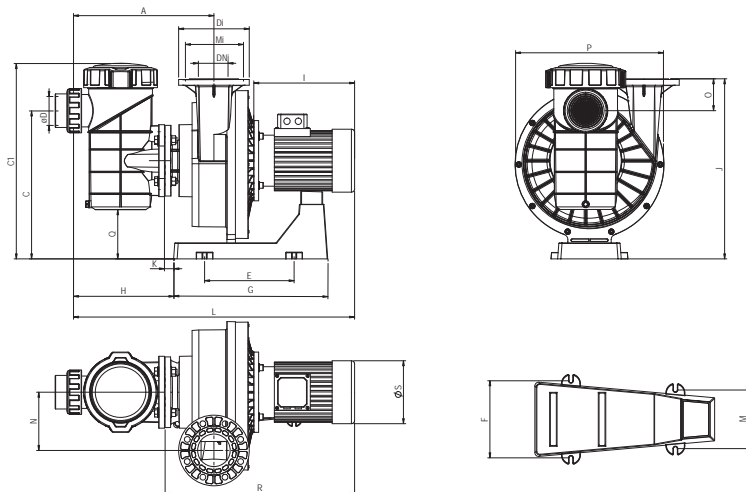

TECHNICAL FEATURES

Code	Power HP	A	D	DI	DNi	C	CI	E	F	G	H	I	J	K	L	M	N	O	P	Q	R	Ma	Mi
		mm																					
63042 66047	3	440	90	220	100 - 4"	462	610	279	206	480	313	320	561	29,5	882	157	181,5	100	460	154	590	-	180
63043 66048	4	440	90	220	100 - 4"	462	610	279	206	480	313	320	561	29,5	882	157	181,5	100	460	154	590	-	180
63044 66049	5,5	440	90	220	100 - 4"	462	610	279	206	480	313	345	561	156	906	157	181,5	100	460	154	621	-	180

PERFORMANCE CURVES WITHOUT PREFILTER

Pressure/Flow rate

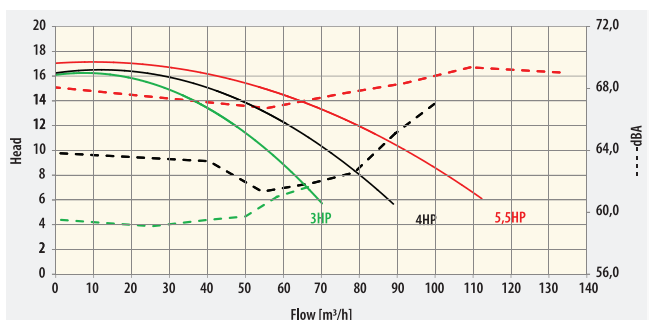

Power/Flow rate

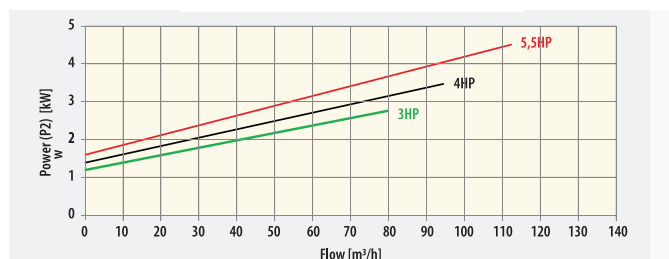

CENTRIFUGAL PUMPS

Kivu



Kivu Pump



Kivu pump
Side view



Optional:
60 Hz pumps (code
XXXX-0810).

DESCRIPTION

High performance plastic centrifugal pump for public pools that works at 1500 rpm.

- 3 power modes: 7.5 HP, 10 HP and 15 HP.
- Low sound level: as low as 66 dBA.
- Hydraulic efficiency without prefilter 85% (9906 ISO standard).
- High quality mechanical seal for salt water.
- IEC high efficiency motors (IE3).
- Standard motor shaft (compatibility with any pump manufacturer).
- Product with GS marking.
- Pump comes with pre-filter (in 2 packages: pump + prefilter).

	Code	Standard Pack	Standard weight in kg	Standard volume in m ³
Kivu 7.5 HP 230/400 V 50Hz + prefilter	56633	1	107.4	0.43
Kivu 7.5 HP 400/690 V 50Hz + prefilter	56634	1	107.4	0.43
Kivu 10 HP 230/400 V 50Hz + prefilter	56635	1	117.9	0.45
Kivu 10 HP 400/690 V 50Hz + prefilter	56637	1	117.9	0.45
Kivu 15 HP 230/400 V 50Hz + prefilter	56638	1	151.2	0.49
Kivu 15 HP 400/690 V 50Hz + prefilter	56639	1	151.2	0.49

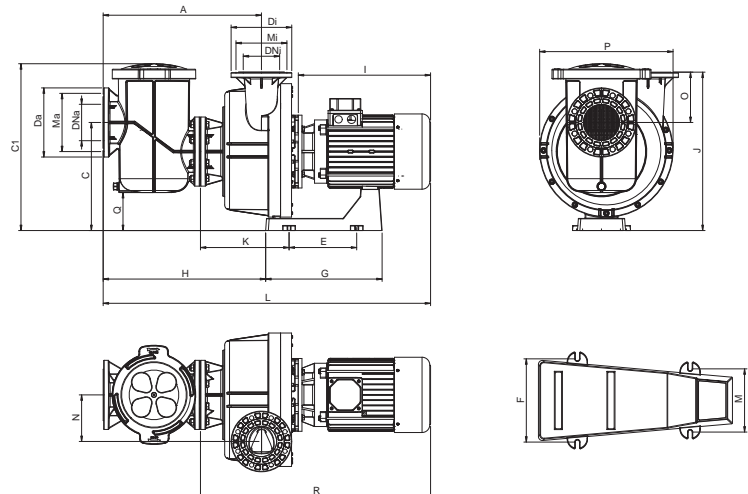

TECHNICAL FEATURES

Code	Power	A	DA	DI	DNA	DNi	C	CI	E	F	G	H	I	J	K	L	M	N	O	P	Q	R	Ma	Mi
	HP	mm																						
56633 56634	7.5	653	285	250	150 - 6"	125 - 5"	446	688	279	206	290	540	410	653	141	1215	157	192	208	550	157	815	240	210
56635 56637	10	653	285	250	150 - 6"	125 - 5"	446	688	279	206	290	540	445	653	141	1250	157	192	208	550	157	850	240	210
56638 56639	15	653	285	250	150 - 6"	125 - 5"	446	688	279	206	290	670	510	653	271	1315	157	192	208	550	157	915	240	210

PERFORMANCE CURVES WITHOUT PREFILTER

Pressure/Flow rate

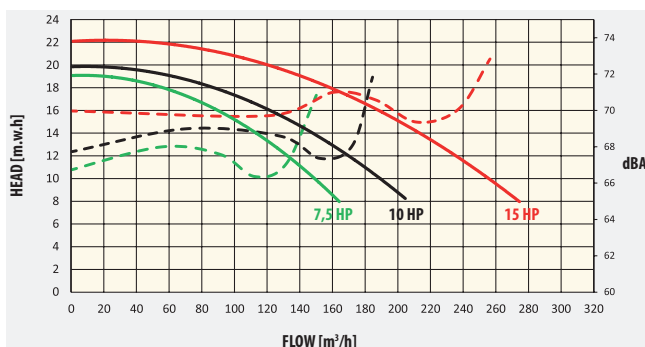

Power/Flow rate

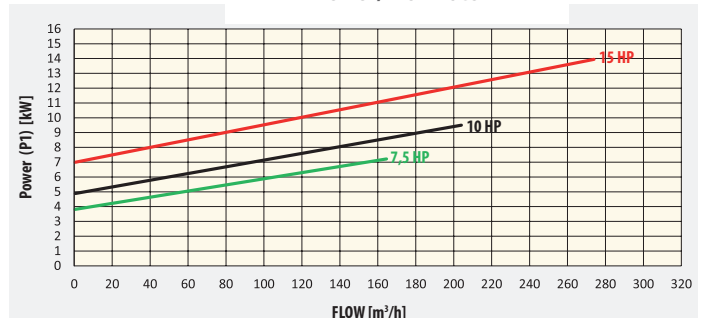

Colorado with prefilter



IE3 version: The same codes with suffix -320

Possibility of placing orders with the following variations:

- bronze turbine
- stainless steel turbine (AISI 316-L).
- Viton mechanical seals.

DESCRIPTION

3000 rpm plastic centrifugal electric pumps with prefilter for pools, perfect for large, low-pressure flow rates. Prefilter with transparent lid and wishbone closure; easy access. Pump bodies and prefilter manufactured in fibreglass-reinforced polypropylene. Plastic turbine. Pump shaft and prefilter basket in stainless steel. IE2 motors with 3000 rpm IP-55 protection at 230/400 V or 400/690 V and 50 Hz. From 4 HP to 12.5 HP.

	Code	Standard Pack	Standard weight in kg	Standard volume in m ³
4 HP, 230/400 V	44706-120	1	56	0.252
5.5 HP, 230/400 V	44707-120	1	56	0.252
7.5 HP, 230/400 V	44708-120	1	57	0.252
7.5 HP, 400/690 V	44709-120	1	57	0.252
10 HP, 230/400 V	44710-120	1	68	0.252
10 HP, 400/690 V	44711-120	1	68	0.252
12.5 HP, 230/400 V	44712-120	1	72	0.252
12.5 HP, 400/690 V	44713-120	1	72	0.252

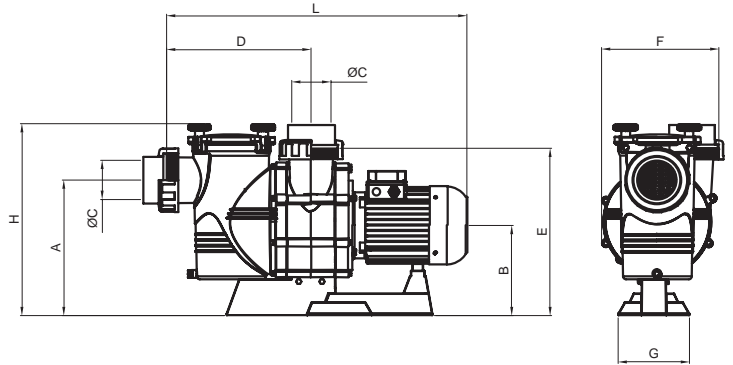

TECHNICAL FEATURES

Code	VOLTAGE (V)	Power		Dimensions (mm)								
		kW	HP	A	B	ØC	D	E	F	G	H	L
44706-120	230/400	2.9	4	375	255	90	405	470	330	200	535	820
44707-120	230/400	4	5.5	375	255	110	405	470	330	200	535	840
44708-120	230/400	5.5	7.5	375	255	110	405	470	330	200	535	840
44709-120	400/690											
44710-120	230/400	7.4	10	375	255	110	405	470	330	200	535	910
44711-120	400/690											
44712-120	230/400	9.2	12.5	375	255	110	405	470	330	200	535	955
44713-120	400/690											

PERFORMANCE CURVES

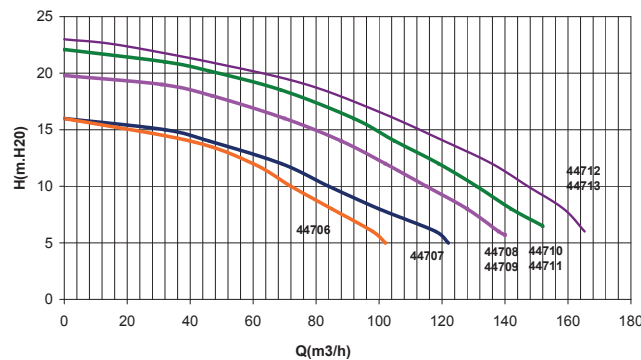

Colorado without prefilter



IE3 version: The same codes with suffix -320

DESCRIPTION

3000 rpm plastic centrifugal electric pumps with no prefilter for pools, perfect for large, low-pressure flow rates. Pump bodies manufactured in fibreglass-reinforced polypropylene. Plastic turbine. Stainless steel pump shaft. IE2 motors with 3000 rpm IP-55 protection at 230/400 V or 400/690 V and 50Hz. From 7.5 HP to 12.5 HP.

	Code	Standard Pack	Standard weight in kg	Standard volume in m ³
4 HP, 230/400 V	44714-120	1	39	0.166
4 HP, 230/400 V	44715-120	1	44	0.166
7.5 HP, 230/400 V	44716-120	1	50	0.166
7.5 HP, 400/690 V	44717-120	1	50	0.166
10 HP, 230/400 V	44718-120	1	61	0.166
10 HP, 400/690 V	44719-120	1	61	0.166
12.5 HP, 230/400 V	44720-120	1	65	0.166
12.5 HP, 400/690 V	44721-120	1	65	0.166

Possibility of placing orders with the following variations:

- bronze turbine
- stainless steel turbine (AISI 316-L).
- Viton mechanical seals.

Available in power modes from 4 to 12.5 HP.

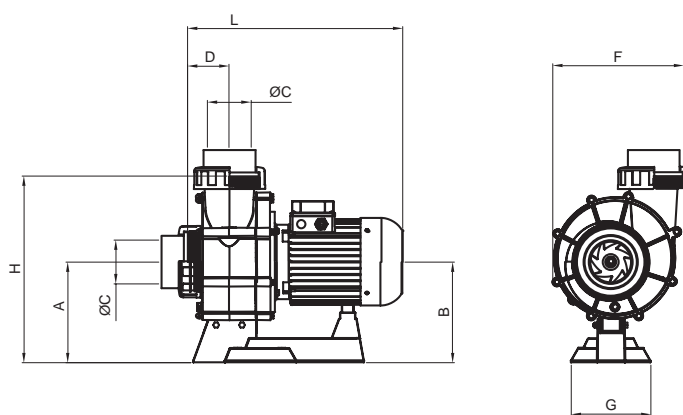

TECHNICAL FEATURES

Code	VOLTAGE (V)	Power		DIMENSIONS (mm)							
		kW	HP	A	B	ØC	D	F	G	H	L
44714-120	230/400	2,9	4	255	255	90	105	330	200	470	510
44715-120	230/400	4	5,5	355	355	110	105	330	200	470	530
44716-120	230/400	5,5	7,5	255	255	110	105	330	200	470	530
44717-120	400/690										
44718-120	230/400	7,4	10	255	255	110	105	330	200	470	600
44719-120	400/690										
44720-120	230/400	9,2	12,5	255	255	110	105	330	200	470	645
44721-120	400/690										

PERFORMANCE CURVES

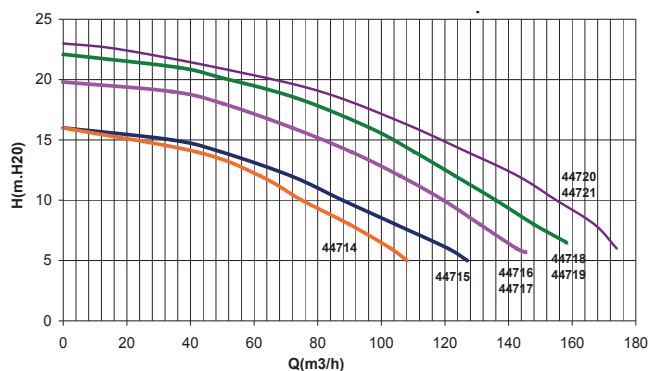

Maxim



DESCRIPTION

Pump body and supports in plastic, AISI-316 stainless steel motor shaft with double insulation. Motor has IP-55 protection rating. Prefilter basket with a capacity of 8 litres. Transparent prefilter lid.



Optional:
60 Hz pumps (code
XXXX-0810).

	Code	Standard Pack	Standard weight in kg	Standard volume in m ³
Maxim 3.5 HP	08003	1	32	0.184
Maxim 4.5 HP	08004	1	34	0.184
Maxim 5.5 HP	08005	1	37	0.184

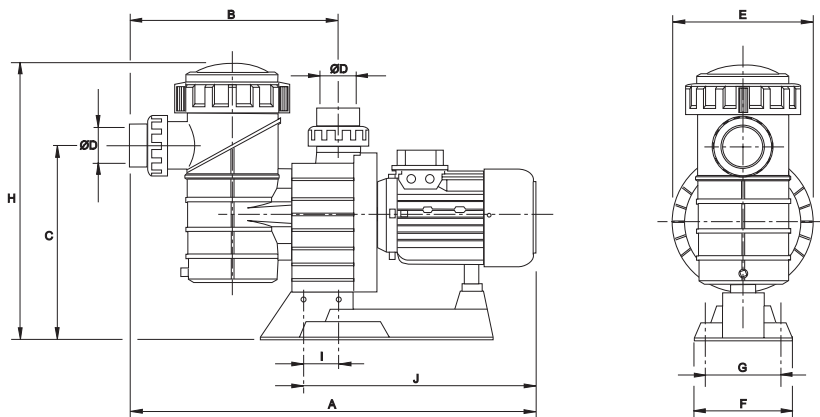

TECHNICAL FEATURES

Code	Power	Connection	Voltage	mca					
				8	10	12	14	16	19.5
				m ³ /h					
08003	3.5 HP	3" threaded joint	230/400 V III	56	50	42	34	23	0
08004	4.5 HP		230/400 V III	74	66	57	46	30	0
08005	5.5 HP		230/400 V III	88	78	67	53	34	0

Model	Type	Voltage	A mm	B mm	C mm	Ø D mm	E mm	F mm	G mm	H mm	I mm	J mm
08003	3,5	230/400	815	430	385	90	287	200	140	530	65	468
08004	4,5	230/400	815	430	385	90	287	200	140	530	65	468
08005	5,5	230/400	847	430	385	90	287	200	140	530	65	500

PERFORMANCE CURVES

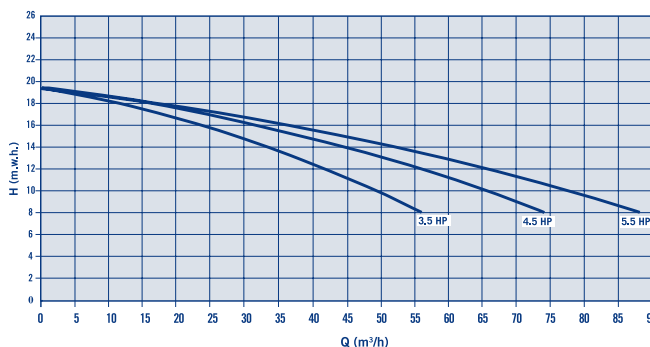

Aral C-3000



Optional:
60 Hz pumps (code
XXXX-0810).

230 V valid for voltages
between 220 & 240 V

400 V valid for voltages
between 380 & 420 V

690 V valid for voltages
between 660 & 720 V

**More technical
specifications on the
next page**

DESCRIPTION

Made in cast iron. Mechanical seal in stainless steel. IP-54 motor protection. AISI-316 stainless steel shaft. With stainless steel AISI-304 strainer basket and prefilter. 3000 rpm.

Connections PN 16 according to DIN 2501. Also available with bronze impeller.

	Code	Standard Pack	Standard weight in kg	Standard volume in m ³
Aral C-3000 3 HP	01193	1	71	0.162
Aral C-3000 4 HP	01195	1	74	0.162
Aral C-3000 5.5 HP DN 80-3"	01197	1	80	0.162
Aral C-3000 5.5 HP DN 100-4"	01199	1	89	0.197
Aral C-3000 7.5 HP	01201	1	113	0.197
Aral C-3000 10 HP	01203	1	115	0.197
Aral C-3000 12.5 HP	01205	1	115	0.197
Aral C-3000 15 HP	01207	1	121	0.197

TECHNICAL FEATURES

Code	Power	Connection	Voltage	mca											
				8	10	12	14	16	18	19	20	21	22		
				m ³ /h											
01193	2.20 kW (3 HP)	DN 90-3"	230/400 V III	59	54	46	40	30	0						
01195	2.95 kW (4 HP)	DN 80-3"	400/690 V III	67	61	55	48	40	n/a	0					
01197	4.00 kW (5.5 HP)	DN 80-3"	400/690 V III	78	72	66	60	52	n/a	n/a	0				
01199	4.00 kW (5.5 HP)	DN 100-4"	400/690 V III	100	89	70	60	48	n/a	n/a	0				
01201	5.50 kW (7.5 HP)	DN 100-4"	400/690 V III	126	115	100	80	60	n/a	0					
01203	7.50 kW (10 HP)	DN 100-4"	400/690 V III	145	140	123	107	86	n/a	n/a	0				
01205	9.20 kW (12.5 HP)	DN 125-5"	400/690 V III	165	158	149	135	115	n/a	n/a	n/a	0			
01207	11,04 kW (15 HP)	DN 125-5"	400/690 V III	195	190	175	160	140	n/a	n/a	n/a	n/a	0		

Aral C-3000

TECHNICAL FEATURES

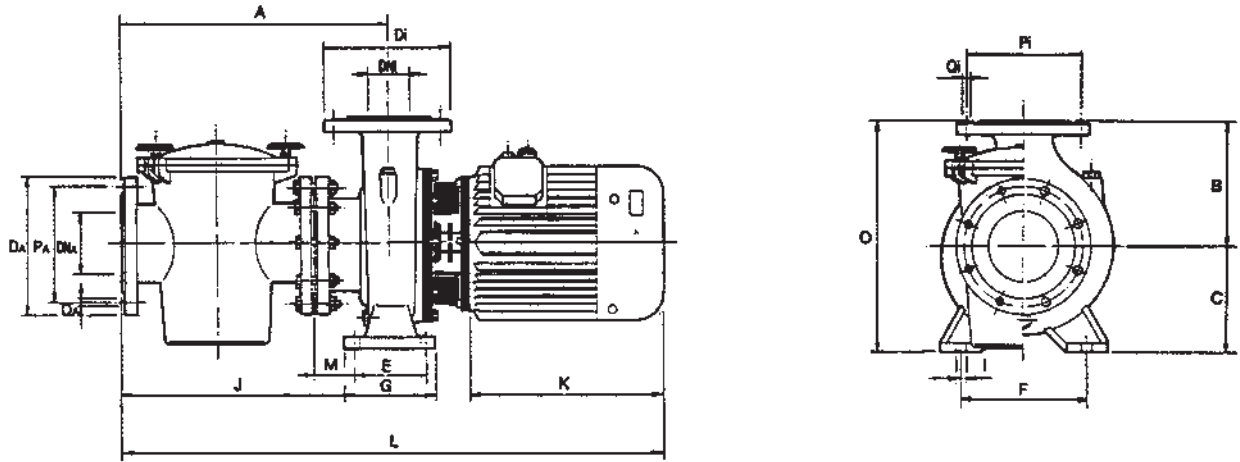

Code	Voltage V	Intensity		Power		Suction connection					Return connection				
		III 230 V	III 400 V	kW	HP	DA (mm)	DNA	PA (mm)	QA		Di (mm)	DNi	Pi (mm)	Qi	
								N°	Ø (mm)				N°	Ø (mm)	
01193	230/400	9	5.2	2.20	3	200	80-3"	160	8	18	200	80-3"	160	8	18
01195	400/690	-	7	2.95	4	200	80-3"	160	8	18	200	80-3"	160	8	18
01197	400/690	-	9.1	4	5.5	200	80-3"	160	8	18	200	80-3"	160	8	18
01199	400/690	-	9.1	4	5.5	220	100-4"	180	8	18	220	100-4"	180	8	18
01201	400/690	-	11	5.5	7.5	220	100-4"	180	8	18	220	100-4"	180	8	18
01203	400/690	-	15	7.5	10	220	100-4"	180	8	18	220	100-4"	180	8	18
01205	400/690	-	22	9.2	12.5	250	125-5"	210	8	18	220	100-4"	210	8	18
01207	400/690	-	22.5	11.04	15	250	125-5"	210	8	18	250	125-5"	210	8	18

Code	Power		Dimensions (mm)											
	kW	HP	A	B	C	E	F	G	I	J	K	L	M	O
01193	2.20	3	485	180	160	70	212	100	14	435	245	888	65	340
01195	2.95	4	485	180	160	70	212	100	14	435	245	888	65	340
01197	4	5,5	485	180	160	70	212	100	14	435	273	920	65	340
01199	4	5,5	487	205	160	95	187	125	14	425	273	940	55	365
01201	5.5	7,5	487	205	160	95	187	125	14	425	315	976	55	365
01203	7.5	10	487	205	160	95	187	125	14	425	315	976	55	365
01205	9.2	12,5	487	205	160	95	187	125	14	425	355	1016	55	365
01207	11.04	15	517	233	181	95	187	125	14	455	355	1029	70	365

CENTRIFUGAL PUMPS

Aral C-1500



Optional:
60 Hz pumps (code
XXXX-0810).

400 V valid for voltages
between 380 & 420 V

690 V valid for voltages
between 660 & 720 V

**More technical
specifications on the
next page**

DESCRIPTION

Made in cast iron. Mechanical seal in stainless steel. IP-54 motor protection. Stainless steel AISI- 316 shaft. With stainless steel (AISI-304 11 L - AISI-316 37 L) strainer basket. Connections PN 16 according to DIN 2501. 1,450 rpm. Connections PN 16 according to DIN 2501.

Connections PN 16 according to DIN 2501.

Also available with bronze impeller.

	Code	Standard Pack	Standard weight in kg	Standard volume in m ³
Aral C-1500 4 HP	01210	1	115.0	0.195
Aral C-1500 5.5 HP DN 80-3"	01212	1	142.0	0.195
Aral C-1500 7.5 HP	01216	1	170.0	0.407
Aral C-1500 10 HP	01218	1	179.0	0.407
Aral C-1500 12.5 HP	01220	1	215.0	0.407
Aral C-1500 15 HP	01222	1	245.0	0.407
Aral C-1500 20 HP	01224	1	255.0	0.407
Aral C-1500 25 HP	01226	1	255.0	0.407

TECHNICAL FEATURES

Code	Power	Suction Connection	Connection Return	Voltage	mca					
					10	12	14	16	18	20
					m ³ /h					
01210	3.00 kW (4 HP)	DN 80-3"	DN 65-2½"	400/690 V III	68	60	45	0	0	0
01212	4.00 kW (5.5 HP)	DN 80-3"	DN 65-2½"	400/690 V III	88	80	70	58	0	0
01216	5.50 kW (7.5 HP)	DN 100-4"	DN 80-3"	400/690 V III	115	101	87	70	0	0
01218	7.50 kW (10 HP)	DN 100-4"	DN 80-3"	400/690 V III	150	140	125	115	NA	0
01220	9.20 kW (12.5 HP)	DN 125-5"	DN 100-4"	400/690 V III	192	175	155	130	NA	0
01222	11 kW (15 HP)	DN 125-5"	DN 100-4"	400/690 V III	200	185	165	145	125	95
01224	15,00 kW (20 HP)	DN 150-6"	DN 125-5"	400/690 V III	240	210	180	145	105	0
01226	18.40 kW (25 HP)	DN 150-6"	DN 125-5"	400/690 V III	275	258	234	202	169	120

Aral C-1500

TECHNICAL FEATURES

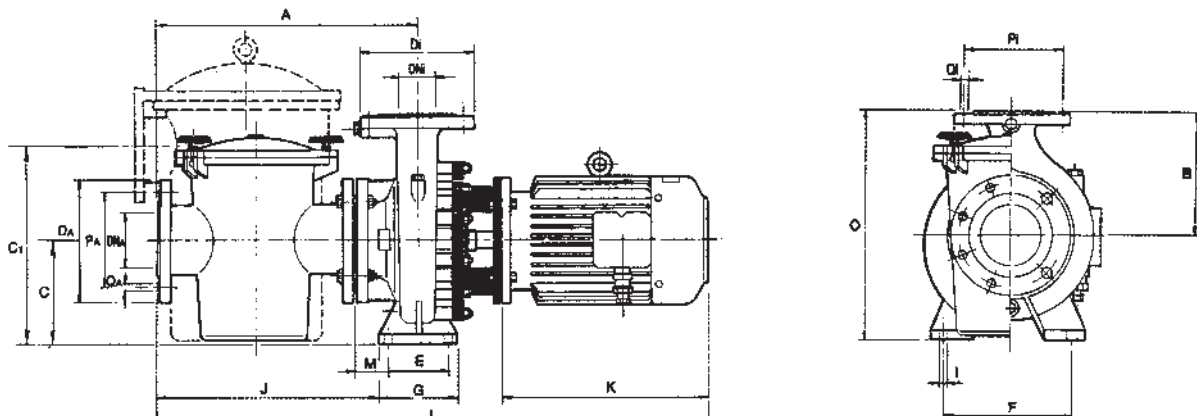

Code	Voltage V	Intensity		Power		Suction connection				Return connection					
		III 230 V	III 400 V	kW	HP	DA (mm)	DNA	PA (mm)	QA		Di (mm)	DNi	Pi (mm)	Qi	
									N°	Ø (mm)				N°	Ø (mm)
01210	400/690	-	7	3	4	200	80-3"	160	8	18	185	65-2½"	145	4	18
01212	400/690	-	9.7	4	5.5	200	80-3"	160	8	18	185	65-2½"	145	4	18
01216	400/690	-	12.3	5.5	7.5	220	100-4"	180	8	18	200	80-3"	160	8	18
01218	400/690	-	16.4	7.5	10	220	100-4"	180	8	18	200	80-3"	160	8	18
01220	400/690	-	19	9.20	12.5	250	125-5"	210	8	18	220	100-4"	180	8	18
01222	400/690	-	24	11	15	250	125-5"	210	8	18	220	100-4"	180	8	18
01224	400/690	-	32	15	20	285	150-6"	240	8	22	250	125-5"	210	8	18
*01226	400/690	-	36	18.40	25	285	150-6"	240	8	22	250	125-5"	210	8	18

Code	Power		Dimensions (mm)												
	kW	HP	A	B	C	Cl	E	F	G	I	J	K	L	M	O
01210	2.95	4	482	225	180	-	95	250	125	14	419	310	880	50	405
01212	4	5.5	484	253	196	-	120	280	162	18	403	333	967	34	449
01216	5.5	7.5	514	282	193	-	120	315	162	18	433	410	1072	69	486
01218	7.5	10	514	282	193	-	120	315	162	18	433	450	1112	69	486
01220	9.20	12.5	522	280	224	-	120	315	162	18	441	450	1128	77	504
01222	11	15	522	280	224	-	120	315	162	18	441	490	1188	77	504
01224	*15	20	747	356	255	507	120	315	158	18	668	520	1438	87	611
01226	*18.40	25	747	356	255	507	120	315	158	18	668	555	1473	87	611

*With strainer 37 l

STRAINERS

Strainer in polypropylene and fibreglass



DESCRIPTION

Flanges drilled according to DIN-2501 Standard. Supplied with 3 piece coupling at the inlet. 8 litre capacity.
Inlet size: Ø 90 mm and outlet Ø 110 mm.

	Code	Standard Pack	Standard weight in kg	Standard volume in m ³
Strainer	09879	1	8.4	0.098

Strainer in polyester and fibreglass 33 l capacity



DESCRIPTION

Flanges drilled according to DIN-2501 Standard. Hoop type clamp. Drain plug. Maximum working pressure: 1.5 bar.

	Code	Standard Pack	Standard weight in kg	Standard volume in m ³
33 l Capacity				
Connections Ø 90 mm, 37 m ³ /h	04656	1	27	0.180
Connections Ø 110 mm, 55 m ³ /h	04657	1	27	0.180
Connections Ø 125 mm, 72 m ³ /h	04658	1	27	0.180
Connections Ø 140 mm, 90 m ³ /h	04659	1	27	0.180

Strainer in polyester and fibreglass 60 l capacity



DESCRIPTION

Flanges drilled according to DIN-2501 Standard. Hoop type clamp. Drain plug. Maximum working pressure: 1.5 bar.

	Code	Standard Pack	Standard weight in kg	Standard volume in m ³
60 l Capacity				
Connections Ø 160 mm, 118 m ³ /h	10886	1	39	0,357
Connections Ø 200 mm, 184 m ³ /h	10887	1	39	0,357
Connections Ø 225 mm, 233 m ³ /h	10888	1	39	0,357

Strainer

in polyester and fibreglass with sight glass lid 33 l capacity



DESCRIPTION

Flanges drilled according to DIN-2501 Standard. Hoop type clamp. Drain plug. Maximum working pressure: 1.5 bar.

	Code	Standard Pack	Standard weight in kg	Standard volume in m ³
33 l Capacity				
Connections Ø 90 mm, 37 m ³ /h	15644	1	27	0.180
Connections Ø 110 mm, 55 m ³ /h	15645	1	27	0.180
Connections Ø 125 mm, 72 m ³ /h	15646	1	27	0.180
Connections Ø 140 mm, 90 m ³ /h	15647	1	27	0.180
Strainer 3", 37 m ³ /h	15648	1	27	0.180
Strainer 4", 55 m ³ /h	15649	1	27	0.180

TECHNICAL FEATURES

Code	15644	15645	15646	15647	15648	15649
H	635	635	635	635	635	635
D	475	475	475	475	475	475
M	353	353	353	353	353	353
Ø	90	110	125	140	3"	4"
E	500	516	532	546	500	516

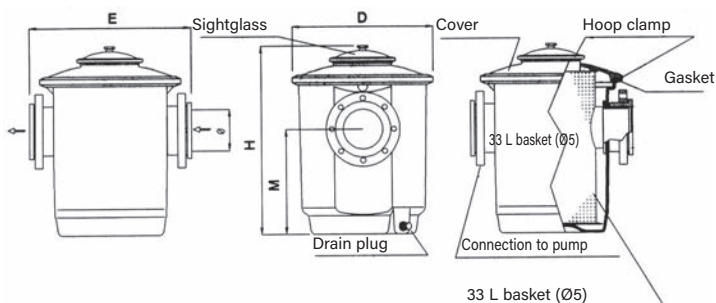

Strainer

in polyester and fibreglass with sight glass lid 60 l capacity



DESCRIPTION

Flanges drilled as per DIN-2501 Standard. Hoop type clamp. Drain plug. Maximum working pressure: 1,5 bar.

	Code	Standard Pack	Standard weight in kg	Standard volume in m ³
60 l Capacity				
Connections Ø 160 mm, 118 m ³ /h	15650	1	39	0.357
Connections Ø 200 mm, 174 m ³ /h	15651	1	39	0.357
Connections Ø 225 mm, 233 m ³ /h	15652	1	39	0.357
Strainer 6", 118 m ³ /h	15653	1	39	0.357
Strainer 8", 233 m ³ /h	15654	1	39	0.357

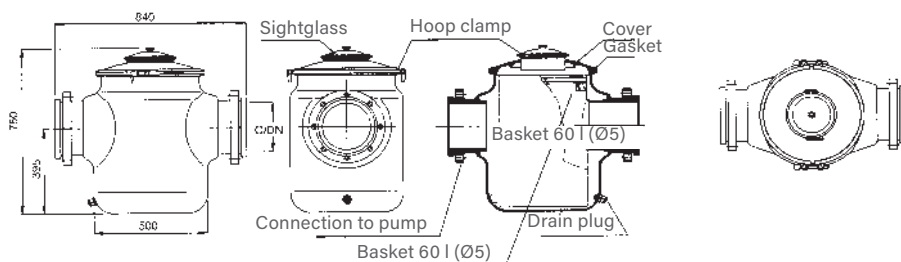

STRAINERS

Kivu strainers



DESCRIPTION

Flanges drilled to standard DIN-2501. Quick closing lid. Polypropylene basket. Drain plug. Maximum working pressure 1.5 bar.

	Code	Standard Pack	Standard weight in kg	Standard volume in m ³
25 l Capacity 6" Connections DN 150	56733	1	9.9	0.08

Astramax strainers



DESCRIPTION

Strainer for Astramax pump. Body in ABS and fibreglass. With transparent lid and anti-corrosive strainer basket. Suction 2¼" male thread. Connection to pump 2¾" female thread.

	Code	Standard Pack	Standard weight in kg	Standard volume in m ³
Strainer Astramax pump	16104	1	1.5	0.017

Aral strainers



Aral 11 l

DESCRIPTION

Housing and cover in cast iron. AISI-304 Stainless Steel Strainer basket. Flange connection are manufactured in accordance with DIN-2501 Standard. Maximum working pressure 2.5 bar.

	Code	Standard Pack	Standard weight in kg	Standard volume in m ³
11 l Capacity				
Flanges DN 65 (2½") DN 65 (2½")	20026	1	35	0.051
Flanges DN 80 (3") DN 80 (3")	20028	1	35	0.051
Flanges DN 100 (4") DN 100 (4")	20029	1	35	0.051
Flanges DN 125 (5") DN 125 (5")	20030	1	35	0.051
Flanges DN 80 (3") DN 65 (2½")	20031	1	35	0.051
Flanges DN100 (4") DN 80 (3")	20032	1	35	0.051
Flanges DN 125 (5") DN 100 (4")	20033	1	35	0.051
37 l Capacity				
Flanges DN 150 (6") DN 150 (6")	01268	1	129	0.319



Aral 37 l



Strainers in stainless steel



DESCRIPTION

With removable basket. Housing in AISI-304 and strainer basket in AISI-316. Models come in varying diameters to suit pump suction (impeller protection). Rough straining for different installations.



	Code	Standard Pack	Standard weight in kg	Standard volume in m ³
S.S. strainer DN 100 with PVC flange	21461	1	17.6	0.06
S.S. strainer DN 100 TF with PVC flange	21462	1	21.6	0.09
S.S. strainer DN 125 with PVC flange	21463	1	19.0	0.06
S.S. strainer DN 125 TF with PVC flange	21464	1	23.0	0.09
S.S. strainer DN 150 with PVC flange	21465	1	24.8	0.08
S.S. strainer DN 150 TF with PVC flange	21466	1	31.0	0.13
S.S. strainer DN 200 with PVC flange	21467	1	25.4	0.08
S.S. strainer DN 200 TF with PVC flange	21468	1	31.6	0.13

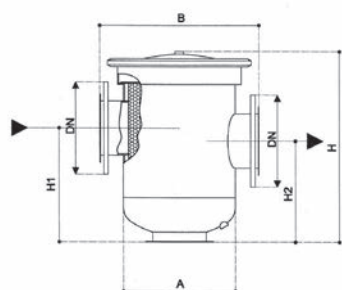

STANDARD model

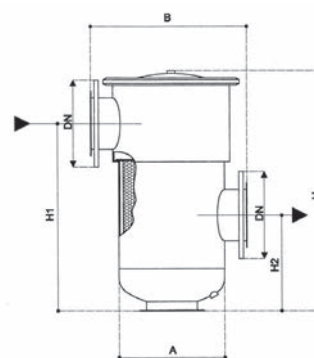

TF model

TECHNICAL FEATURES

Code	Diameter		Pressure (bar)	External volume					Material	Interior basket			Total weight
	Input connection	Relief		Dimensions (mm)						Dimensions (mm)			
				A	B	H	H1	H2		Ø	H	Perforation	
21461	DN 100	½"	3	292	410	520	294	254	AISI 316	270	350	6 mm	17.6
21462	DN 100	½"	3	292	425	735	593	308	AISI 316	270	415	6 mm	21.6
21463	DN 125	½"	3	292	410	520	294	254	AISI 316	270	350	6 mm	19.0
21464	DN 125	½"	3	292	425	735	593	308	AISI 316	270	415	6 mm	23.0
21465	DN 150	½"	3	350	450	520	294	254	AISI 316	320	350	6 mm	24.8
21466	DN 150	½"	3	350	470	775	595	295	AISI 316	320	415	6 mm	31.0
21467	DN 200	½"	3	350	450	520	294	254	AISI 316	320	350	6 mm	25.4
21468	DN 200	½"	3	350	470	775	595	295	AISI 316	320	415	6 mm	31.6

Check valves



DESCRIPTION

Nominal pressure 10 kg/cm². Mounted between flanges. Available in PN 16 and PN 25 under special order.

	Code	Standard Pack	Standard weight in kg	Standard volume in m ³
Outlets Ø 50 mm	20239	1	-	-
Outlets Ø 65 mm	20240	1	-	-
Outlets Ø 80 mm	20241	1	-	-
Outlets Ø 100 mm	20242	1	-	-
Outlets Ø 125 mm	20243	1	-	-
Outlets Ø 150 mm	20244	1	-	-
Outlets Ø 200 mm	20245	1	-	-
Outlets Ø 250 mm	20246	1	-	-

Vibration absorbent brushing



DESCRIPTION

Flanges in galvanized steel. Elastic material: Polychloroprene. Maximum temperature: 95° C. Nominal pressure: 10 kg/cm² (PN/10).

	Code	Standard Pack	Standard weight in kg	Standard volume in m ³
Outlets Ø 50 mm	20231	1	-	-
Outlets Ø 65 mm	20232	1	-	-
Outlets Ø 80 mm	20233	1	-	-
Outlets Ø 100 mm	20234	1	-	-
Outlets Ø 125 mm	20235	1	-	-
Outlets Ø 150 mm	20236	1	-	-
Outlets Ø 200 mm	20237	1	-	-
Outlets Ø 250 mm	20238	1	-	-

Air blowers



DESCRIPTION

Air pump designed for spas, baths, hydromassage installations and similar which produces a constant stream of air bubbles at medium and high air volume levels. It can also be used to stir up the filter bed, for example in back wash cycles where a low intensity air current is required.

The filter casing and impeller are made from an injected aluminium alloy whilst the motor spindle is manufactured from stainless steel, with the impeller dynamically balanced and directly adapted to the spindle. The motors, single phase or 3 phase for continuous use, are made from steel in compliance with CEI 2/3 1988 regulations, and feature IP54 external protection and class-F insulation. The standard voltages are 100-120/200-240V for the monophase range and 200-240/380-440V for the triphase models, at 50/60Hz. The pumps can be mounted horizontally or vertically. Moreover, since there is no contact between the mobile parts and the pump static discharges, neither lubrication nor maintenance is necessary and it does not cause wear on the parts.

The turbines have a maximum working temperature of 40°C. Do not use in conjunction with aggressive, inflammable or explosive gases.

TECHNICAL FEATURES

Model	Code	Frequency (Hz)	Voltage (V)	Phase	Flow rate (m ³ /h)	Max. Pressure (mbar)	Standard Weight kg	Standard Volume m ³
Blower 0.4 kW	33970-2450	50	Δ 200-240 Y 345-415	3	80	130	10	0.045
Blower 0.5 kW		60	Δ 220-275 Y 380-480	3	98	170		
Blower 0.85 kW	35388-2450	50	200-240	1	145	160	17	0.059
Blower 0.95 kW		60	200-240	1	175	160		
Blower 0.85 kW	35387-2450	50	Δ 200-240 Y 345-415	3	145	160	16	0.045
Blower 0.95 kW		60	Δ 220-275 Y 380-480	3	175	160		
Blower 1.3 kW	31090-2450	50	200-240	1	210	170	23	0.059
Blower 1.5 kW		60	200-240	1	255	140		
Blower 1.3 kW	31091-2450	50	Δ 200-240 Y 345-415	3	210	170	22	0.059
Blower 1.5 kW		60	Δ 220-275 Y 380-480	3	255	140		
Blower 1.5 kW	33971-2450	50	200-240	1	210	220	24	0.064
Blower 1.75 kW		60	200-240	1	255	220		
Blower 1.6 kW	31092-2450	50	Δ 200-240 Y 345-415	3	210	220	23	0.064
Blower 2.1 kW		60	Δ 220-275 Y 380-480	3	255	220		
Blower 1.6 kW 2V	35389-2450	50	Δ 200-240 Y 345-415	3	150	300	25	0.087
Blower 2.06 kW 2V		60	Δ 220-275 Y 380-480	3	180	310		
Blower 2.2 kW	31093-2450	50	Δ 200-240 Y 345-415	3	318	230	30	0.097
Blower 2.55 kW		60	Δ 220-275 Y 380-480	3	376	220		
Blower 3.0 kW 2V	31094-2450	50	Δ 200-240 Y 345-415	3	230	410	40	0.126
Blower 3.45 kW 2V		60	Δ 220-275 Y 380-480	3	275	400		
Blower 3.0 kW	31095-2450	50	Δ 200-240 Y 345-415	3	318	280	36	0.097
Blower 3.45 kW		60	Δ 220-275 Y 380-480	3	376	280		
Blower 4.3 kW 2V	31096-2450	50	Δ 345-415 Y 600-720	3	520	600	54	0.217
Blower 4.8 kW 2V		60	Δ 380-480 Y 660-720	3	385	320		
Blower 5.5 kW	31097-2450	50	Δ 345-415 Y 600-720	3	530	320	63	0.16
Blower 6.3 kW		60	Δ 380-480 Y 660-720	3	620	340		
Blower 5.5 kW 2V	33972-2450	50	Δ 345-415 Y 600-720	3	320	515	66	0.201
Blower 6.3 kW 2V		60	Δ 380-480 Y 660-720	3	385	530		
Blower 7.5 kW	31098-2450	50	Δ 345-415 Y 600-720	3	530	400	66	0.16
Blower 8.6 kW		60	Δ 380-480 Y 660-720	3	620	400		
Blower 11 kW 2V	33973-2450	50	Δ 345-415 Y 600-720	3	520	600	104	0.353
Blower 12.6 kW 2V		60	Δ 380-480 Y 660-720	3	620	600		
Blower 12.5 kW	33974-2450	50	Δ 345-415 Y 600-720	3	1050	270	116	0.353
Blower 14.5 kW		60	Δ 380-480 Y 660-720	3	1250	260		





COMMERCIAL POOLS

WATER TREATMENT EQUIPMENT



710 FREEPOOL²

- 711 Freepool²
- 711 AP PR-200 control unit compatible with Freepool²

712 SALT ELECTROLYSIS AND PH/CL CONTROL

- 712 Easy Salt
- 713 Easy Salt Next
- 714 Pro-Chlore Salt
- 715 Nature Salt

716 NEOLYSIS FOR COMMERCIAL POOLS

- 716 Neolysis S (5-6 g/L) + UV
- 717 Neolysis LS (1.5-2 g/L) + UV
- 717 LS/S Neolysis lamps
- 717 LS/S Neolysis electrodes

718 AUTOMATIC UV DISINFECTION FOR COMMERCIAL POOLS

- 718 Heliox UV MP
- 720 Heliox UV MP lamps
- 720 Heliox UV LP
- 720 Heliox UV LP S.S. (Stainless Steel)
- 721 Heliox UV LP PE (PolyEthylene)
- 721 Heliox UV LP lamps

722 DOSING PUMPS FOR COMMERCIAL POOLS

- 722 Exactus dosing pumps
- 725 Optima dosing pumps
- 728 Peristaltic dosing pumps
- 728 Polyethylene cylindrical tanks
- 729 Manual stirrer

729 CONTINUOUS FLOCCULATION SYSTEM

- 729 Floc System

729 WATER METERS

- 729 Woltman type turbine meters

730 AUTOMATIC REGULATION AND CONTROL EQUIPMENT

- 730 AP PR-200
- 730 Control Connect
- 731 Amperometric Chlorine Sensors
- 731 pH / ORP Sensors
- 731 Calibration Solutions
- 731 Pool Patrol
- 732 Guardian Pool
- 733 Controller

freepool²

Salt chlorinator + UV + CO₂

Freepool² disinfects the water thanks to the salt chlorinator and the UV and corrects pH levels by injecting CO₂ through the reactor

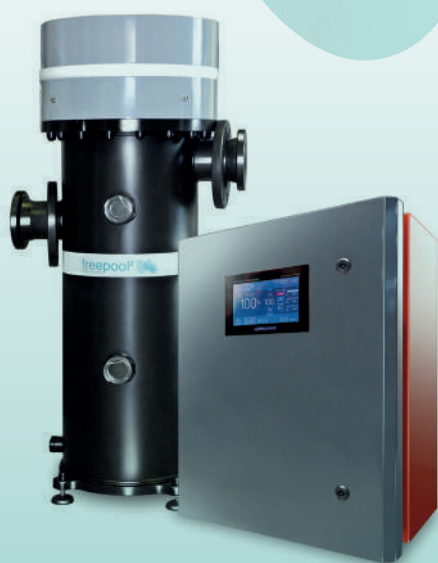

75% reduction



in the concentration of **oxidants** in the atmosphere, improving the quality of the atmosphere and reducing the smell of chlorine.

20% reduction



of **combined chloramines** in the water, reducing skin and eye irritation and respiratory complications.

100% reduction



in the addition of diluted **acids and chlorinated products**, completely avoids the need to add chlorinated products and acids.

66% reduction



in the consumption of new supplies of **water**, with savings in water and energy wherever it is installed.

The benefits of Freepool have been backed up by two studies conducted by Universitat Autònoma de Barcelona and Hospital Universitari Clínic de Barcelona.



FREEPOOL²
INTRODUCTION

Pools without chemical products that deliver unbeatable water and air quality

- + Public pool water treatment and disinfection system.
- + Freepool² keeps the quality of water to the highest standards without the need to add chemical products.
- + Freepool² is a unique product that comes with three water treatment technologies that optimize disinfection and pH levels: a low-salinity salt chlorinator for disinfecting the water, medium-pressure UV for reducing combined chloramines and a CO₂ injection system for adjusting the pH.

The main advantages of Freepool² are:

- + Water quality. Studies carried out by Universidad Autónoma de Barcelona and Hospital Clínic de Barcelona revealed that swimmers' perception of a "perfectly clean" atmosphere increased significantly.
- + Safety. There is no need to store, handle or measure out chemicals and it is therefore a safer system.

Technical features:

- + Chlorine output of 180 g/h
- + Three 90 W UV lamps
- + CO₂ injector and pH control kit for dosing and absorption



Freepool²



	Code	Standard Pack	Standard weight in kg	Standard volume in m ³
Freepool ² 180g Cl/h	70990	1	-	-

AP PR-200 control unit

compatible with Freepool²



	Code	Standard Pack	Standard weight in kg	Standard volume in m ³
Recommended unit:				
AP PR-207 pH/Cl ₂ PPM*	60361	1	-	-
AP PR-207 pH/Cl ₂ PPM + integrated TRI KIT*	60361-KIT TRI	1	-	-
ECCIS Electrolyte / free chlorine sensor gel (seawater)	64658	1	-	-

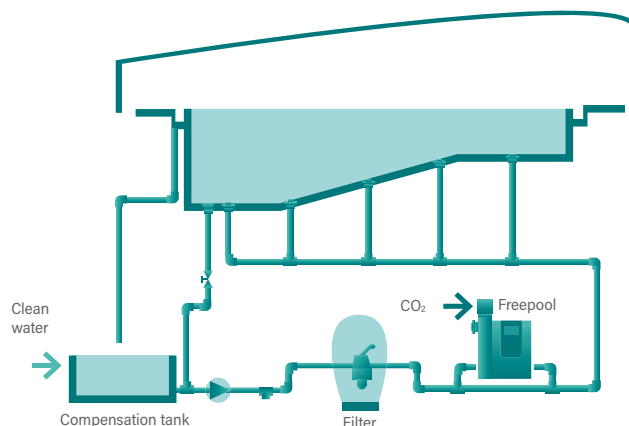

- Water chlorinators for commercial pools are becoming popular because they are efficient, practical, safe and well priced.
- Our wide range of industrial electrolysis systems covers self-cleaning equipment of up to 600 grams/hour of Chlorine, which makes it possible to use saline electrolysis to treat the water at any public use facility.

Main advantages:

- **Safety:** There is no need to store, handle or dose any chemical products and therefore it is a much safer system. The raw material stored is common salt.
- **Savings:** The introduction of saline electrolysis systems can bring net savings in operating costs of around 50-60%, with respect to traditional systems.
- Peristaltic pump not included.

TECHNICAL FEATURES

	Easy Salt	Easy Salt Next	Pro-Chlore Salt	Nature Salt
Self-cleaning electrodes	10,000 - 12,000 h	10,000 - 12,000 h	12,000 - 15,000 h	12,000 - 15,000 h
Salinity range	5-12 g/l (recommended 5-6 g/l)	5-12 g/l (recommended 5-6 g/l)	5-12 g/l (recommended 5-6 g/l)	1.5-3 g/l (recommended: 2-2.5 g/l) (*)
Production (g/h)	50 - 180	75 - 190	50 - 600	50 - 300

(*) Operating range 1.5-5 g/l depending on the temperature (28-35 °C) and nominal output (80-100%)

Easy Salt

DESCRIPTION

SELF-CLEANING salt electrolysis system for residential and public pool applications of up to 180 g chlorine/hour. Easy Salt is a compact and cost-competitive piece of equipment. To control more than one unit for the same pool you will need an AP PR-200 external control or Smart Control and the TRI multiple control kit (code 70338).

	Code	Standard Pack	Standard weight in kg	Standard volume in m ³
Easy Salt 50	66151	1	30	0.29
Easy Salt 70	53799	1	70	0.29
Easy Salt 90	53801	1	80	0.29
Easy Salt 180	53803	1	90	0.29
External control option (AP PR 60359-60361-60362, Smart Control 54523-4-5)				
Easy Salt 50 + pH/ORP (EXT-1)	66153	1	30	0.29
Easy Salt 70 + pH/ORP (EXT-1)	53800	1	70	0.29
Easy Salt 90 + pH/ORP (EXT-1)	53802	1	80	0.29
Easy Salt 180 + pH/ORP (EXT-1)	53804	1	90	0.29
Optional sensor holder for EXT-1 (EXT-1+66448 = EXT-1D)	66448	1	-	-
Optional: Connection kit compatible with Fluidra Connect	60363	1	0.39	0.002

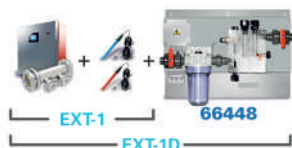

Fluidra Connect compatible



Easy Salt Next



DESCRIPTION

Easy Salt Next is the next generation of salt electrolysis system for residential and public pool applications of up to 190 g chlorine/hour. Easy Salt Next has a compact and cost-competitive equipment design. Made with high-pressure (polypropylene) cells equipped with Premium+ grade electrodes (up to 12.000 hours). The device includes a display LED screen to improve the user interface. Expandable functions with AP PR-200 controllers series.

	Code	Standard Pack	Standard weight in kg	Standard volume in m ³
Easy Salt Next 75	72663	1	25	0.29
Easy Salt Next 100	72665	1	25	0.29
Easy Salt Next 150	72667	1	35	0.29
Easy Salt Next 190	72669	1	35	0.29
Easy Salt Next 75 pH/ORP	72664	1	25	0.29
Easy Salt Next 100 pH/ORP	72666	1	25	0.29
Easy Salt Next 150 pH/ORP	72668	1	35	0.29
Easy Salt Next 190 pH/ORP	72670	1	35	0.29

Valid for Easy Salt/Easy Salt Next and Pro-Chlore Salt and Nature Salt:

TECHNICAL FEATURES

	pH	ORP	FREE CHLORINE*
Components supplied	H-035 sensor pH calibration solution (7,0/4,0)	RX-02 sensor ORP calibration solution (470 mV)	CL0102 sensor ID-CAL calibration card
	Two PE ½" sensor holder connectors (standard in all models); sensor holder panel with inductive flow rate detector; flow rate and pre-filter adjustment (standard in ppm models)		
Size	600 x 240 x 120 mm (panel)		
pH control output	230 V / 50-60 Hz / 0,5 A max, ON/OFF		
Scale	0.0 - 9.9	0 - 999 mV	0.0 - 5.0 ppm
Control range	7.0 - 7.8	650 - 850 mV	0.0 - 5.0 ppm
Accuracy	0.1 pH	1 mV	0.1 ppm
Calibration	(pH) Automatic; two modes Fast: one-point calibration Standard: Two-point calibration	Automatic: one-point calibration	FREE CHLORINE: automatic (one-point using external DPD calibrator - not supplied)

*Not available for Easy Salt

Pro-Chlore Salt

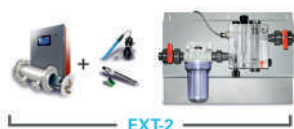
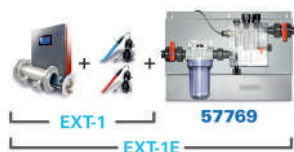

AM



DESCRIPTION

Our Pro-Chlore Salt range includes EX electrodes that provide the highest level of durability in self-cleaning systems. The Pro-Chlore Salt range with its integrated EXTENSION options (EXT-1, EXT-1E, EXT-2) or external control options (AP PR200, Smart Control) includes a control and regulation system for ORP values (Redox) or ppm, as well as pH, allowing improved management of the equipment and an excellent water quality at all times. The Pro-Chlore range can be manufactured, on request, for seawater (Pro Chlore Salt AM Series). To control more than one unit for the same pool you will need an AP PR-200 external control or Smart Control and the TRI multiple control kit (code 70338).

	Code	Standard Pack	Standard weight in kg	Standard volume in m ³
Pro-Chlore Salt A-50EX	35252	1	55	0.17
Pro-Chlore Salt A-80EX	35253	1	65	0.19
Pro-Chlore Salt A-120EX	35254	1	100	0.36
Pro-Chlore Salt A-180EX	35255	1	120	0.36
Pro-Chlore Salt A-300EX	35256	1	140	0.36
Pro-Chlore Salt A-600EX	35257	1	200	0.74
External control option (AP PR 60359-60361-60362, Smart Control 54523-4-5)				
Pro-Chlore Salt A-50EX + pH/ORP (EXT-1)	35258	1	55	0.17
Pro-Chlore Salt A-80EX + pH/ORP (EXT-1)	35259	1	65	0.19
Pro-Chlore Salt A-120EX + pH/ORP (EXT-1)	35260	1	100	0.36
Pro-Chlore Salt A-180EX + pH/ORP (EXT-1)	35261	1	120	0.36
Pro-Chlore Salt A-300EX + pH/ORP (EXT-1)	35262	1	140	0.36
Pro-Chlore Salt A-600EX + pH/ORP (EXT-1)	35263	1	200	0.74
Optional sensor holder for EXT-1 (EXT-1+57769=EXT-1E)	57769	1	-	-
Pro-Chlore Salt A-50EX + pH/PPM (EXT-2)	45836	1	60	0.17
Pro-Chlore Salt A-80EX + pH/PPM (EXT-2)	45837	1	70	0.19
Pro-Chlore Salt A-120EX + pH/PPM (EXT-2)	45838	1	105	0.36
Pro-Chlore Salt A-180EX + pH/PPM (EXT-2)	45839	1	125	0.36
Pro-Chlore Salt A-300EX + pH/PPM (EXT-2)	45840	1	145	0.36
Pro-Chlore Salt A-600EX + pH/PPM (EXT-2)	45841	1	205	0.74

Sensor holder included with EXT-2

Options for seawater (on request).
Example: 45836-AM.

Optional:

Connection kit compatible with Fluidra Connect

60363	1	0.39	0.002
-------	---	------	-------

TECHNICAL FEATURES

	A-50	A-80	A-120	A-180	A-300	A-600
Power supply (AC)	230 V / 50 - 60 Hz			380 V / 50 - 60 Hz		
Power rating (AC) 30C 5 g/l	1.6 A	2.9 A	4.6 A	2.6 A	4.3 A	8.2 A
Cable:	H017 V/K					
Input (AC)	3 x 1.0 mm ²	3 x 1.0 mm ²	3 x 2.5 mm ²	5 x 1.5 mm ²	5 x 4 mm ²	5 x 4.0 mm ²
Output (DC)	2 x 10 mm ²	2 x 25 mm ²	2 x 35 mm ²	2 x 70 mm ²	2 x 120 mm ²	3 x 240 mm ²
Pipe connection	Female thread 1½"	Flanges D63 mm		Flanges D90 mm		
Fuse	5 AT (6 x 32 mm)	7 AT (6 x 32 mm)	10 AT (6 x 32 mm)	QM K10A	QM K20A	QM K25A
Outlet	9 V / 25 A	10 V / 40 A	10 V / 60A	10 V / 90 A	10 V / 150 A	10 V / 300 A
Cooling	Natural			Fan		
Minimum flow rate	9 m ³ /h	14 m ³ /h	20 m ³ /h	30 m ³ /h	50 m ³ /h	90 m ³ /h
Number of plates per electrode	8	12	8	12	16	2 x 15

Nature Salt

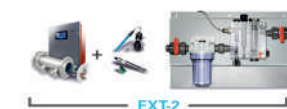
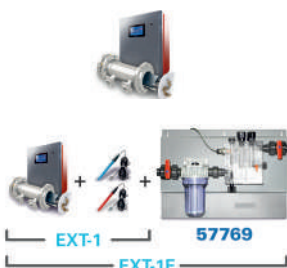

DESCRIPTION

Nature Salt equipment has a sustainable cycle through the removal of chloramines, 2 g salt/litre operation and chemical-free treatment. SELF-CLEANING industrial salt electrolysis system for public pool applications of up to 300 g chlorine/hour. High-pressure TWINCELL SYSTEM fitted with quality Nature Salt electrodes. To control more than one unit for the same pool you will need an AP PR-200 external control or Smart Control and the TRI multiple control kit (code 70338).

	Code	Standard Pack	Standard weight in kg	Standard volume in m ³
Nature Salt 50EX/LS	53810	1	80	0.17
Nature Salt 80EX/LS	53811	1	90	0.19
Nature Salt 120EX/LS	53812	1	130	0.36
Nature Salt 180EX/LS	53813	1	145	0.36
Nature Salt 300EX/LS	53814	1	170	0.36
External control option (AP PR 60359-60361-60362, Smart Control 54523-4-5)				
Nature Salt 50EX/LS + pH/ORP (EXT-1)	53815	1	80	0.17
Nature Salt 80EX/LS + pH/ORP (EXT-1)	53816	1	90	0.19
Nature Salt 120EX/LS + pH/ORP (EXT-1)	53817	1	130	0.36
Nature Salt 180EX/LS + pH/ORP (EXT-1)	53818	1	145	0.36
Nature Salt 300EX/LS + pH/ORP (EXT-1)	53819	1	170	0.36
Optional sensor holder for EXT-1 (EXT-1+57769=EXT-1E)	57769	1	-	-
Nature Salt 50EX/LS + pH/PPM (EXT-2)	53820	1	85	0.36
Nature Salt 80EX/LS + pH/PPM (EXT-2)	53821	1	95	0.36
Nature Salt 120EX/LS + pH/PPM (EXT-2)	53822	1	135	0.36
Nature Salt 180EX/LS + pH/PPM (EXT-2)	53823	1	150	0.74
Nature Salt 300EX/LS + pH/PPM (EXT-2)	53824	1	175	0.74
Sensor holder included with EXT-2				
Optional: Connection kit compatible with Fluidra Connect				
	60363	1	0.39	0.002

Self-cleaning electrodes



	Code	Standard Pack	Standard weight in kg	Standard volume in m ³
Pro-Chlore Salt Series				
A-50EX/EXT-1/EXT-2	60634	1	-	-
A-80EX/EXT-1/EXT-2	60636	1	-	-
A-120EX/EXT-1/EXT-2	60676	1	-	-
A-180EX/EXT-1/EXT-2	60677	1	-	-
A-300EX/EXT-1/EXT-2	60678	1	-	-
A-600EX/EXT-1/EXT-2	60679	1	-	-
Nature Salt Series				
A-50EX/LS/EXT-1/EXT-2	60680	1	-	-
A-80EX/LS/EXT-1/EXT-2	60681	1	-	-
A-120EX/LS/EXT-1/EXT-2	60682	1	-	-
A-180EX/LS/EXT-1/EXT-2	60683	1	-	-
A-300EX/LS/EXT-1/EXT-2	60684	1	-	-
Easy Salt Series				
EASY SALT 50/EXT-1	68104	1	-	-
EASY SALT 70/EXT-1	60685	1	-	-
EASY SALT 90/EXT-1	60686	1	-	-
EASY SALT 180/EXT-1	60687	1	-	-

- + Unbeatable water quality.
- + Dual disinfection based on UV and electrolysis.

- Neolysis, the most advanced water treatment by AstralPool: + Sustainability + Innovation + Disinfection + Healthy.
- Double lamp version (LP30 and LP30+).
- Two options: low salinity of 2-3 g/l (Neo LS) and standard salinity of 6 g/l (Neo S).
- The ultimate in chloramine reduction capacity (UV LP + Electrolysis).
- Self-cleaning electrodes that last 12,000-15,000 hours (NeoLS and Neo S).
- LP HO UV lamp (13,000 hours)
- Patented process.
- To control more than one unit for the same pool you will need an AP PR-200 external control or Smart Control and the TRI multiple control kit (code 70338).

WATER TREATMENT EQUIPMENT

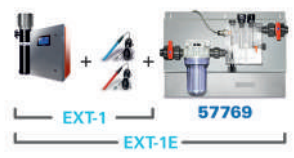
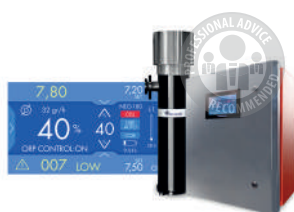

EXT-1 + 57769 = EXT-1E



Sensor holder included in EXT-2



Neolysis S (5-6 g/L) + UV



	Code	Standard Pack	Standard weight in kg	Standard volume in m ³
AP NEO/S 50 Gr/h + UV 75 W	66142	1	-	-
AP NEO/S 80 Gr/h + UV 90 W	66143	1	-	-
AP NEO/S 120 Gr/h + UV 2 x 90 W	66144	1	-	-
AP NEO/S 180 Gr/h + UV 3 x 90 W	68120	1	-	-
AP NEO/S 300 Gr/h + UV 4 x 90 W	68123	1	-	-
External control option (AP PR 60359-60361-60362, Smart Control 54523-4-5)				
With pH/ORP (EXT-1)				
AP NEO/S 50 Gr/h + UV 75 W	66145	1	-	-
AP NEO/S 80 Gr/h + UV 90 W	66146	1	-	-
AP NEO/S 120 Gr/h + UV 2 x 90 W	66147	1	-	-
AP NEO/S 180 Gr/h + UV 3 x 90 W	68121	1	-	-
AP NEO/S 300 Gr/h + UV 4 x 90 W	68124	1	-	-
Optional sensor holder for EXT-1	57769	1	-	-
With pH/PPM (EXT-2)				
AP NEO/S 50 Gr/h + UV 75 W	66148	1	-	-
AP NEO/S 80 Gr/h + UV 90 W	66149	1	-	-
AP NEO/S 120 Gr/h + UV 2 x 90 W	66150	1	-	-
AP NEO/S 180 Gr/h + UV 3 x 90 W	68122	1	-	-
AP NEO/S 300 Gr/h + UV 4 x 90 W	68125	1	-	-
Optional: Connection kit compatible with Fluidra Connect (without lamp control)	60363	1	0.39	0.002

TECHNICAL FEATURES

AP NEO Basic	AP NEO pH/ORP	AP NEO pH/PPM	Production Zero Salt Electrolysis + UV
66142	66145	66148	50 gr Cl ₂ /hr + 75 W UV
66143	66146	66149	80 gr Cl ₂ /hr + 90 W UV
66144	66147	66150	120 gr Cl ₂ /hr + 180 W UV
68120	68121	68122	180 gr Cl ₂ /hr + 270 W UV
68123	68124	68125	300 gr Cl ₂ /hr + 360 W UV

NEOLYSIS FOR COMMERCIAL POOLS

Neolysis LS (1.5-2 g/L) + UV



Sensor holder included in EXT-2



Fluidra Connect compatible

	Code	Standard Pack	Standard weight in kg	Standard volume in m ³
AP NEO 50 Gr/h + UV 75 W	57753	1	-	-
AP NEO 80 Gr/h + UV 90 W	57761	1	-	-
AP NEO 120 Gr/h + UV 2 x 90 W	57762	1	-	-
AP NEO 180 Gr/h + UV 3 x 90 W	68117	1	-	-
External control option (AP PR 60359-60361-60362, Smart Control 54523-4-5)				
With pH/ORP (EXT-1)				
AP NEO 50 Gr/h + UV 75 W	57763	1	-	-
AP NEO 80 Gr/h + UV 90 W	57764	1	-	-
AP NEO 120 Gr/h + UV 2 x 90 W	57765	1	-	-
AP NEO 180 Gr/h + UV 3 x 90 W	68118	1	-	-
Optional sensor holder for EXT-1	57769	1	-	-
With pH/PPM (EXT-2)				
AP NEO 50 Gr/h + UV 75 W	57766	1	-	-
AP NEO 80 Gr/h + UV 90 W	57767	1	-	-
AP NEO 120 Gr/h + UV 2 x 90 W	57768	1	-	-
AP NEO 180 Gr/h + UV 3 x 90 W	68119	1	-	-
Optional:				
Connection kit compatible with Fluidra Connect (without lamp control)	60363	1	0.39	0.002

TECHNICAL FEATURES

AP NEO Basic	AP NEO pH/ORP	AP NEO pH/PPM	Production Zero Salt Electrolysis + UV
57753	57763	57766	50 gr Cl ₂ /hr + 75 W UV
57761	57764	57767	80 gr Cl ₂ /hr + 90 W UV
57762	57765	57768	120 gr Cl ₂ /hr + 180 W UV
68117	68118	68119	180 gr Cl ₂ /hr + 270 W UV

LS/S Neolysis lamps



	Code	Standard Pack	Standard weight in kg	Standard volume in m ³
75-W UV LP-20 lamp (Codes 57753, 57763, 57766, 66142, 66145, 66148)	60608	1	0.10	-
90-W UV LP-25 lamp (Codes 57761, 57764, 57767, 68117, 68118, 68119, 66143, 66146, 66149, 68120, 68121, 68122, 68123, 68124, 68125)	60609	1	0.10	-
Lamp replacement kit UV LP 2x90 W (Codes 57762, 57765, 57768, 66144, 66147, 66150)	60619	1	0.20	-
UV LP-20/25/30 quartz (lamps 75 W and 90 W)	60631	1	0.09	-

LS/S Neolysis electrodes



	Code	Standard Pack	Standard weight in kg	Standard volume in m ³
50 gr/h - 75 W Neolysis electrode (Codes 57753, 57763, 57766)	61119	1	-	-
80 gr/h - 90 W Neolysis electrode (Codes 57761, 57764, 57767)	61120	1	-	-
120 gr/h - 2 x 90 W Neolysis electrode (Codes 57762, 57765, 57768)	61121	1	-	-
180 gr/h - 3 x 90 W Neolysis electrode (Codes 68117, 68118, 68119)	68126	1	-	-

Heliox UV MP



INTRODUCTION

- + AstralPool presents Heliox UV, an automatic UVC light system, which guarantees double disinfection through a significant reduction in the amount of chloramines (bound chlorine) along with the neutralisation of bacteria, viruses and other microorganisms present in water by impeding their reproduction.
- + The range comprises the Heliox UV LP model for private pools, the Heliox UV MP for public pools.

The advantages of UV-C technology:

- + UV ray treatment systems are completely automatic, with very low maintenance and running costs. They also have considerable advantages over other systems:
- + 100% of pool water is treated.
- + The disinfected water is free of unpleasant smells and does not irritate the eyes, thanks to a drastic reduction in the amount of chloramines.
- + They save money as fewer chemical products are required.
- + They are environmentally friendly because:
 - + Less fresh water is needed (daily water renewal is reduced).
 - + Fewer waste by-products are formed, resulting in a reduction in subsequent water treatment.
 - + The UV-C equipment does not add any chemical products to the water.

Heliox-UV operation

- + UV-C disinfection is a local treatment (UV chamber), which takes place as the water in the pool circulates through the chamber that contains the UV-C lamps.
- + The accurate delivery of radiation (W UV-C) and residence time in the system ensure the effective neutralisation of 99.9% of microorganisms, as well as the reduction of chloramines to safe levels (<0.6 ppm).

Heliox UV MP



For sea water application, contact with AstralPool

- Heliox UV MP (medium pressure) systems are designed to be used in public pools. These lamps operate over a wide spectrum to cover the whole of the UV region (see graph), which makes possible the effective eradication of chloramines (<0.6 ppm) in the pool water and its efficient disinfection due to the neutralisation of microorganisms (99.9%), including those resistant to chlorine treatment.
- More compact design (UV reactor in AISI-316).
- Adjustable to between 70 and 100% of rated power, in 1% increments, by means of a self-cooling electronic ballast.
- Fluidra technology (design and manufacturing).
- Calibrated UV-C radiation sensor (mW/cm²). Precise dose control. Instant power adjustment to process conditions. Saves energy and extends the lamp's lifetime.
- Advanced colour touch screen. System menu for browsing process parameters and log files.
- All UV MP 50-->450 and UV MP 50AWP -> 450AWP models are built in compliance with UL NSF.

Advanced versions:

- Embedded web.
- The control architecture used in Heliox UV PM systems has a number of features that make them reliable, energy-efficient and scalable to the highest possible level.
- The Heliox UV MP systems use two parameters for adjusting the power setting: average radiation and flow. All models have a rated radiation profile that ensures a dose of 60mJ/cm². If the flow is lower than the rated value, the same will apply to the required radiation level and the system reduces the power input, thus optimising power consumption and the lamp's lifetime. Likewise, if radiation drops due to losses caused by cloudy water, scaling or lamp emission efficiency, the system will adjust the power so that the right dose is supplied.

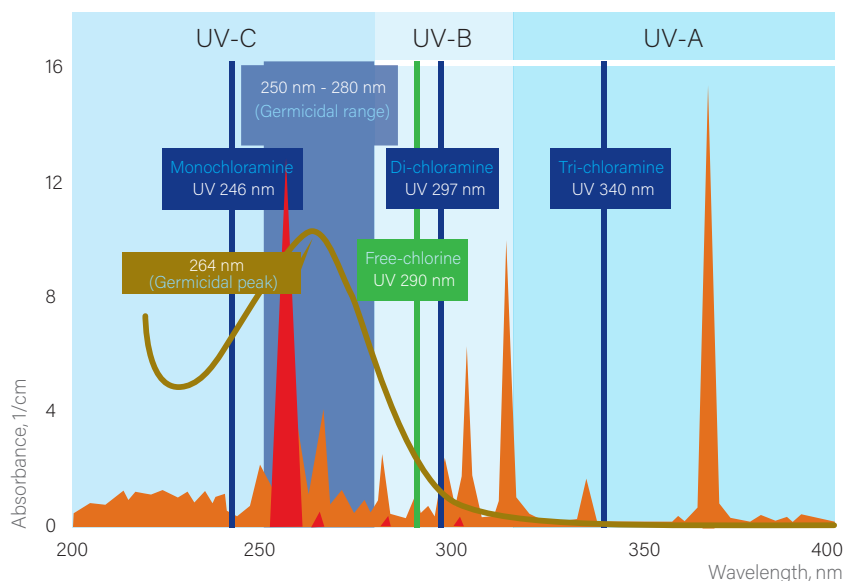

■ Medium pressure Heliox lamp spectral power distribution
■ Low pressure Heliox lamp spectral power distribution
■ DNA absorption (Germicidal curve)
■ Absorption range
■ Free chlorine absorption range



Heliox UV MP

	Code	Standard Pack	Standard weight in kg	Standard volume in m ³
Heliox UV MP 50	52200	1	-	-
Heliox UV MP 80	52201	1	-	-
Heliox UV MP 140	52202	1	-	-
Heliox UV MP 300	52203	1	-	-
Heliox UV MP 450	52204	1	-	-
Heliox UV MP 675	52205	1	-	-

Heliox UV MP Auto Wiper

Heliox UV MP 50 W	58808	1	-	-
Heliox UV MP 80 W	58809	1	-	-
Heliox UV MP 140 W	58698	1	-	-
Heliox UV MP 300 W	58810	1	-	-
Heliox UV MP 450 W	58699	1	-	-
Heliox UV MP 675 W	58811	1	-	-

Heliox UV MP lamps



	Code	Standard Pack	Standard weight in kg	Standard volume in m ³
Lamp UV MP 50/80 (Codes 52200, 52201, 58808, 58809)	60638	1	0.125	-
Lamp UV MP 140 (Codes 52202, 58698)	60639	1	0.255	-
Lamp UV MP 300/450/675 (Codes 52203, 52204, 52205, 58810, 58699, 58811)	60642	1	0.275	-
Quartz tube case MP 50/80/140	60643	1	0.050	-
Quartz tube case MP 300/450/675	60644	1	0.050	-

Heliox UV LP



+ UV LP Stainless Steel and UV LP PE (LP = low pressure) systems are designed to be used in public pools. They act at a wavelength of 254 nm, which is ideal for eliminating microorganisms. They will enable you to benefit from the latest ultraviolet light technology in the field of water treatment.

New Features of LP S.S. & LP PE:

- + Stainless steel and polyethylene versions.
- + Multi-lamp version.
- + Fluidra technology (design and manufacturing).
- + Lamp "ON" indicator.
- + Electronic counter for working time and ignitions (lamp lifetime control).
- + Flow switch included as standard.

Heliox UV LP S.S. (Stainless Steel)



	Code	Standard Pack	Standard weight in kg	Standard volume in m ³
145 S.S. 270 W / 90 W (UVC)	60344	1	-	-
165 S.S. 360 W / 120 W (UVC)	60345	1	-	-
185 S.S. 450 W / 150 W (UVC)	60346	1	-	-
195 S.S. 540 W / 180 W (UVC)	60347	1	-	-

Heliox UV LP PE (PolyEthylene)



	Code	Standard Pack	Standard weight in kg	Standard volume in m ³
P20EX PE 90 W / 30 W (UVC)	63138	1	-	-
P25EX PE 180 W / 60 W (UVC)	63139	1	-	-
P30EX PE 270 W / 90 W (UVC)	63140	1	-	-
P35 PE 270 W / 90 W (UVC)	60348	1	-	-
P45 PE 360 W / 120 W (UVC)	60349	1	-	-
P60 PE 450 W / 150 W (UVC)	60354	1	-	-
P70 PE 540 W / 180 W (UVC)	60358	1	-	-
P95 PE 680 W / 204 W (UVC)	63135	1	-	-
P140 PE 1020 W / 306 W (UVC)	63136	1	-	-
P180 PE 1360 W / 408 W (UVC)	64347	1	-	-
P220 PE 1700 W / 510 W (UVC)	64348	1	-	-
P260 PE 2040 W / 612 W (UVC)	64349	1	-	-
P300 PE 2380 W / 714 W (UVC)	63137	1	-	-

TECHNICAL FEATURES

Material	Code	Model	Flow rate (35 mJ/cm ²) Freshwater	Flow rate (35 mJ/cm ²) Seawater	Flow rate (60 mJ/cm ²) Freshwater	No. Lamps	Rated / UV-C power	Total height	Ø reactor
Stainless steel	60344	UV LP 45	45 m ³ /h	-	22 m ³ /h	3X90 w	90 UV-C (W)	1092	204
Stainless steel	60345	UV LP 65	65 m ³ /h	-	30 m ³ /h	4X90 w	120 UV-C (W)	1092	204
Stainless steel	60346	UV LP 85	85 m ³ /h	-	37 m ³ /h	5X90 w	150 UV-C (W)	1092	204
Stainless steel	60347	UV LP 95	95 m ³ /h	-	43 m ³ /h	6X90 w	180 UV-C (W)	1092	204
PE	60348	UV LP P35	35 m ³ /h	26 m ³ /h	18 m ³ /h	3X90 w	90 UV-C (W)	1020	250
PE	60349	UV LP P45	45 m ³ /h	33 m ³ /h	22 m ³ /h	4X90 w	120 UV-C (W)	1020	250
PE	60354	UV LP P60	60 m ³ /h	45 m ³ /h	30 m ³ /h	5X90 w	150 UV-C (W)	1020	250
PE	60358	UV LP P70	70 m ³ /h	53 m ³ /h	35 m ³ /h	6X90 w	180 UV-C (W)	1020	250
PE	63138	UV LP 20 EX	20 m ³ /h	15 m ³ /h	-	1X90 w	30 UV-C (W)	950	200
PE	63139	UV LP 25 EX	25 m ³ /h	19 m ³ /h	-	2X90 w	60 UV-C (W)	950	200
PE	63140	UV LP 30 EX	30 m ³ /h	23 m ³ /h	-	3X90 w	90 UV-C (W)	950	200
PE	63135	UV LP P95	101 m ³ /h	62 m ³ /h	-	2X340 w	204 UV-C (W)	1319	315
PE	63136	UV LP P140	152 m ³ /h	95 m ³ /h	-	3X340 w	306 UV-C (W)	1319	315
PE	64347	UV LP P180	198 m ³ /h	113 m ³ /h	-	4X340 w	408 UV-C (W)	1319	315
PE	64348	UV LP P220	242 m ³ /h	151 m ³ /h	-	5X340 w	510 UV-C (W)	1319	315
PE	64349	UV LP P260	283 m ³ /h	179 m ³ /h	-	6X340 w	612 UV-C (W)	1319	315
PE	63137	UV LP P300	327 m ³ /h	198 m ³ /h	-	7X340 w	714 UV-C (W)	1319	315

Heliox UV LP lamps

DESCRIPTION



	Code	Standard Pack	Standard weight in kg	Standard volume in m ³
90-W UV LP-25 lamp (Codes 60344, 60345, 60347, 63138, 63139, 63140, 60348, 60349, 60354, 60358)	60609	1	-	-
UV LP-20/25/30 quartz (lamps 75 W and 90 W)	60631	1	-	-
340 W UV LP lamp (Codes 63135, 63136, 64347, 64348, 64349, 63137)	66062	1	-	-
UV LP 1100MM quartz (Lamps 400 W)	66063	1	-	-

WATER TREATMENT EQUIPMENT

Exactus membrane

dosing pumps



DESCRIPTION

All systems comply with EC regulations. IP-65 protection. Electrical connection: 220/240 V 50/60 Hz. Materials in contact with the liquid: Polypropylene, Viton, Teflon and PVC. Other valve models in different materials available on request. Includes anti-acid plastic housing. Touch sensitive moisture resistant indicator. Drainage valve included. Lubrication-free, minimal maintenance. On request, the unit can be supplied with outlet, level sensor or other operating voltages.

Available materials:

Pump head: PP, and available in PVDF and PTFE to order

Diaphragm: PTFE

Valves: FPM lip valve (Viton) and other elastomers such as EPDM (Dutral), NBR (nitrile) and silicone available to order. Ceramic ball valves available.

Connections: 4 x 6 mm

Installation kit included with all pumps: full suction filter (PP-FPM by Viton), injection valve (PP-FPM by Viton), suction/return piping 2 m + 2 m PVC, 2-m PE distribution hose.

EXACTUS PUMP PERFORMANCE CURVE

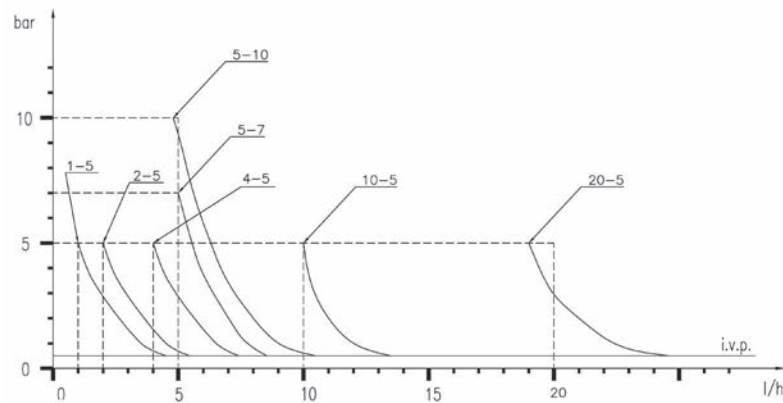

Exactus manual analog

DESCRIPTION

Electronic dosing pump for wall mounting or horizontal base. Manually regulated flow rate. Regulation range: 0-100% and 0-20%. Acid resistant plastic housing.

		Code	Standard Pack	Standard weight in kg	Standard volume in m ³
Manual Analog	2 l/h - 5 bar	57153	1	4	0.005
Manual Analog	2 l/h - 10 bar	57154	1	4	0.005
Manual Analog	5 l/h - 7 bar	57155	1	4	0.005
Manual Analog	5 l/h - 10 bar	57156	1	4	0.005
Manual Analog	10 l/h - 5 bar	57157	1	4	0.005
Manual Analog	20 l/h - 5 bar	57158	1	4	0.005

Exactus manual digital



DESCRIPTION

Electronic dosing pump for wall mounting or horizontal base. Manually regulated flow rate with digital control for injection frequency. 3 digit display. Regulation range: 0-100%, with a scale of 1%. Product ready to incorporate level sensor (not included). Acid resistant plastic housing.

		Code	Standard Pack	Standard weight in kg	Standard volume in m ³
Manual Digital	2 l/h - 5 bar	57159	1	4	0.005
Manual Digital	5 l/h - 7 bar	57160	1	4	0.005
Manual Digital	5 l/h - 10 bar	57161	1	4	0.005
Manual Digital	10 l/h - 5 bar	57162	1	4	0.005
Manual Digital	20 l/h - 5 bar	57163	1	4	0.005

Exactus Proportional



DESCRIPTION

Proportional pump controlled by the mA signal. The pump may be connected to a transmitter/indicator instrument or to another device that feeds in an intensity-modulated signal of 0 to 20mA. The frequency drive of the pump will be proportional to the mA signal received, i.e. the higher the signal, the greater the pump flow rate. The pump can be set to work in reverse mode, i.e. the higher the signal, the lower the flow rate. This model can be adapted for other mA rates (0-20mA, 4-20mA, 20-4mA). Product can incorporate a level sensor (sold separately).

		Code	Standard Pack	Standard weight in kg	Standard volume in m ³
Proportional (4-20mA)	5 l/h - 7 bar	57164	1	4	0.005
Proportional (4-20mA)	5 l/h - 10 bar	57165	1	4	0.005
Proportional (4-20mA)	10 l/h - 5 bar	57166	1	4	0.005
Proportional (4-20mA)	20 l/h - 5 bar	57167	1	4	0.005

Exactus pH / Rx



DESCRIPTION

Backlit LCD screen, ON / OFF or proportional operating modes, 0 ÷ 14 pH; -1000 ÷ 1400 mV, pH, RX (ORP) electrode inlet (10 Tera Ohm) (electrode not included), screen resolution: 0.01 pH; ± 1mV. Product can include a level sensor (not included).

		Code	Standard Pack	Standard weight in kg	Standard volume in m ³
pH / Rx	5 l/h - 7 bar	57892	1	4	0.005
pH / Rx	5 l/h - 10 bar	57893	1	4	0.005
pH / Rx	10 l/h - 5 bar	57894	1	4	0.005

Exactus Volumetric VFT



DESCRIPTION

Electronic dosing pump for mounting on base or wall. Proportional volumetric dosing pump that works from signals received from a flow meter. Can be operated in manual or automatic mode depending on the signals received. Product can incorporate a level sensor (sold separately)

		Code	Standard Pack	Standard weight in kg	Standard volume in m ³
Volumetric VFT	5 l/h - 7 bar	57174	1	4	0.005
Volumetric VFT	5 l/h - 10 bar	57175	1	4	0.005
Volumetric VFT	10 l/h - 5 bar	57176	1	4	0.005
Volumetric VFT	20 l/h - 5 bar	57177	1	4	0.005

pH sensor



DESCRIPTION

5-metre pH sensor with plastic BNC connector.

Code	Standard Pack	Standard weight in kg	Standard volume in m ³
21538	1	0.2	0.001

RX sensor



DESCRIPTION

5-metre RX sensor with plastic BNC connector.

Code	Standard Pack	Standard weight in kg	Standard volume in m ³
21539	1	0.3	0.001

pH sensor kit



DESCRIPTION

Includes pH sensor, buffer solutions, sensor holder, level sensor. For Exactus.

Code	Standard Pack	Standard weight in kg	Standard volume in m ³
56122	1	-	-

RX sensor kit



DESCRIPTION

Includes RX sensor, buffer solutions, sensor holder, level sensor. For Exactus.

Code	Standard Pack	Standard weight in kg	Standard volume in m ³
56124	1	-	-

CL sensor



DESCRIPTION

For CL Exactus model.

Code	Standard Pack	Standard weight in kg	Standard volume in m ³
45896	1	-	-

Sensor holder for chamber



Code	Standard Pack	Standard weight in kg	Standard volume in m ³
01305	1	0.3	0.001



Sensor holder (pressure)

DESCRIPTION

For working with pressure.

Code	Standard Pack	Standard weight in kg	Standard volume in m ³
01306	1	0.3	0.001

Optima dosing pumps

- + The OPTIMA dosing pump represents the development of more than 30 years of experience in the automatic dosing field.
- + This series reduces the number of pumps required to meet the various dosing needs.
- + The OPTIMA dosing pump series, with its power supply technology from 90, VCA to 265 VCA and at 50-60 Hz, ensures a precision and reliability never seen before.
- + Integration of many functions due to its simple programming, an alphanumeric display, the possibility of multilingual programming of the menu and a technology which permit controlled flow rate and back pressure.
- + Allows to use the same model for various applications providing a great versatility.
- + Systems manufactured in compliance with EC standards.
- + IP5 protection. 90-265V AC 50/60 Hz power supply.
- + Components in contact with chemicals are made of polypropylene, Viton, Teflon and PVC. (Other materials are available if made to order.)
- + Acid-resistant casing.
- + Moisture-resistant membrane push buttons.
- + Built-in purge valve.
- + No lubrication and little maintenance work required.
- + Sensors and calibration solutions not included.
- + Also available with a peristaltic pump (see page 728).

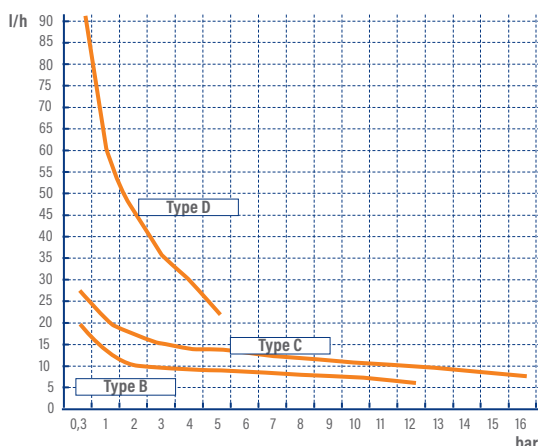

Sensors

pH sensor with calibration solutions (Code: 36004)				
Redox sensor with calibration solutions (Code: 36005)				

Optima constant flow rate



DESCRIPTION

In OPTIMA constant flow rate analogue dosing pumps, the flow rate can be set as a percentage using the potentiometer under the front panel, which modifies the pump's operation frequency.

The pumps in this range have an level inlet sensor.

Double scale adjustment: the maximum dosing frequency can be divided into 5. This double scale allows users to have two pumps with a single unit.

Power supply from 90 to 230 VCA at 50-60 Hz with plug and switch

	Code	Standard Pack	Standard weight in kg	Standard volume in m ³
Adjustable manual Optima pump				
B-type pump of 5-10 bar and 2-5 l/h	57132	1	3.5	0.01
C-type pump of 5 bar and 10 l/h	57133	1	4.5	0.01
D-type pump of 5 bar and 120 l/h	57135	1	4.5	0.01

Optima Next constant flow rate



DESCRIPTION

The flow rate is fully adjustable from the flow meter. Power supply from 90 to 230 VCA at 50-60 Hz without plug.

	Code	Standard Pack	Standard weight in kg	Standard volume in m ³
Adjustable Optima manual pump at 8 bar and 5 l/h	66164	1	-	-

Optima proportional and volumetric



DESCRIPTION

OPTIMA pumps provide all the functions of proportional dosing in a single model.

Features:

- Proportional with analogue signals 4 - 20 mA.
- Proportional with digital signals and the possibility of:
- Multiplying the input impulses (1:n)
- Dividing the input impulses (n:1)
- Function in ppm
- The pump has a memory function for processing input impulses dosing
- Level alarm with pump disconnection.
- Maximum dosing flow rate to prevent overdosing.
- Password for protecting programmed data
- Possibility of alarm connection
- Power supply from 90 to 265 VCA at 50-60 Hz with plug

	Code	Standard Pack	Standard weight in kg	Standard volume in m ³
Type B Model 7-10 bar and 5 litres	57136	1	3.5	0.01
Type C Model 5 bar and 10 litres	57137	1	4.5	0.01
Type D Model 5 bar and 20 litres	57138	1	4.5	0.01

Optima Next proportional and volumetric



DESCRIPTION

OPTIMA pumps provide all the functions of proportional dosing in a single model.

Features:

- Proportional with analogue signals 4 - 20 mA.
- Reading of pulses/minute.
- Chemical product minimum level inlet.
- Pulse entry for dosing proportional from pulse emitter counter.
- Remote start/stop.
- Power supply from 90 to 265 VCA at 50-60 Hz without plug.

	Code	Standard Pack	Standard weight in kg	Standard volume in m ³
Model 8 bar and 5 litres	66165	1	-	-



Optima pH / Redox

DESCRIPTION

OPTIMA dosing pump with built-in pH/Redox control. pH/Redox instrument.

Automatic calibration: Calibration by simply pressing a button, with the possibility of controlling the level of sensor efficiency.

Features:

- 90-265 VAC 50/60 Hz power supply
- Manual temperature compensation for pH or optionally automatic via Pt100.
- 4-20mA output for printed register or transmission of the reading.
- Level alarm with pump disconnection or simple warning of lack of product by means of the alarm relay.
- Alarm notifying deactivation of the programmable setpoint across whole of the measurement range.
- Dosing delay time to stop the dosing pump from injecting product in event of sensor malfunction.
- Maximum dosing pump flow rate for preventing overdosing.
- Password for protecting programmed data.
- Possibility of alarm connection.

	Code	Standard Pack	Standard weight in kg	Standard volume in m ³
Type C Optima Redox/pH control dosing pump (10 bar and 5 l/h and 5 bar and 10 l/h)	66179	1	4.5	0.01
Optional:				
PT100 sensor	66758	-	-	-
Flange for PT100	66759	-	-	-



Sensor not included (see sensors on page 725)
Sensor holder not included (code 01306)

Optima Next pH / Redox



Sensor not included
(see sensors on page 725)
Sensor holder not included
(code 01306)

DESCRIPTION

OPTIMA dosing pump with built-in pH/Redox control instrument.

Automatic calibration by simply pressing a button, with the possibility of controlling the degree of sensor efficiency.

Features:

- Power supply from 90 to 265 VCA at 50-60 Hz without plug
- Manual temperature adjustment for pH or optional automatic adjustment with PT100 (sensor not included).
- Level control input.
- Remote off control.

	Code	Standard Pack	Standard weight in kg	Standard volume in m ³
Optima Next dosing pump redox control/pH control at 8 bar and 5 l/h	66166	1	-	-

Optima bracket for mounting above tank



DESCRIPTION

Optional bracket for mounting the OPTIMA series and pH Basic Plus in a horizontal position, for example on top of a chemical products tank.

	Code	Standard Pack	Standard weight in kg	Standard volume in m ³
	36830	1	0.1	0.002

Peristaltic dosing pumps



DESCRIPTION

90/260V 50/60 Hz electrical connection.

The installation kit includes:

- Transparent glass-type flexible 2-m PVC suction pipe.
- Semi-rigid white polyethylene 2-m return pipe.
- 3/8" BSP m. injection valve.
- Pool floor filter.

	Code	Standard Pack	Standard weight in kg	Standard volume in m ³
Peristaltic pump 4 l/h (3 bar)	57179	1	-	-
Peristaltic pump 12 l/h (1 bar)	57178	1	-	-

Polyethylene cylindrical tanks



DESCRIPTION

To hold chemicals for dosage pumps.

	Code	Standard Pack	Standard weight in kg	Standard volume in m ³
Capacity: 125 l	01314	1	4.5	0.120
Capacity: 250 l	01315	1	10.0	0.390
Capacity: 350 l	01316	1	14.0	0.510
Capacity: 500 l	01317	1	21.5	0.760
Capacity: 1000 l	28831	1	-	-

Manual stirrer



DESCRIPTION

For Polyethylene tanks.

	Code	Standard Pack	Standard weight in kg	Standard volume in m ³
Length 60 cm	01318	1	0.5	0.010
Length 90 cm	01319	1	1.2	0.020

CONTINUOUS FLOCCULATION SYSTEM

Floc System



DESCRIPTION

Automation flocculant dosing adjustable flow water pools. Includes: adjustable pump from 151 cm³/h until 1.5 l/h, injector valve, bottom filter, suction and return tube.

	Code	Standard Pack	Standard weight in kg	Standard volume in m ³
	54528	1	1	0.0044

WATER METERS

Woltman type turbine meters



DESCRIPTION

Woltman type axial turbine water meter, with numerical counter readout, and numbered drums. Dry dial with magnetic transmission. Easily removable gearwork and turbine. Pre-set for pulse emission. IP-68 protection level. CYBLE type pulse emission.

	Code	Standard Pack	Standard weight in kg	Standard volume in m ³
2" gauge - 50 mm	20430	1	12.0	0.004
2½" gauge - 65 mm	20431	1	13.6	0.004
3" gauge - 80 mm	20432	1	14.6	0.004
4" gauge - 100 mm	20433	1	20.0	0.006
5" gauge - 125 mm	20434	1	30.0	-
6" gauge - 150 mm	20435	1	36.0	0.009
8" gauge - 200 mm	20436	1	55.0	0.012
CYBLE type emitter K= 1 l/pulse	23235	1	-	-
CYBLE type emitter K= 10 l/pulse	23235-0010	1	-	-
CYBLE type emitter K= 100 l/pulse	23235-0100	1	-	-

AP PR-200

Compatible with water electrolysis



60359



60361



60362



*** Models with Cl₂ ppm: seawater can be used by substituting the gel electrolyte supplied with the standard unit for the gel electrolyte specifically for seawater (code 64658), which must be ordered separately.**

DESCRIPTION

The expert's choice for dosing control. The built-in panels based on Series AP PR controllers provide the best solution for the plug & play devices pre-assembled on the panel. There are several versions for the control of the water's pH, ORP and FREE CHLORINE levels.

AP PR-200 equipment is compatible with the Easy Salt, ProChlore Salt and Neolysis ranges

This is also the recommended solution for experts whenever several chlorination systems must be controlled at the same time from a single control and regulation panel (multiple control through the TIP kit).

	Code	Standard Pack	Standard weight in kg	Standard volume in m ³
AP PR-206 pH/ORP	60359	1	-	-
AP PR-207 pH/Cl ₂ PPM*	60361	1	-	-
AP PR-204 Cl ₂ PPM*	60362	1	-	-
With integrated TRI KIT				
AP PR-204 pH/ORP *	60359-KIT TRI	1	-	-
AP PR-207 pH/Cl ₂ PPM *	60361-KIT TRI	1	-	-
AP PR-204 Cl ₂ PPM *	60362-KIT TRI	1	-	-
ECC1S Electrolyte / free chlorine sensor gel (seawater)	64658	1	-	-
Optional:				
TRI kit, 3-unit simultaneous control	70338	1	-	-

Control Connect

The smart multi-setting controller

DESCRIPTION

A range of multi-setting control panels with colour touchscreen. Easy and efficient control of water sanitation. Fully automated pool water treatment.

- Multi-function TFT colour touchscreen.
- 4 programmable timer relays and 4 digital inputs.
- Poolstation (Ethernet as standard).
- Fluidra Connect Compatible.



	Code	Standard Pack	Standard weight in kg	Standard volume in m ³
pH / ORP / Temp. with in-line sensor holder	71537	1	5.85	-
pH / ORP / Temp. with panel sensor holder	71538	1	6.85	-
pH / Cl (ppm) Temp. with panel sensor holder	71539	1	6.85	-



71537



71538



71539

Amperometric Chlorine Sensors



	Code	Standard Pack	Standard weight in kg	Standard volume in m ³
Free Chlorine Sensor	60645	1	0.22	-
ECC1 Electrolyte / Gel for Organic Chlorine Sensor	60646	1	0.07	-
Membrane for CL.01.02 Inorganic Chlorine Sensor	60647	1	0.02	-
ECC1S Electrolyte / free chlorine sensor gel (Salt water)	64658	1	0.02	-

pH / ORP Sensors



	Code	Standard Pack	Standard weight in kg	Standard volume in m ³
pH combined sensor	60648	1	0.20	-
ORP sensor	60649	1	0.20	-

Calibration Solutions



	Code	Standard Pack	Standard weight in kg	Standard volume in m ³
Buffer solution pH 7.0 - 50 mL (Green)	60618	1	0.053	-
Buffer solution pH 4.0 - 50 mL (Red)	60632	1	0.058	-
Calibration solution 470 mV - 50 mL	60633	1	0.060	-

Pool Patrol



DESCRIPTION

The Colorimetric controller unit gives a reply to the demand of the Swimming Pool Market requiring compact, easy and low maintenance device, with IP65 enclosure. The available measures are: Free Chlorine (DPD1), pH, Redox (ORP), Temperature. Thanks to its internal graphic display it is possible to have all measures displayed at the same time. The Plastic Cover assures an easy accessibility to the hydraulic part.
Includes: Measuring instrument, flow detector by temperature, pH sensor, ORP sensor, pH calibration solutions, ORP calibration solutions and DPD2 bottle.

	Code	Standard Pack	Standard weight in kg	Standard volume in m ³
Pool Patrol	54527	1	-	-

Guardian Pool

+ A fully automated electronic control unit with potentiometric measurements of pH and Redox potential or an amperometric measurement selective chlorine



72700

72701

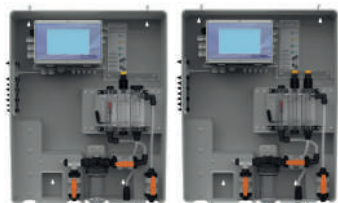

72702

72703

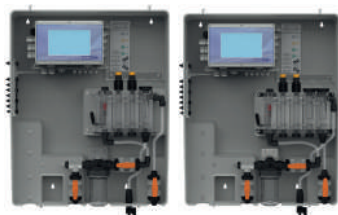

72704

72705

DESCRIPTION

The new Guardian Pool unit combines traditional control and dosing elements with a total digital control of its values that facilitates the management of the pool parameters, as well as its history to analyse or detect possible errors. Guardian Pool stands out for its high performance in the control and regulation of chemical products for use in private pools and public pools. Innovative design 7" high resolution touch screen display, firmware update through its USB port, which is also used for downloading the swimming pool data, and a great feature is the WIFI communication, to control the equipment through any mobile device, tablet or PC, inside its radius of range.

Advantages:

- New intuitive and user friendly multilingual user interface.
- Depending on model, simultaneous readings of pH, ORP, Temperature, Free Chlorine, Total Chlorine, Combined Chlorine and Turbidity.
- Internal datalogger with 4Mb of memory, up to 16,000 records, with the possibility of downloading data, displaying graphs and displaying the screen at the time of data input.
- Display of alarms by parameter.
- Chlorine measurement sensor, using Sodium Hypochlorite, Dichlor, Trichlor or Salt Chlorine, with stable reading up to 500 ppm of Isocyanuric Acid.
- Possibility to use electrodes for Bromine, Peroxide, Peracetic, Ozone
- 2 control relays for pH and Free Chlorine parameters, powered at 230V 50/60Hz 6A.
- 1 control relay powered for ORP at 230V 50/60Hz 6A.
- 1 control relay for Temperature 230V 50/60Hz with the possibility of associating it to Total Chlorine or Combined Chlorine.
- 2 alarm relays, potential free, configurable to any measurement, including flow rate, or as a general system alarm.
- RS485 Modbus Fluidra Connect RS485 communication port.
- Electrode holder with LED lighting for failure identification.

Technical Specifications:

- Innovative design.
- 7" touch screen (240x128 pixels backlit display).
- Modular probe holder
- Digital central with full access to all its parameters.
- Easy to use.
- For pools dosed with stabilized chlorine (solid), non-stabilized chlorine (liquid or solid), or bromine.
- Includes double relay outputs for each parameter, adjustable 4-20 mA outputs
- WiFi module with internal Webserver page settings
- Fluidra connect compatible
- Multilingual menu
- The signal inputs of the sensors are galvanically isolated.
- USB port for download parameter and Firmware upgrade function.
- Adjusting the proportional dosage on proportional pump .



Fluidra Connect compatible



	Code	Standard Pack	Standard weight in kg	Standard volume in m ³
Guardian Pool 1	72700	1	-	-
Guardian Pool 2	72701	1	-	-
Guardian Pool 3	72703	1	-	-
Guardian Pool 4	72702	1	-	-
Guardian Pool 5	72704	1	-	-
Guardian Pool 6	72705	1	-	-

Model	Guardian Pool 1	Guardian Pool 2	Guardian Pool 3	Guardian Pool 4	Guardian Pool 5	Guardian Pool 6
	Chlorine 10 ppm	Chlorine 2 ppm	pH / ORP	pH / Chlorine 10 ppm	pH / ORP / °C / Chlorine 10 ppm ⁽¹⁾	pH / ORP / °C / Free and Total Chlorine 10 ppm / NTU ⁽¹⁾
Code	72700	72701	72703	72702	72704	72705
Water uses	Drinking water	Drinking water	Residential / Commercial Pools	Commercial Pools	Commercial Pools	Commercial Pools
Sensors	pH		✓	✓	✓	✓
	ORP ⁽²⁾		✓		✓	✓
	Temperature	✓	✓	✓	✓	✓
	Free Chlorine 2 ppm		✓			
	Free Chlorine 10 ppm	✓			✓	
	Total Chlorine 10 ppm					✓
	Combined Chlorine					✓
Turbidity 10 NTU						✓

(1) PT-100 temperature sensor included. (2) ORP probe with gold cathode (Au).

Controller



DESCRIPTION

The panels in the CONTROLLER range are fully equipped and assembled systems. They are therefore ideal for use in water treatment.

Their simple, compact design makes installation and start-up extremely easy.

They come with all of the components and accessories required for rapid assembly. All assemblies are made of PVC sheets, in various sizes depending on the model.

General technical features

- Range of available sizes depending of the sensor selected.
- Range available for free chlorine: 0-2, 0-5 0-10, 0-20 and 0-200 ppm.
- pH range: 0-14.
- ORP range: +/-1500 mV.
- Temperature range: 0-50°C.
- Measurement of stable chlorine with low pH dependence.
- Self-calibration of all sizes.
- Alarm signal if water flow is insufficient.
- Instrument with IP65 protection rating.
- 250 V-10 A relays for connecting dosing pumps or salt chlorinators.
- 4-20 mA analogue outlets with repeat signal or manifold for proportional pumps.
- Power supply: 230 V / 50 Hz.
- Setpoints and programmable alarms.
- Pump pause function during calibration and for stopping flow.
- Temperature readings and readjustment (automatic with PT100 sensor included).
- Three types of setpoint settings. On/Off, Proportional in Time and Proportional by Pulses.
- RS485 communications port.

Components included in the assembly:

- Methacrylate sensor holder, with flow regulator, sample taking valve and flow sensor.
- Filter holder and 80 micron filter cartridge for water inlet.
- DPD calibration standard solutions.
- Assembly accessories, and instruction and installation manual.
- Sensors depending on version.



	Code	Standard Pack	Standard weight in kg	Standard volume in m ³
Controller pH / Redox	66178	1	-	-
Controller pH / Free Chlorine	66177	1	-	-
Controller pH / ORP / Free Chlorine	66176	1	-	-
Controller Free Chlorine	66175	1	-	-
pH/Amperometric-free chlorine sensor	66168	1	-	-
pH/ORP/Amperometric free chlorine sensor	66169	1	-	-
Controller pH / ORP / Free Chlorine / Total amperometric chlorine	66170	1	-	-

Installation diagram for organic Chlorine or Bromine

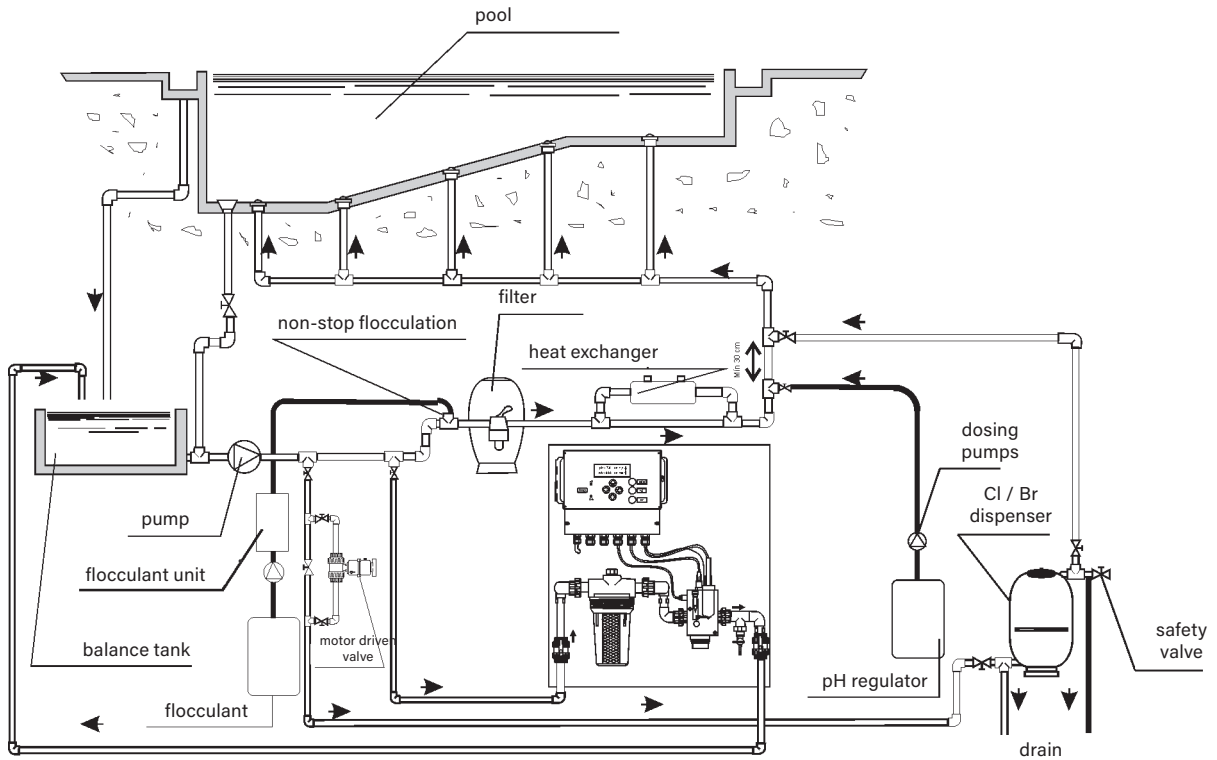

Installation diagram for Inorganic Chlorine

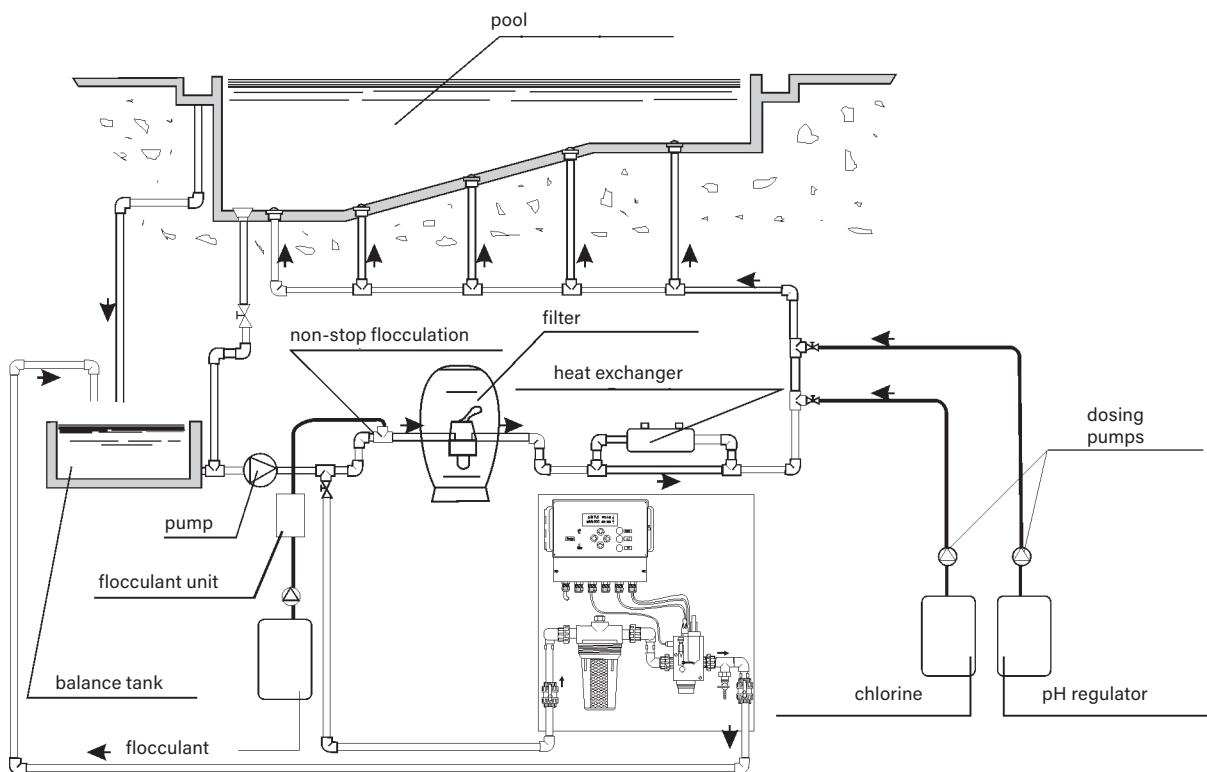

WATER TREATMENT EQUIPMENT





COMMERCIAL POOLS

SPAS AND SAUNAS



738	Spa range	754	Pool Jet accessories
738	Optional equipment	755	Accessories for minispas
740	In-ground overflow commercial spas	758	Electrical accessories for spas / mini spas
744	Stainless steel public spas with overflow channel	759	Air blowers
746	Stainless steel public spas	762	Saunas
747	Compact filtration for spas	767	Steam baths
748	Complements for spas	772	Emotional showers
750	Liner accessories	776	Nordic baths



Commercial spas with overflow channel and compact units

- + Spas designed for commercial spaces, gyms, wellness centres, hotels...
- + A wide range of options and finishes that cover all needs.
- + Spas with both an acrylic and mosaic tile finish.

Colour chart for spas

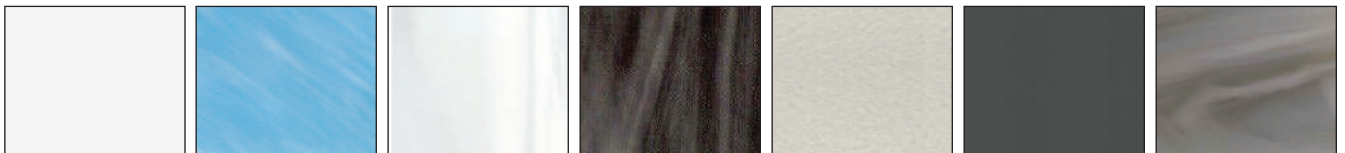

N° 44 WHITE

N° 46 BLUE MARBLE

N° 59 STERLING

N° 64 PEARL SHADOW

While stocks last

N° 72 PEARL CAMEO

While stocks last

N° 27 SILVER

N° 18 SAND

While stocks last

OPTIONAL EQUIPMENT

Chromotherapy LED spotlight, for public spas only







The Mini LED spotlight is the best option for lighting public spas. Thanks to the high intensity LEDs, lighting is similar to that attained with conventional lamps.

The range of LumiPlus Mini 2.0 projectors has a multitude of possible colour combinations and sequences with higher light intensity and better energy efficiency, which result in an 80% saving on electricity consumption compared with conventional projectors, as well as 100,000 hours of useful life time without the need for maintenance.

Chromotherapy LED spotlight option

Comparison of models with an overflow channel

					
MODELS	Roma	Verona	Tokyo 70	Olympia	Odisea 20
	40769	70550	53990	73587	45709
Size cm (± 2 cm)	Ø 300	228 x 228	340 x 240	365 x 280	Ø 230
Positions (Seats / Loungers)	9 (9 / -)	5 (3 / 2)	7 (6 / 1)	12 (12 / -)	5 (5 / -)
Water capacity (litres)	2,290 l	1,200 l	2,200 l	2,490 l	1,120 l
Spa weight Empty	310 Kg	147 Kg	373 kg	373 kg	163 kg
Spa weight Full	2,600 Kg	1,347 Kg	2,573 kg	2,863 kg	1,283 kg
Acrylic	•	•	•	•	•
Colours	44 / 46 / 59	44 / 59 / 74 / 64 / 46	44 / 59 / 74 / 64 / 46	44 / 46 / 59	44 / 59 / 74 / 64 / 46
No of jets	18	24	58	16	8
No of air nozzles	18	12	21	16	10
Headrests	-	-	2	-	-
Piezoelectric press buttons	2	2	3	2	2
High resistance metallic structure	•	•	•	•	•
Projector	•	•	•	•	•
Chromotherapy	Op. 1 LED	Op. 1 LED	Op. 4 LED	Op. 1 LED	Op. 1 LED
Isothermal cover	Op.	Op.	Op.	Op.	Op.
Recommended compact kit	Kit 75 2M	Kit 75 2M	Kit 75 3M	Kit 75 2M	Kit 50 or 75

							
MODELS	Mirage 40	Vulcano	Mercurio	Minerva	Venus	Neptuno	Zeus
	75546	43723	71470	71472	46027	71473	71474
Size cm (± 2 cm)	Ø 250	Ø 230	268 x 230	205 x 205	211 x 211	254 x 220	408 x 210
Positions (Seats / Loungers)	6 (6 / -)	6 (6 / -)	4 (2 / 2)	4 (2 / 2)	4 (2 / 2)	5 (5 / -)	7 (5 / 2)
Water capacity (litres)	1,410 l	1,300 l	2,000 l	1,200 l	1,230 l	1,200 l	2,650 l
Spa weight Empty	353 kg	350 kg	500 kg	650 kg	325 kg	400 kg	650 Kg
Spa weight Full	1,763 kg	1,650 kg	2,000 kg	1,850 kg	1,560 kg	1,600 kg	3,300 Kg
Mosaic	•	-	-	-	-	-	-
Colours	All	Stainless steel		Stainless steel			
No of jets	26	12	12	28	20	23	25
No of air nozzles	12	Equiv. to 15 nozzles	Equiv. to 32 nozzles	28	16	20	62
Headrests	-	-	•	2	2	-	•
Piezoelectric press buttons	2	•	•	2	2	2	3
High resistance metallic structure	•	•	•	•	•	•	•
Projector	•	•	•	5	4	3	2
Chromotherapy	Op. 1 LED	as standard	as standard	as standard	as standard	as standard	as standard
Isothermal cover	Op.	Op.	Op.	Op.	-	Op.	Op.
Recommended compact kit	Kit 75 2M	Kit 75	Kit 75	16412	05135	16412	Send inquiry

Roma - Code 40769



COLOUR: BLUE MARBLE (46)

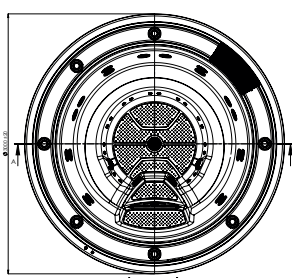

TECHNICAL FEATURES

Size in cm (± 2cm)	Ø 300 cm
Positions (Seats / Loungers)	9 (9 / -)
Jets + blower nozzles	18 + 18
Recommended compact kit	Kit 75 2M

Spa cover and balance tank sold separately. See section "Spa accessories".

Fully fitted with overflow channel, main drain, filtering, hydromassage and blower nozzles, hydromassage buttons and overflow grating. Balance tank not included.

	Code	Standard Pack	Standard weight in kg	Standard volume in m ³
ROMA + Light	40769SE001	-	-	-
ROMA + Light + Cover	40769SE006	-	-	-

Verona - Code 70550

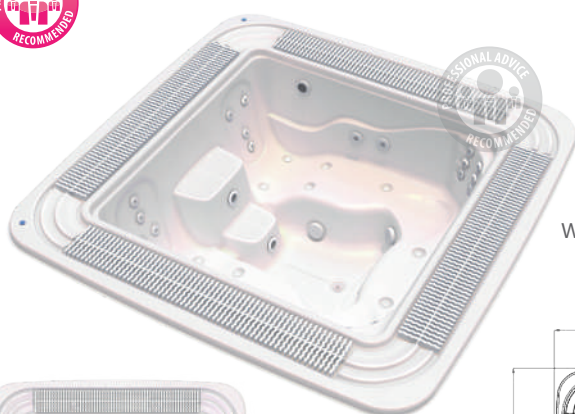

WHITE COLOUR (44)

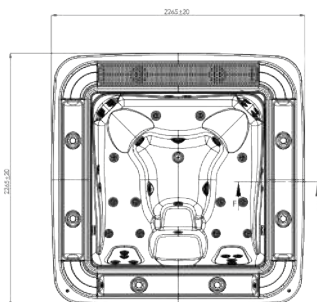

TECHNICAL FEATURES

Size in cm (± 2cm)	228 x 228 cm
Positions (Seats / Loungers)	5 (3 / 2)
Jets + blower nozzles	24 + 12
Recommended compact kit	Kit 75 2M

Spa cover and balance tank sold separately. See section "Spa accessories".

Fully fitted with overflow channel, main drain, filtering, hydromassage and blower nozzles, hydromassage buttons and overflow grating. Balance tank not included.

	Code	Standard Pack	Standard weight in kg	Standard volume in m ³
VERONA + Light	70550SE001	-	-	-
VERONA + Light + Cover	70550SE006	-	-	-

Tokyo 70 - Code 53990

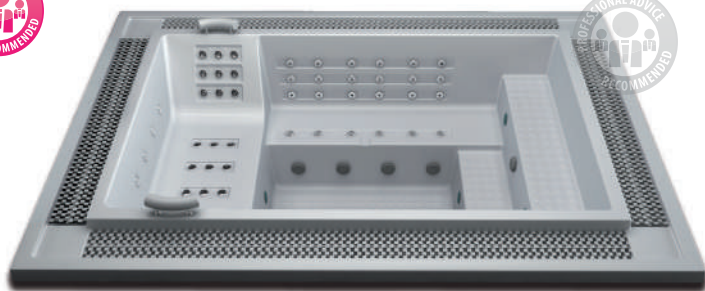

WHITE COLOUR
(44)

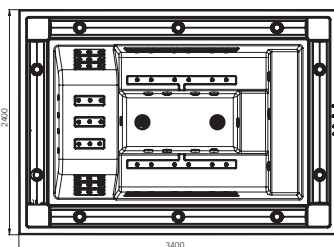

TECHNICAL FEATURES

Dimensions in cm (± 2cm)	340 x 240 cm
Positions (Seats / Loungers)	7 (6 / 1)
Jets + nozzles	58 + 21
Recommended compact kit	Kit 75 3M - Code 43639

Spa cover and balance tank sold separately. See section "Spa accessories".

Fully fitted with overflow channel, main drain, filtering, hydromassage and blower nozzles, hydromassage buttons and overflow grating. Balance tank not included.

	Code	Standard Pack	Standard weight in kg	Standard volume in m ³
Tokyo 70 + Light	53990SE315	-	-	-
Tokyo 70 + Light + Cover	53990SE316	-	-	-
Tokyo 70 Plus + Light + Cascade	53993SE315	-	-	-
Tokyo 70 Plus + Light + Cascade + Cover	53993SE316	-	-	-

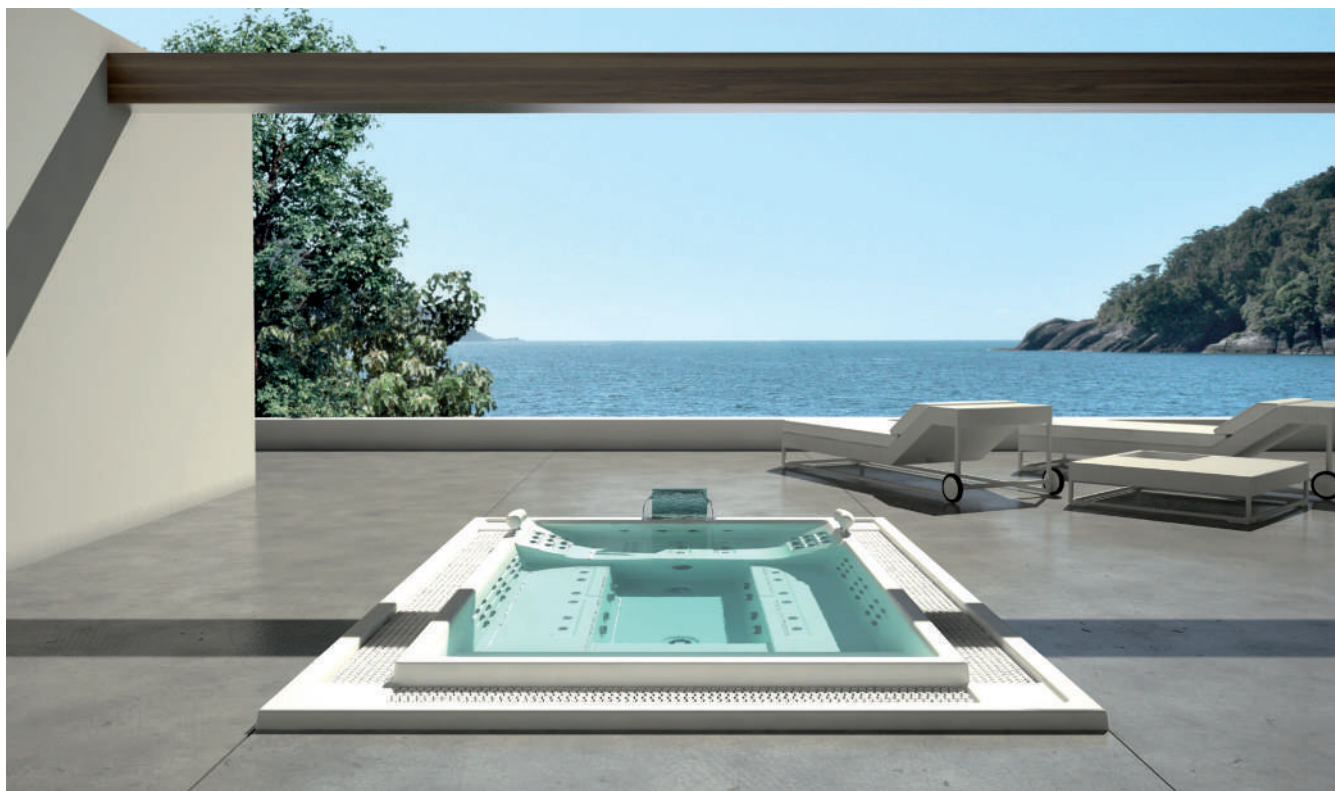

Olympia - Code 73587



BLUE MARBLE COLOUR (46)

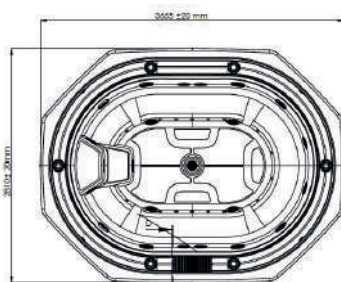

TECHNICAL FEATURES

Size in cm (± 2cm)	365 x 280 cm
Positions (Seats / Loungers)	12 (12 / -)
Jets + nozzles	16 + 20
Recommended compact kit	Kit 75 2M - Code 16412

This Spa is only available in colours 44, 46 and 59.

Spa cover and balance tank sold separately. See section "Spa accessories".

Fully fitted with overflow channel, main drain, filtering, hydromassage and blower nozzles, hydromassage buttons and overflow grating. Balance tank not included.

Olympia + Light
Olympia + Light + Cover

Code	Standard Pack	Standard weight in kg	Standard volume in m ³
73587SE001	-	-	-
73587SE006	-	-	-

Odisea 20 - Code 45709



WHITE COLOUR (44)

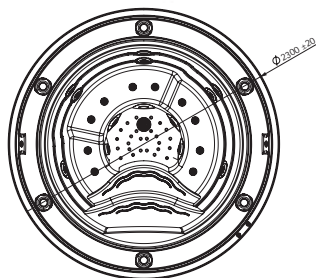

TECHNICAL FEATURES

Size in cm (± 2cm)	Ø 230 cm
Positions (Seats / Loungers)	5 (5 / -)
Jets + nozzles	8 + 10
Recommended compact kit	Kit 50 - Code 04015 / Kit 75 - Code 05135

Spa cover and balance tank sold separately. See section "Spa accessories".

Fully fitted with overflow channel, main drain, filtering, hydromassage and blower nozzles, hydromassage buttons and overflow grating. Balance tank not included.

Odisea 20 + Light
Odisea 20 + Light + Cover

Code	Standard Pack	Standard weight in kg	Standard volume in m ³
45709SP001	-	-	-
45709SP006	-	-	-

Mirage 40 - Code 75546



TECHNICAL FEATURES

Size in cm (± 2cm)	Ø 250 cm
Positions (Seats / Loungers)	6 (6 / -)
Jets + nozzles	26 + 12
Recommended compact kit	Kit 75 2M - Code 16412

Spa cover and balance tank sold separately. See section "Spa accessories".

Fully fitted with overflow channel, main drain, filtering, hydromassage and blower nozzles, hydromassage buttons and overflow grating. Balance tank not included.

Available colours:

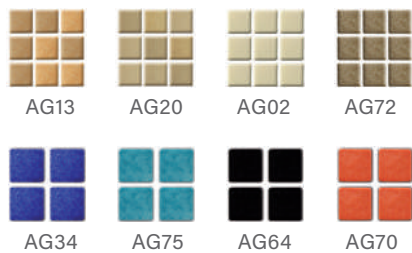

Code	Standard Pack	Standard weight in kg	Standard volume in m ³
Mirage 40 + Stainless steel jets + Colour LEDs + press buttons	75546SP315	-	-
Mirage 40 + Stainless steel jets + Colour LEDs + press buttons + Cover	75546SP316	-	-

Vulcano - Code 43723

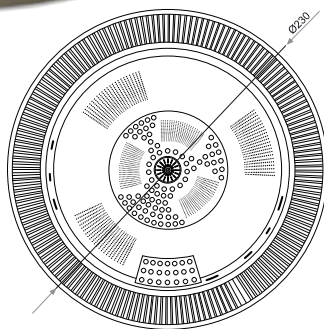

TECHNICAL FEATURES

Dimensions in cm (± 1cm)	Ø 230 x 90
Positions (Seats / Loungers)	6 (6 / -)
Jets + nozzles	12 + 15
Recommended compact kit	Kit 75 - Code 05135

Spa cover and balance tank sold separately. See section "Spa accessories".

Equipped with overflow channel, main drain, hydromassage push buttons, and filtration, hydromassage and blower nozzles. Buffer tank not included.

Code	Standard Pack	Standard weight in kg	Standard volume in m ³
------	---------------	-----------------------	-----------------------------------

VULCANO circular stainless steel SPA + Spotlight

43723

-

-

-

Mercurio - Code 71470

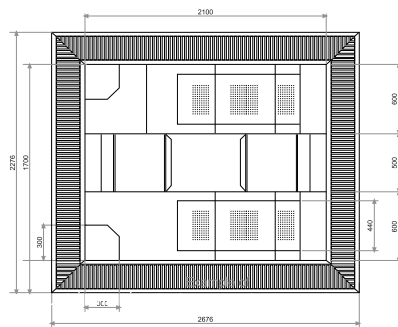

TECHNICAL FEATURES

Dimensions in cm (± 1cm)	268 x 230 x 90
Positions (Seats / Loungers)	4 (2 / 2)
Jets + nozzles	12 + 29
Recommended compact kit	Kit 75 - Code 05135

Spa cover and balance tank sold separately. See section "Spa accessories".

Equipped with overflow channel, main drain, hydromassage push buttons, and filtration, hydromassage and blower nozzles. Buffer tank not included.

Code	Standard Pack	Standard weight in kg	Standard volume in m ³
------	---------------	-----------------------	-----------------------------------

MERCURIO Rectangular Stainless steel SPA + Spotlight

71470

-

-

-

STAINLESS STEEL PUBLIC SPAS WITH OVERFLOW CHANNEL

Minerva - Code 71472

ASTRALPOOL 

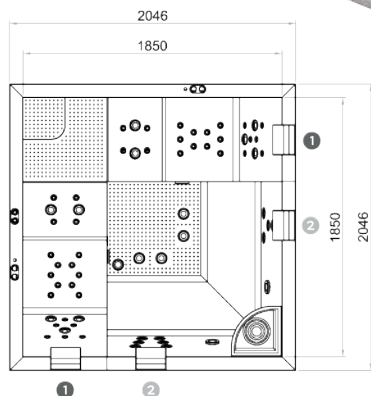

TECHNICAL FEATURES

Dimensions in cm (± 1cm)	205 x 205 x 90,5
Positions (Seats / Loungers)	4 (2 / 2)
Jets + nozzles	2 + 29
Recommended compact kit	Kit 75 - Code 05135

Spa cover and balance tank sold separately. See section "Spa accessories".

Equipped with overflow channel, main drain, hydromassage push buttons, and filtration, hydromassage and blower nozzles. Buffer tank not included.

Code	Standard Pack	Standard weight in kg	Standard volume in m ³
------	---------------	-----------------------	-----------------------------------

MINERVA Design Stainless steel SPA + Spotlight

71472

Venus - Code 46027

ASTRALPOOL 

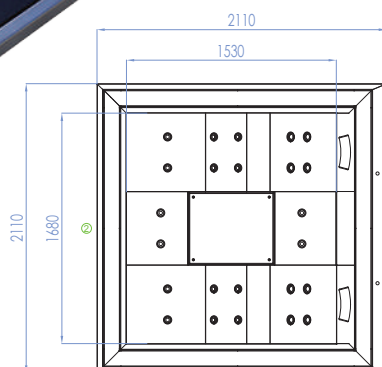
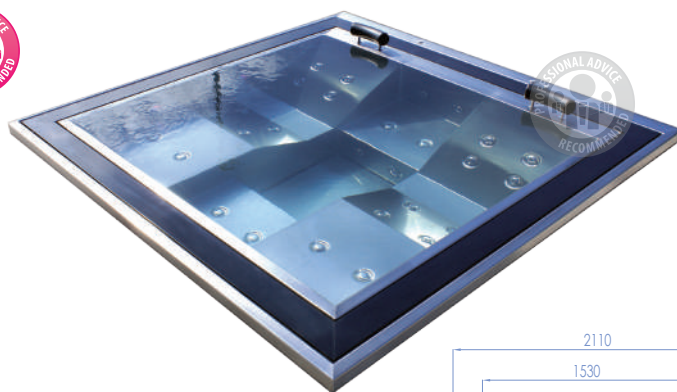

TECHNICAL FEATURES

Dimensions in cm (± 1cm)	211 x 211 x 90
Positions (Seats / Loungers)	4 (2 / 2)
Jets + nozzles	20 + 16
Recommended compact kit	Kit 75 - Code 05135

Spa cover and balance tank sold separately. See section "Spa accessories".

Equipped with overflow channel, main drain, hydromassage push buttons, and filtration, hydromassage and blower nozzles. Buffer tank not included.

Code	Standard Pack	Standard weight in kg	Standard volume in m ³
------	---------------	-----------------------	-----------------------------------

VENUS Rectangular Stainless steel SPA + Spotlight

46027

SPAS AND SAUNAS

Neptuno - Code 71473

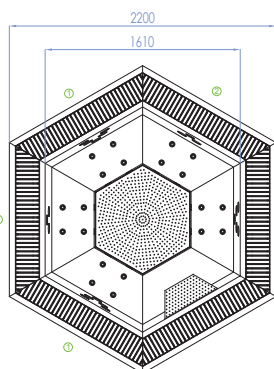

TECHNICAL FEATURES

Dimensions in cm (± 1cm)	254 x 220 x 100
Positions (Seats / Loungers)	5 (5 / -)
Jets + nozzles	23 + 20
Recommended compact kit	16412

Spa cover and balance tank sold separately. See section "Spa accessories".

Equipped with overflow channel, main drain, hydromassage push buttons, and filtration, hydromassage and blower nozzles. Buffer tank not included.

Code	Standard Pack	Standard weight in kg	Standard volume in m ³
71473	-	-	-

NEPTUNO Design Stainless steel SPA + Spotlight

Zeus - Code 71474

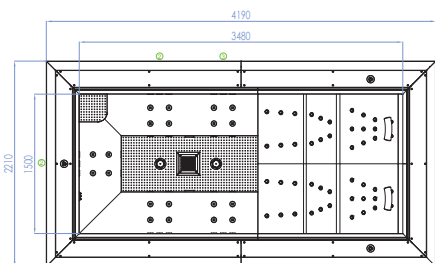
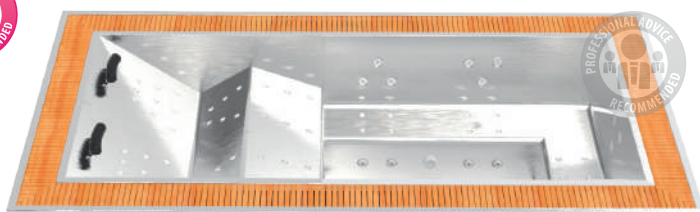

TECHNICAL FEATURES

Dimensions in cm (± 1cm)	348 x 150 x 98
Positions (Seats / Loungers)	7 (5 / 2)
Jets + nozzles	25 + 62
Recommended compact kit	Send inquiry

Spa cover and balance tank sold separately. See section "Spa accessories".

Equipped with overflow channel, main drain, hydromassage push buttons, and filtration, hydromassage and blower nozzles. Buffer tank not included.

Code	Standard Pack	Standard weight in kg	Standard volume in m ³
71474	-	-	-

ZEUS Rectangular Stainless steel SPA + Spotlight

COMPACT FILTRATION FOR SPAS

Compact kits for public use



16412



04015

Code Standard Pack Standard weight in kg Standard volume in m³

Compact kit

04015CE000	-	-	-
04015CE001	-	-	-
04015CE004	-	-	-
05135CE000	-	-	-
05135CE001	-	-	-
05135CE004	-	-	-
16412CE000	-	-	-
16412CE001	-	-	-
16412CE004	-	-	-
43639CE001	-	-	-
43639CE004	-	-	-

TECHNICAL FEATURES

	04015CE000	04015CE001	04015CE004	05135CE000	05135CE001	05135CE004	16412CE000	16412CE001	16412CE004	43639CE001	43639CE004
Spa Model	Odisea 20, Verona			Odisea 20, Verona			Roma, Coliseum, Olympia, Mirage 40			Tokyo 70	
Compact weight (with assembly)	114 kg			94 kg			116 kg			134 kg	
Filter weight (with assembly)	Included			85 kg			85 kg			85 kg	
Assembly volume compact kit	1.39 m ³			1.39 m ³			1.39 m ³			1.39 m ³	
Volume with filter	-			0.83 m ³			0.83 m ³			0.83 m ³	
Filter Ø	Ø 500 mm			Ø 650 mm			Ø 650 mm			Ø 650 mm	
Filter pump	0.60 kW			0.82 kW			0.82 kW			0.82 kW	
Filter pump flow rate	10000 l/h			11000 l/h			11000 l/h			11000 l/h	
Massage pump	1.40 kW			1.40 kW			2 x 1.81 kW			2 x 1.81 kW + 1 x 2.70 kW	
Blower pump	1.3 kW			1.3 kW			1.3 kW			1.3 kW	
Electric heater	6 kW		-	6 kW		-	6 kW		-	6 kW	
Voltage	400 AC III + N			400 AC III + N			400 AC III + N			400 AC III + N	
Power requirements	9362 W (18.1 A)		3350 W (5.6 A)	9582 W (19.2 A)		3570 W (6 A)	11802 W (23 A)		5790 W (9.7 A)	14485 W (27.5 A) 8473 W (14.2 A)	
Kit size without assembly (PrxAnxAI)	1160 x 1000 x 1200 mm			1160 x 1000 x 1200 mm			1160 x 1000 x 1200 mm			1160 x 1000 x 1200 mm	
Ozone	•			•			•			•	
Water-water exchanger 20 kW	•			•			•			•	

We reserve the right to change, wholly or partially, the features of our products and the contents of this document, without prior notice



Covers for spas



	Code	Standard Pack	Standard weight in kg	Standard volume in m ³
ODISEA 20 / Infinity spa cover	45721	1	20	0.25
OLYMPIA spa cover	73587	1	15	0.44
MIRAGE spa cover	41892	1	15	0.44
TOKYO spa cover	54184	1	-	-
VERONA spa cover	71194	1	18	0,86
ROMA spa cover	62402	1	18	0,86



Cover Stand

DESCRIPTION

Metal Stand for simple handling of the cover.

	Code	Standard Pack	Standard weight in kg	Standard volume in m ³
	28462	1	10	0.118

Spa access steps

	Code	Standard Pack	Standard weight in kg	Standard volume in m ³
Basic staircase coastal grey	60194	1	5	0.07
Swimspa staircase	56918CL01	1	35	0.59
Synthetic wood staircase				
In Graphite	42002CL0K	1	15	0.09
In Thunder	42002CL0R	1	15	0.09
In Creek	42002CL0T	1	15	0.09
In Butterfly	42002CL0W	1	15	0.09

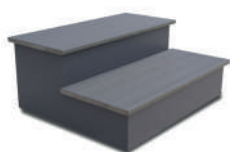

42002CL0K



60194



56918CL01

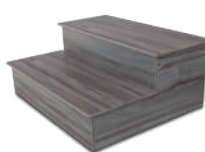

42002CL0R



42002CL0T



42002CL0W

Spa parasol in Cameo with LED



	Code	Standard Pack	Standard weight in kg	Standard volume in m ³
Spa parasol in Cameo with LED	60220	2	15	2

Portable spa handrail holder



	Code	Standard Pack	Standard weight in kg	Standard volume in m ³
Portable spa handrail holder	60226	2	8	0.95

Spa filter cartridge cleaner



	Code	Standard Pack	Standard weight in kg	Standard volume in m ³
Spa filter cartridge cleaner	60197	1	2	0.04

Polyester balance tank



DESCRIPTION

Used for collecting water volume displaced in overflow channel of commercial spas.

	Code	Standard Pack	Standard weight in kg	Standard volume in m ³
1000 litres capacity (162 x 122 x 83 cm)	11372	1	10.0	1.75
2000 litres capacity (204 x 160 x 75 cm)	27865	1	15.0	3.81

PE balance tank



DESCRIPTION

1000 litres capacity. Used for collecting water volume displaced in overflow channel of commercial spas.

	Code	Standard Pack	Standard weight in kg	Standard volume in m ³
158 x 92 x 95 cm	17144	1	10.0	1.75

TECHNICAL FEATURES

Code	Balance tank	Spa model
11372	1000 litre polyester tank	Casiopea, Formentera, Venecia, Coliseum, Odisea 20, Mirage 40
17144	1000 litre polyethylene tank	
27865	2000 litre polyester tank	Olympia, Wellmax, Casiopea, Formentera, Venecia, Coliseum, Odisea 20, Mirage 40

Different compensation vessel capacities depending on model:

2 ½" adjustable jet



DESCRIPTION

Regulates proportion of air-water outlet. 50 mm diameter water inlet and 32 mm air inlet. Flow: 4 m³/hour. Pressure 0.8 a.t.m.

Code	Standard Pack	Standard weight in kg	Standard volume in m ³
32641	12	7.625	0.028

2" threaded jet



DESCRIPTION

Water inlet diameter of 50 mm and air inlet diameter of 32 mm. Flow rate of 4 m³/hour. Atm pressure of 0.8.

Code	Standard Pack	Standard weight in kg	Standard volume in m ³
33586	12	7.625	0.028

2" jet thread for liner



DESCRIPTION

Water inlet diameter of 50 mm and air inlet diameter of 32 mm. Flow rate of 4 m³/hour Atm pressure of 0.8.

Code	Standard Pack	Standard weight in kg	Standard volume in m ³
70532	12	7.625	0.028

2" main drain



DESCRIPTION

With elbow for gluing to Ø 50 mm pipe.

Code	Standard Pack	Standard weight in kg	Standard volume in m ³
04042	15	4.8	0.028

Adjustable air inlet



DESCRIPTION

1" for air regulation to Venturi system for jet function.

Code	Standard Pack	Standard weight in kg	Standard volume in m ³
04045	25	6.0	0.028



Adjustable silent air inlet



DESCRIPTION

Silent Venturi for jet air flow control. Air intake is through embedded part. Attaches to air distributor code 33937.

Code	Standard Pack	Standard weight in kg	Standard volume in m ³
33938	25	8.5	0.028



5 outlet air distributor for Venturi system



DESCRIPTION

5 outlet air distributor for gluing to Venturi system with code 33938. Outlets for clamping a flexible hosepipe of 10 mm inner diameter.

Code	Standard Pack	Standard weight in kg	Standard volume in m ³
33937	25	8.5	0.028



6 outlet air distributor for Venturi system



DESCRIPTION

6 outlet air distributor to attach to pipes with a 10 mm inner diameter and glue to 15 mm pipes.

Code	Standard Pack	Standard weight in kg	Standard volume in m ³
33936	25	8.5	0.028



10 outlet air distributor



DESCRIPTION

10 outlet air distributor to attach to pipes with a 10 mm inner diameter and glue to 50 mm pipes.

Code	Standard Pack	Standard weight in kg	Standard volume in m ³
35346	25	8.5	0.028

4 water outlet manifold



DESCRIPTION

Manifold for gluing to 50 mm pipe, 4 outlets for clamping a hosepipe of 20 mm inner diameter.

Code	Standard Pack	Standard weight in kg	Standard volume in m ³
33934	25	8.5	0.028

8 water outlet manifold



DESCRIPTION

Manifold for gluing to 50 mm pipe, 8 outlets for clamping a hosepipe of 20 mm inner diameter.

Code	Standard Pack	Standard weight in kg	Standard volume in m ³
33935	25	8.5	0.028

Threaded blower nozzle



DESCRIPTION

For air distribution into the SPA from the blowers. Flow rate 5.4 to 7.5 m³/h.

	Code	Standard Pack	Standard weight in kg	Standard volume in m ³
White plastic front panel	27602	80	1.6	0.03
Stainless steel front panel	43440	80	1.6	0.03

Blower nozzle for gluing



DESCRIPTION

For air distribution into the SPA from the blowers. Flow rate 5.4 to 7.5 m³/h.

	Code	Standard Pack	Standard weight in kg	Standard volume in m ³
White plastic front panel	28460	80	1.6	0.03
Stainless steel front panel	43441	80	1.6	0.03

Blower nozzle lateral outlet 3/8"



DESCRIPTION

For air distribution into the SPA from the blowers. Flow rate 5.4 to 7.5 m³/h.

	Code	Standard Pack	Standard weight in kg	Standard volume in m ³
White plastic front panel	34318	80	1.6	0.03
Stainless steel front panel	43442	80	1.6	0.03

2" return unit



DESCRIPTION

For return line and massage.

	Code	Standard Pack	Standard weight in kg	Standard volume in m ³
	04034	25	5.0	0.028

Adjustable air impulsion inlet



DESCRIPTION

For air distribution by means of the blowers. Maximum flow rate 18 m³/h.

	Code	Standard Pack	Standard weight in kg	Standard volume in m ³
	49818	12	4.24	0.021

Pneumatic push button



DESCRIPTION

For starting and stopping massage and hydromassage functions.

	Code	Standard Pack	Standard weight in kg	Standard volume in m ³
For max. 15 m	04047	20	0.5	0.028
For max. 7 m simple	04048	40	1.6	0.028
For max. 7 m simple, with thread	09667	20	0.5	0.028

Plastic tube

DESCRIPTION

For pneumatic signal from press button to switch. Inner Ø 3.5 mm.

	Code	Standard Pack	Standard weight in kg	Standard volume in m ³
	04054	50	3.33	0.006

Stainless steel accessories should not be used in pools with salt electrolysis systems

Rotating jet



DESCRIPTION

Flow rate 2 to 2.5 m³/h.

Code	Standard Pack	Standard weight in kg	Standard volume in m ³
20297	25	3.33	0.028

Twin rotating jet



DESCRIPTION

Flow rate 2 to 2.5 m³/h.

Code	Standard Pack	Standard weight in kg	Standard volume in m ³
20296	25	3.83	0.028

Rotating jet housing



Code	Standard Pack	Standard weight in kg	Standard volume in m ³
20299	15	3.33	0.028

Jet housing for linear pool



Code	Standard Pack	Standard weight in kg	Standard volume in m ³
63144	12	3.33	0.028

Moveable tube jet nozzle

to install in substitution of a fixed one



DESCRIPTION

Compatible with codes 20295 and 20299. Flow rate 2 to 2.5 m³/h.

Code	Standard Pack	Standard weight in kg	Standard volume in m ³
20298	1	0.8	0.001

2 1/2" wall conduit for rotating jet



DESCRIPTION

Made up of: The jet body, 20 cm wall conduit, niche, threaded fitting, front body. Jet not included.

Flow rate 5 m³/h at 1 bar.

Code	Standard Pack	Standard weight in kg	Standard volume in m ³
20295	4	4	0.018

Chrome accessories only suitable for tubs that do not use any chemical treatment.
Not suitable for pools.

Pool Jet accessories are designed for pools that have a hydromassage section.



Pool Jet 1 Directional Jet

DESCRIPTION

Flow rate 2.4 to 3.6 m³/h. Accessories compatible with 2½" handrail for Pool Jet.

	Code	Standard Pack	Standard weight in kg	Standard volume in m ³
Stainless steel finish*	63148	25	3.83	0.028
White finish	63149	25	3.83	0.028

Pool Jet 1 Rotating Jet

DESCRIPTION

Flow rate 2.4 to 3.6 m³/h. Accessories compatible with 2½" handrail for Pool Jet.

	Code	Standard Pack	Standard weight in kg	Standard volume in m ³
Stainless steel finish*	63150	25	3.83	0.028
White finish	63151	25	3.83	0.028

Pool Jet 2 Rotating Jets

DESCRIPTION

Flow rate 2.4 to 3.6 m³/h. Accessories compatible with 2½" handrail for Pool Jet.

	Code	Standard Pack	Standard weight in kg	Standard volume in m ³
Stainless steel finish*	63152	25	3.83	0.028
White finish	63153	25	3.83	0.028

Pool Jet Rotating Beehive

DESCRIPTION

Flow rate 2.4 to 3.6 m³/h. Accessories compatible with 2½" handrail for Pool Jet.

	Code	Standard Pack	Standard weight in kg	Standard volume in m ³
Stainless steel finish*	63154	25	3.83	0.028
White finish	63155	25	3.83	0.028

Wall conduit for Pool Jet

DESCRIPTION

Made up of: The jet Straight body (20 mm Air x 32 mm Water), 20 cm wall conduit, niche, front body. Jet not included.

	Code	Standard Pack	Standard weight in kg	Standard volume in m ³
	63146	4	4	0.018

Chrome accessories only suitable for tubs that do not use any chemical treatment.
Not suitable for pools.

1 1/2" main drain

ASTRALPOOL 

DESCRIPTION

With elbow for gluing Ø 50 mm pipe.

	Code	Standard Pack	Standard weight in kg	Standard volume in m ³
Chrome-plated bronze front panel	04104	3	7.5	0.028

Adjustable air inlet

ASTRALPOOL 

DESCRIPTION

3/4" to control air massage to Venturi system for jet function.

	Code	Standard Pack	Standard weight in kg	Standard volume in m ³
Chrome-plated bronze front panel	04108	10	9.0	0.028
White plastic front panel	04110	10	3.0	0.028

Pneumatic push button

ASTRALPOOL 

DESCRIPTION

For starting and stopping massage and hydromassage functions.

	Code	Standard Pack	Standard weight in kg	Standard volume in m ³
Chrome-plated bronze front panel	04111	10	6.0	0.028
White plastic front panel	04113	12	6.0	0.028

Blower Inlet

ASTRALPOOL 

DESCRIPTION

For minispa air distribution from the blower. 1 1/2" thread.

	Code	Standard Pack	Standard weight in kg	Standard volume in m ³
Chrome-plated bronze front panel	04114	20	7.5	0.028

Chrome accessories only suitable for tubs that do not use any chemical treatment.
Not suitable for pools.



1 1/4" jet with adaptor to water return

DESCRIPTION

Jet with adaptor to return water to pipe. Also adaptor to connect to water return and air circulation pipe, solvent for inner Ø 32 mm, directional.

	Code	Standard Pack	Standard weight in kg	Standard volume in m ³
Chrome-plated bronze front panel	04095	8	12.0	0.028
White plastic front panel	04097	12	12.0	0.028



1 1/4" jet

DESCRIPTION

With adaptor to connect to return water pipe and Venturi system to glue to Ø 32 mm pipe, directional.

	Code	Standard Pack	Standard weight in kg	Standard volume in m ³
Chrome-plated bronze front panel	04092	8	10.0	0.028
White plastic front panel	04094	24	5.0	0.028



1 1/4" return inlet

	Code	Standard Pack	Standard weight in kg	Standard volume in m ³
Built in chrome brass	04100	4	15.0	0.028
Built in white plastic	04103	12	3.5	0.028



Programmable digital thermostat



DESCRIPTION

To operate ON/OFF contactor.

Code	Standard Pack	Standard weight in kg	Standard volume in m ³
11288	20	0.5	0.003



Electric press button



DESCRIPTION

230 V 50 Hz.

Code	Standard Pack	Standard weight in kg	Standard volume in m ³
74467	1	1.5	0.003



Electropneumatic equipment



DESCRIPTION

With two switches. Up to 1.47 kW (2HP).

Code	Standard Pack	Standard weight in kg	Standard volume in m ³
04053	2	4.0	0.028

Pneumatic switch



DESCRIPTION

For starting and stopping massage and hydromassage functions.



Code	Standard Pack	Standard weight in kg	Standard volume in m ³	
Pneumatic switch	04050	25	1.0	0.028
Pneumatic switch and presostat	11290	6	0.5	0.028
Pneumatic presostat	11291	12	1.0	0.028

Continuous operation

lateral turbo blower pump



DESCRIPTION

Air pump designed for spas, hydromassage tubs and similar which produces a constant stream of air bubbles at medium and high air volume levels. It can also be used to stir up the filter bed, for example in backwash cycles where a low intensity air current is required. The filter casing and impeller are made from an injected aluminium alloy whilst the motor spindle is manufactured from stainless steel, with the impeller dynamically balanced and directly adapted to the spindle. The motors, 2 single phase or 3 phase for continuous use, are made from steel in compliance with CEI 2/3 1988 regulations, and feature IP54 external protection and class-F insulation. The pumps can be mounted horizontally or vertically. Moreover, since there is no contact between the mobile parts and the pump static discharges, neither lubrication nor maintenance is necessary and it also doesn't cause wear on the parts.

The turbines have a maximum working temperature of 40°C. Do not use in conjunction with aggressive, inflammable or explosive gases.

Model	Code	Frequency (Hz)	Power supply (V)	Phase	Flow rate (m ³ /h)	Maximum pressure (mbar)	Standard weight (kg)	Standard volume (m ³)
Blower 0.4 kW	33970	50	Δ 200-240 Y 345-415	3	80	130	10	0.045
Blower 0.5 kW		60	Δ 220-275 Y 380-480	3	98	170		
Blower 0.85 kW	35388	50	200-240	1	145	160	17	0.059
Blower 0.95 kW		60	200-240	1	175	160		
Blower 0.85 kW	35387	50	Δ 200-240 Y 345-415	3	145	160	16	0.045
Blower 0.95 kW		60	Δ 220-275 Y 380-480	3	175	160		
Blower 1.3 kW	31090	50	200-240	1	210	170	23	0.059
Blower 1.5 kW		60	200-240	1	255	140		
Blower 1.3 kW	31091	50	Δ 200-240 Y 345-415	3	210	170	22	0.059
Blower 1.5 kW		60	Δ 220-275 Y 380-480	3	255	140		
Blower 1.5 kW	33971	50	200-240	1	210	220	24	0.064
Blower 1.75 kW		60	200-240	1	255	220		
Blower 1.6 kW	31092	50	Δ 200-240 Y 345-415	3	210	220	23	0.064
Blower 2.1 kW		60	Δ 220-275 Y 380-480	3	255	220		
Blower 1.6 kW 2V	35389	50	Δ 200-240 Y 345-415	3	150	300	25	0.087
Blower 2.06 kW 2V		60	Δ 220-275 Y 380-480	3	180	310		
Blower 2.2 kW	31093	50	Δ 200-240 Y 345-415	3	318	230	30	0.097
Blower 2.55 kW		60	Δ 220-275 Y 380-480	3	376	220		
Blower 3.0 kW 2V	31094	50	Δ 200-240 Y 345-415	3	230	410	40	0.126
Blower 3.45 kW 2V		60	Δ 220-275 Y 380-480	3	275	400		
Blower 3.0 kW	31095	50	Δ 200-240 Y 345-415	3	318	280	36	0.097
Blower 3.45 kW		60	Δ 220-275 Y 380-480	3	376	280		
Blower 4.3 kW 2V	31096	50	Δ 345-415 Y 600-720	3	520	600	54	0.217
Blower 4.8 kW 2V		60	Δ 380-480 Y 660-720	3	385	320		
Blower 5.5 kW	31097	50	Δ 345-415 Y 600-720	3	530	320	63	0.16
Blower 6.3 kW		60	Δ 380-480 Y 660-720	3	620	340		
Blower 5.5 kW 2V	33972	50	Δ 345-415 Y 600-720	3	320	515	66	0.201
Blower 6.3 kW 2V		60	Δ 380-480 Y 660-720	3	385	530		
Blower 7.5 kW	31098	50	Δ 345-415 Y 600-720	3	530	400	66	0.16
Blower 8.6 kW		60	Δ 380-480 Y 660-720	3	620	400		
Blower 11 kW 2V	33973	50	Δ 345-415 Y 600-720	3	520	600	104	0.353
Blower 12.6 kW 2V		60	Δ 380-480 Y 660-720	3	620	600		
Blower 12.5 kW	33974	50	Δ 345-415 Y 600-720	3	1050	270	116	0.353
Blower 14.5 kW		60	Δ 380-480 Y 660-720	3	1250	260		

Intermittent operation

air blower, 900 W



	Code	Standard Pack	Standard weight in kg	Standard volume in m ³
0.90 kW flow 54 m ³ /h at 1.5 m water head	19289	1	3.5	0.028

Water pump



DESCRIPTION

ABS (25%) and fibreglass (75%) housing. A 0.37 kW (0.5 hp) motor. IP-55 electrical connection rating of 24 V 220 V 1~ 50Hz . 2" male suction connection. 1 1/2" male return connection.

	Code	Standard Pack	Standard weight in kg	Standard volume in m ³
Water pump	04091	1	6.0	0.016

TECHNICAL FEATURES

Water head	m ³ /h
2	16.5
4	14.8
6	12.6
8	10
10	7

Intermittent operation

air blower



	Code	Standard Pack	Standard weight in kg	Standard volume in m ³
At 1 m water head				
0.74 kW, Flow 65 m ³ /h	06862	1	3.5	0.028
1.10 kW, Flow 133 m ³ /h	06863	1	3.5	0.028

Cala Pump



DESCRIPTION

Centrifugal pump for spas, backwashes and other applications.

- Pump body manufactured in polypropylene reinforced with fibreglass, resistant to pool chemical products thus guaranteeing long and excellent duration.
- Turbine in Noryl.
- Graphite and ceramic mechanical seal.
- AISI 316L stainless steel motor spindle.
- Enclosed motor, completely silent, with IP-55 protection at 2850 r.p.m. Single phase power voltage at 230V-50Hz or triphase at 230/400-50Hz.
- Versions from 1.5 to 4.5 HP.
- Suction and return connections for gluing hoses included with the pump.
- Suction and return at Ø63.

	Code	Standard Pack	Standard weight in kg	Standard volume in m ³
Single phase 1.1 kW Cala Pump	CA150M	1	15.0	0.058
Tri phase 1.1 kW Cala Pump	CA150T	1	15.0	0.058
Single phase 1.5 kW Cala Pump	CA200M	1	16.5	0.058
Tri phase 1.5 kW Cala Pump	CA200T	1	16.5	0.058
Single phase 2.2 kW Cala Pump	CA300M	1	19.5	0.058
Tri phase 2.2 kW Cala Pump	CA300T	1	19.5	0.058
Single phase 2.9 kW Cala Pump	CA400M	1	22.5	0.058
Tri phase 3.3 kW Cala Pump	CA450T	1	22.5	0.058

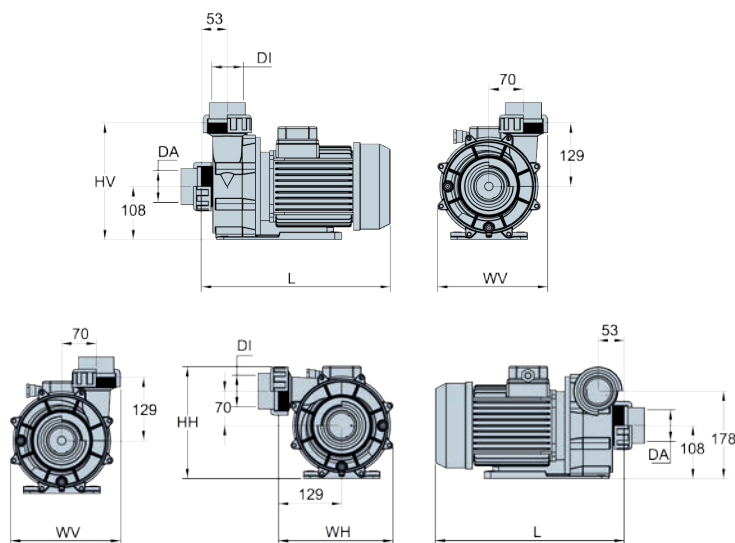

TECHNICAL FEATURES

Code	Power		Size						
	kW	HP	L	WV	HV	WH	HH	DA	DI
CA150M	1.1	1.5	350	225	237	235	228	Ø63	Ø63
CA150T									
CA200M	1.5	2.0	365	225	237	235	228	Ø63	Ø63
CA200T									
CA300M	2.2	3.0	385	225	237	235	228	Ø63	Ø63
CA300T									
CA400M	2.9	4.0	415	225	237	235	228	Ø63	Ø63
CA450T									

Essentia sauna



The Essentia sauna can be made to order in the following Woods:

- Standard wood: Thermo Magnolia.
(optional: Thermo Aspen).

- Bench wood: Thermo Magnolia
(optional: Thermo Aspen).

DESCRIPTION

Essentia sauna reflects precise lines, creativity and care of details and exclusive natural woods. It merges perfectly the nordic tradition with the Italian design and accurate balanced proportions. This sauna provides perfect finishing that makes it suitable to fit into luxury wellness areas. This sauna have:

- Wall panels of Thermo Magnolia wood 15 x 170 mm.
- Benches of thermos Magnolia wood 28 mm.
- Exclusive Harvia heater with touch control panel.
- Secured transparent glass 8 mm.
- Monomaterial surfaces.
- LED White/RGB.

Dimensions (mm)	Code	Standard Pack	Standard weight in kg	Standard volume in m ³
Spas				
200 x 200 x 239	72892	-	-	-
250 x 200 x 239	72893	-	-	-
250 x 250 x 239	72894	-	-	-
300 x 250 x 239	72895	-	-	-
Accessories				
Stainless Steel accessories set	70443	un.	-	-
RGB Led lighting kit with remote control	70445	un.	-	-
Outside Wall finished with vertical timber panels	70447	Lin. m	-	-
Window bronze/transparent	70449	Sq. m	-	-
Aroma dosing system	70453	un.	-	-

TECHNICAL FEATURES

Code	Type	Dimensions (cm)	Heating (kW)	Control unit
72892	Essentia sauna	200 x 200 x 239	7 kW 230/400V 3~	Touchscreen / Exterior
72893	Essentia sauna	250 x 200 x 239	7 kW 230/400V 3~	Touchscreen / Exterior
72894	Essentia sauna	250 x 250 x 239	10.8 kW 230/400V 3~	Touchscreen / Exterior
72895	Essentia sauna	300 x 250 x 239	10.8 kW 230/400V 3~	Touchscreen / Exterior

SAUNAS

Sanama sauna /

Sanama Salt Room*



Salt generator mounted in separated room

The Innsbruck sauna can be made to order in the following woods:

- Standard wood: Red Cedar
- Optional: Nordic spruce / White pine / Thermo Aspen-Alder-Pine
- Bench wood: Abichi

DESCRIPTION

Sanama shows an exciting design that merges natural wood with salt elements from Himalaya. Its perfect finishes and excellent details become this sauna an essential high quality element that cannot be missed in a wellness area.

Sanama contains:

- Benches and back rests made of Abachi.
- Heater with touch screen control panel (*halogenerator as an option)
- S.S. bowl for salt elements.

Dimensions (mm)	Code	Standard Pack	Standard weight in kg	Standard volume in m ³
Spas				
150 x 150 x 210	65400S	-	-	-
150 x 218 x 210	65401S	-	-	-
218 x 218 x 210	65402S	-	-	-
286 x 318 x 210	65403S	-	-	-
Accessories				
Salt decorative elements set	70444	un.	-	-
Outside Wall finished with vertical timber panels	70447	Lin.m	-	-
RGB Chromo therapy kit with remote control	70457	un.	-	-

* OPTIONAL: Halogenerator (instead of heater)

TECHNICAL FEATURES

Code	Type	Dimensions (cm)	Light	Control unit	Heating (kw)
65400S	Sanama	150 x 150 x 210	Led White / RGB	Touchscreen / Exterior	4.5 kW 230/400V 3~
65401S	Sanama	150 x 218 x 210	Led White / RGB	Touchscreen / Exterior	6 kW 230/400V 3~
65402S	Sanama	218 x 218 x 210	Led White / RGB	Touchscreen / Exterior	8 kW 230/400V 3~
65403S	Sanama	286 x 318 x 210	Led White / RGB	Touchscreen / Exterior	9 kW 230/400V 3~

Bella sauna

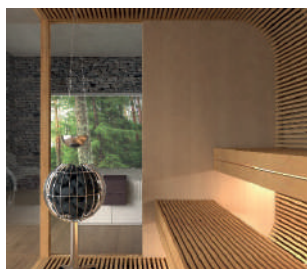

DESCRIPTION

- Hemlock playwood panels 14 mm.
- Curved decorative elements of Thermo Aspen 21 mm.
- Benches of thermos Aspen 21 mm.
- Secured transparent glass 8 mm.
- Harvia design sauna heater.
- Outdoor touch control panel.
- Aromatherapy/Salt Metal Bowl.
- Led light warm white 3000 K.
- Option for glass ceiling.

Dimensions (mm)	Code	Standard Pack	Standard weight in kg	Standard volume in m ³
Spas				
180 x 180 x 210	72916	-	-	-
230 x 180 x 210	72917	-	-	-
230 x 230 x 210	72918	-	-	-
280 x 230 x 210	72919	-	-	-
Accessories				
Stainless steel accessories set	70443	un.	-	-
RGB Led lighting kit with remote control	70445	un.	-	-
Outside wall finished with vertical playwood panels	To consult	lin.m	-	-
Glass roof panel	To consult	sq.m	-	-
Heater safety railing	To consult	un.	-	-

The Bella sauna can be made to order in the following woods:

- Standard wood: Hemlock Playwood
- Bench wood: Thermo Aspen

TECHNICAL FEATURES

Code	Type	Dimensions (cm)	Light	Control unit	Heating (kw)
72916	Bella sauna	180 x 180 x 210	Led White / RGB	Touchscreen Exterior	6.9 kW 230 / 400 3~
72917	Bella sauna	230 x 180 x 210	Led White / RGB	Touchscreen Exterior	6.9 kW 230 / 400 3~
72918	Bella sauna	230 x 230 x 210	Led White / RGB	Touchscreen Exterior	10.5 kW 230 / 400 3~
72919	Bella sauna	280 x 230 x 210	Led White / RGB	Touchscreen Exterior	10.5 kW 230 / 400 3~

Lobos sauna

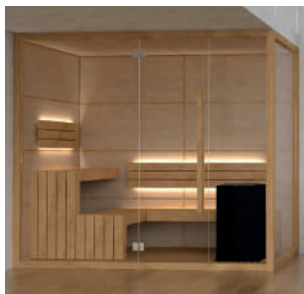

DESCRIPTION

- Hemlock playwood panels 14 mm.
- Benches of Abachi 21 mm.
- Secured transparent glass 8 mm.
- Exclusive Harvia sauna heater.
- Outdoor touch control panel.
- Led light Warm White 3000 K.

The Lobos sauna can be made to order in the following woods:

- Standard wood: Hemlock Playwood
- Bench wood: Abichi

Dimensions (mm)	Code	Standard Pack	Standard weight in kg	Standard volume in m ³
Spas				
134 x 254 x 210	72913	-	-	-
194 x 195 x 210	72914	-	-	-
254 x 254 x 210	72915	-	-	-
Accessories				
Stainless steel accessories set	70443	un.	-	-
Salt decorative elements set	70444	un.	-	-
Remote control kit for RGB LED colours	70445	un.	-	-
Outside wall finished with vertical timber panels	70447	lin.m	-	-
Roof extension	70448	sq.m	-	-
Tintes/transparent glass window	70449	sq.m	-	-

TECHNICAL FEATURES

Code	Type	Dimensions (cm)	Light	Control unit	Heating (kw)
72913	Lobos sauna	134 x 254 x 210	Led White / RGB	Touchscreen Exterior	6 kW 230 / 400 3~
72914	Lobos sauna	194 x 195 x 210	Led White / RGB	Touchscreen Exterior	8 kW 230 / 400 3~
72915	Lobos sauna	254 x 254 x 210	Led White / RGB	Touchscreen Exterior	9 kW 230 / 400 3~



FEEL THE PLEASURE OF BEAUTIFUL DESIGNS

Our goal is to take care for people's health and wellbeing. Therefore, our main objective in the wellness sector is to provide global value-add solutions that guarantee the well-being, health and comfort of users, regardless of the type of facility, its location or purpose.

In AstralPool we are artisans of wood. We adapt our designs to the project needs taking care of all kinds of details with the aim of achieving a high quality product.

Our planet is changing and it's changing fast. Manufacturing Saunas we want to protect the world's resources. We guarantee that all wood we use in our products grows back again.



Asana steam bath cabin

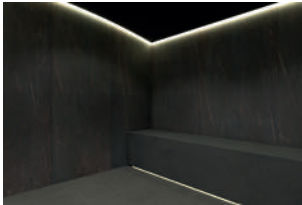

Lighting:

Spots : 12V White LED

Under bench: 12V RGB LED

Ceiling: 12V RGB LED

Connection:

400 V III + Neutral + Grounding

230 V III + Grounding

230 V I + Neutral (9 Kw max.)

DESCRIPTION

Straight lines, sober and elegant design. AstralPool steam cabins offer the luxury of Italian design adapted to the most advanced technology in the market.

- Wall modules: Manufactured with double high density expanded polystyrene panel on an anodized aluminum structure.
- Ceiling: Vaulted ceiling made in black methacrylate modules of 3 mm, standing on anodized aluminium support, and tightenup with multicoated layers of polyester resin.
- Ceiling & underbench perimetral LED included.
- Diffuser in black lacquered.
- Lower and upper ring: Anodized aluminum.
- Handle: Tubular stainless steel matt black.
- Frontal finishing: laminated glass (5+5) of 10 mm.
- Benches coated with large format porcelain in slate black Sirius (Group 1).
- Walls coated with large format porcelain in marble black Kelya (Group 2).
- 2 puffs are included.
- Door: Made of tempered glass of 8 mm, hinges of anodized aluminium. Width 90 cm*.
- Control panel: Ecotouch
- Steam group included: Power according to model (optional: softener).
- Aromatherapy one essence included (optional up to 4 essences).

*Can vary according to customised design.

Dimensions (mm)	Code	Standard Pack	Standard weight in kg	Standard volume in m ³
Steam bath cabin				
200 x 200 x 220	73908	-	-	-
250 x 200 x 220	73909	-	-	-
250 x 250 x 220	73910	-	-	-
300 x 250 x 220	73911	-	-	-
300 x 300 x 220	73912	-	-	-

TECHNICAL FEATURES

Code	Type	Dimensions (cm)	Heating (kW)	Control unit
73908	Asana steam bath cabin	200 x 200 x 220	9 kW	Ecotouch
73909	Asana steam bath cabin	250 x 200 x 220	9 kW	Ecotouch
73910	Asana steam bath cabin	250 x 250 x 220	12 kW	Ecotouch
73911	Asana steam bath cabin	300 x 250 x 220	12 kW	Ecotouch
73912	Asana steam bath cabin	300 x 300 x 220	12 kW	Ecotouch

Bandha steam bath cabin

Lighting:
Spots : 12V White LED
Under bench: 12V RGB LED
Ceiling: 12V RGB LED
Connection:
400 V III + Neutral + Grounding
230 V III + Grounding
230 V I + Neutral (9 Kw max.)
DESCRIPTION

Straight lines, sober and elegant design. AstralPool steam cabins offer the luxury of Italian design adapted to the most advanced technology in the market.

- Wall modules: Manufactured with double high density expanded polystyrene panel on an anodized aluminum structure.
- Ceiling: Vaulted ceiling made in white methacrylate modules of 3 mm, standing on anodized aluminium support, and tightens up with multicoated layers of polyester resin.
- Ceiling & underbench perimetral LED included.
- Diffuser in Stainless Steel.
- Lower and upper ring: Anodized aluminum.
- Handle: Tubular stainless steel.
- Frontal finishing: laminated glass (5+5) of 10 mm.
- Benches coated with large format porcelain in sand color Gada (Group 0).
- Walls coated with large format porcelain in sand color Gada (Group 0).
- 2 puffs are included.
- Sink in porcelanic gada sand color is included.
- Door: Made of tempered glass of 8 mm, hinges of anodized aluminium. Width 90 cm*.
- Control panel: Ecotouch
- Steam group included: Power according to model (optional: softener).
- Aromatherapy one essence included (optional up to 4 essences).

*Can vary according to customised design.

Dimensions (mm)	Code	Standard Pack	Standard weight in kg	Standard volume in m ³
Steam bath cabin				
250 x 200 x 220	73921	-	-	-
250 x 250 x 220	73922	-	-	-
300 x 250 x 220	73923	-	-	-
300 x 300 x 220	73924	-	-	-

TECHNICAL FEATURES

Code	Type	Dimensions (cm)	Heating (kW)	Control unit
73921	Bandha steam bath cabin	250 x 200 x 220	9 kW	Ecotouch
73922	Bandha steam bath cabin	250 x 250 x 220	12 kW	Ecotouch
73923	Bandha steam bath cabin	300 x 250 x 220	12 kW	Ecotouch
73924	Bandha steam bath cabin	300 x 300 x 220	12 kW	Ecotouch

Cala steam bath cabin



Lighting:

Spots : 12V White LED
Under bench: 12V RGB LED

Connection:

400 V III + Neutral + Grounding
230 V III + Grounding
230 V I + Neutral (9 Kw max.)

DESCRIPTION

Straight lines, sober and elegant design. AstralPool steam cabins offer the luxury of Italian design adapted to the most advanced technology in the market.

- Wall modules: Manufactured with double high density expanded polystyrene panel on an anodized aluminum structure.
- Ceiling: Vaulted ceiling made in black methacrylate modules of 3 mm, standing on anodized aluminium support, and tightenup with multicoated layers of polyester resin.
- Starry sky & underbench perimetral LED included.
- Diffuser in stainless steel
- Lower and upper ring: Anodized aluminum.
- Handle: Tubular stainless steel
- Frontal finishing: laminated glass (5+5) of 10 mm.
- Benches coated with large format porcelain in stone grey Kreta (Group 2).
- Walls coated with large format porcelain in stone grey Kreta (Group 2), black Sirius (Group 1).
- Sink in sand color is included.
- Door: Made of tempered glass of 8 mm, hinges of anodized aluminium. Width 90 cm*.
- Control panel: Ecotouch.
- Starry Sky is included in this model.
- Steam group included: Power according to model (optional: softener).
- Aromatherapy one essence included (optional up to 4 essences).

*Can vary according to customised design.

Dimensions (mm)	Code	Standard Pack	Standard weight in kg	Standard volume in m ³
Steam bath cabin				
250 x 200 x 220	73913	-	-	-
250 x 250 x 220	73914	-	-	-
300 x 250 x 220	73915	-	-	-
300 x 300 x 220	73916	-	-	-

TECHNICAL FEATURES

Code	Type	Dimensions (cm)	Heating (kW)	Control unit
73913	Cala steam bath cabin	250 x 200 x 220	9 kW	Ecotouch
73914	Cala steam bath cabin	250 x 250 x 220	12 kW	Ecotouch
73915	Cala steam bath cabin	300 x 250 x 220	12 kW	Ecotouch
73916	Cala steam bath cabin	300 x 300 x 220	12 kW	Ecotouch

Hara steam bath cabin

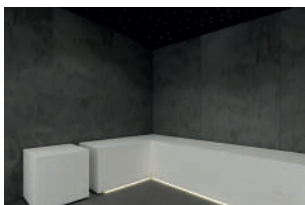

Lighting:
Spots : 12V White LED
Under bench: 12V RGB LED

Connection:
400 V III + Neutral + Grounding
230 V III + Grounding
230 V I + Neutral (9 Kw max.)

DESCRIPTION

Straight lines, sober and elegant design. AstralPool steam cabins offer the luxury of Italian design adapted to the most advanced technology in the market.

- Wall modules: Manufactured with double high density expanded polystyrene panel on an anodized aluminum structure.
- Ceiling: Vaulted ceiling made in black methacrylate modules of 3 mm, standing on anodized aluminium support, and tightentup with multicoated layers of polyester resin.
- Starry Sky & underbench perimetral LED included.
- Diffuser in black lacquered.
- Lower and upper ring: Anodized aluminum.
- Handle: Tubular stainless steel matt black.
- Frontal finishing: laminated glass (5+5) of 10 mm.
- Frontal finishing Benches coated with large format porcelain in Nilium (Group 2).
- Walls coated with large format porcelain in Radium (Group 2).
- 1 Puff is included.
- Door: Made of tempered glass of 8 mm, hinges of anodized aluminium black matte.
- Control panel: Ecotouch.
- Starry Sky is included in this model.
- Steam group included: Power according to model (optional: softener).
- Aromatherapy one essence included (optional up to 4 essences).

*Can vary according to customised design.

Dimensions (mm)	Code	Standard Pack	Standard weight in kg	Standard volume in m ³
Steam bath cabin				
250 x 250 x 220	73925	-	-	-
300 x 250 x 220	73926	-	-	-
300 x 300 x 220	73927	-	-	-

TECHNICAL FEATURES

Code	Type	Dimensions (cm)	Heating (kW)	Control unit
73925	Hara steam bath cabin	250 x 250 x 220	12 kW	Ecotouch
73926	Hara steam bath cabin	300 x 250 x 220	12 kW	Ecotouch
73927	Hara steam bath cabin	300 x 300 x 220	12 kW	Ecotouch



Sutra steam bath cabin



Lighting:

Spots : 12V White LED

Under bench: 12V RGB LED

LED

Ceiling: 12V RGB LED

Connection:

400 V III + Neutral + Grounding

230 V III + Grounding

230 V I + Neutral (9 Kw max.)

DESCRIPTION

Straight lines, sober and elegant design. AstralPool steam cabins offer the luxury of Italian design adapted to the most advanced technology in the market.

- Wall modules: Manufactured with double high density expanded polystyrene panel on an anodized aluminum structure.
- Ceiling: Vaulted ceiling made in white methacrylate modules of 3 mm, standing on anodized aluminium support, and tightenup with multicoated layers of polyester resin.
- Ceiling & underbench perimetral LED included.
- Diffuser in black lacquered.
- Lower and upper ring: Anodized aluminum.
- Handle: Tubular stainless steel matt black.
- Frontal finishing: laminated glass (5+5) of 10 mm.
- Benches coated with large format porcelain in Kairos (Group 3).
- Walls coated with white solid surface.
- Door: Made of tempered glass of 8 mm, hinges of anodized aluminium. Width 90 cm*.
- Control panel: Ecotouch
- Steam group included: Power according to model (optional: softener).
- Aromatherapy one essence included (optional up to 4 essences).

*Can vary according to customised design.

Dimensions (mm)	Code	Standard Pack	Standard weight in kg	Standard volume in m³
Steam bath cabin				
250 x 200 x 220	73917	-	-	-
250 x 250 x 220	73918	-	-	-
300 x 250 x 220	73919	-	-	-
300 x 300 x 220	73920	-	-	-

TECHNICAL FEATURES

Code	Type	Dimensions (cm)	Heating (kW)	Control unit
73917	Sutra steam bath cabin	250 x 200 x 220	9 kW	Ecotouch
73918	Sutra steam bath cabin	250 x 250 x 220	12 kW	Ecotouch
73919	Sutra steam bath cabin	300 x 250 x 220	12 kW	Ecotouch
73920	Sutra steam bath cabin	300 x 300 x 220	12 kW	Ecotouch









FROM THE CONCEPT TO REALITY

In Fluidra we are aware about every project is unique and every place an experience. For that reason, we want to make it easy for you, manufacturing your ideal steam bath under your project needs.





A complete bespoke solution for the most demanding projects.





Types of jets

	<p>RAIN</p> <p>Delicate on the skin, the rain jet tickles it causing a pleasant, stimulating and relaxing sensation.</p>		<p>NEBULIZED</p> <p>The nebulized jet slips in the environment, wrapping the body in a cosy and regenerating cloud of water.</p>		<p>TROPICAL</p> <p>A constant and powerful jet, with an embracing and revitalizing effect, massaging the body and recharging its energy.</p>
	<p>WATERFALL</p> <p>The powerful gesture of the waterfall absorbs us and, through the skin contact, communicates its energizing force to the whole body.</p>		<p>AERATED</p> <p>Water and air mix and enhance each other, massaging the body and inducing creativity and dynamism.</p>		<p>ATOMIZED</p> <p>By reducing the water into tiny particles, the atomized jet gives a refreshing and relaxing feeling of wellbeing.</p>
	<p>TROPICAL AERATED</p> <p>The mix between tropical and aerated jets creates the effect of a dense rain which, descending, relieves and reduces muscular tension.</p>		<p>LED + NEBULIZED</p> <p>A mixture of different therapies and effects, the LED light optimizes and enriches the regenerating effects of nebulization.</p>		<p>LED + ATOMIZED</p> <p>The fusion of water particles and LED light heat enhances and intensifies the delicate touch of the atomized jet.</p>









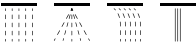
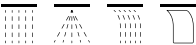

Accessories

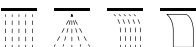
			
Audio	Water aromatherapy	Air aromatherapy	Additional external thermostatic

Controls

		
<p>MANUAL</p> <p>Control (on/off) each shower jets through the keypad (as many buttons as types of jets).</p>	<p>SEQUENCE</p> <p>Activate the pre-programmed sequence of the different shower jets pressing only one button.</p>	<p>MULTI SEQUENCE (SENSE PRO MODEL ONLY)</p> <p>Activate the programmed sequence you want depending on your needs. Scheduled sequences: RELAX / BALANCE / SPORT / ENERGY</p>

Summary table

Code	Description	Lighting	Jets	Dimensions (cm)	Control	Accessories
AF-FL001	Sense Pro	RGB		70 x 70	4 Pre-set programs (Relax, Sport, Balance, Energy) (MULTISEQUENCE)	-
AF-FL002	Aqua Sequence	RGB		70 x 70	1 button to start the water sequence (SEQUENCE)	
AF-FL003	Aqua Sequence White	WHITE				
AF-FL004	Aqua Sequence Nude	-				
AF-FL005	Aqua	RGB		70 x 70	4 buttons. 1 to start each water effect. (MANUAL)	
AF-FL006	Aqua White	WHITE				
AF-FL007	Aqua Nude	-				
AF-FL008	Infinity Sequence	RGB		42 x 42	1 button to start the water sequence (SEQUENCE)	
AF-FL009	Infinity Sequence White	WHITE				
AF-FL010	Infinity Sequence Nude	-				
AF-FL011	Infinity	RGB		42 x 42	3 buttons. 1 to start each water effect. (MANUAL)	
AF-FL012	Infinity White	WHITE				
AF-FL013	Infinity Nude	-				
AF-FL014	Vita	RGB		Ø 50	2 buttons. 1 to start each water effect. (SEQUENCE)	
AF-FL015	Vita White	WHITE				
AF-FL016	Vita Nude	-				

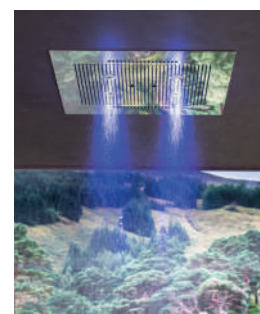

Sense Pro shower

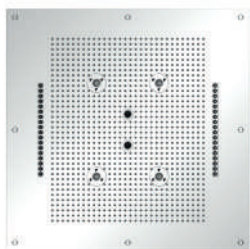

DESCRIPTION

RGB Lighting

Jets



Control panel & Sequences

relax | energy | balance | sport



	Code	Standard Pack	Standard weight in kg	Standard volume in m ³
Sense Pro shower	AF-FL001	1	-	-

Aqua shower

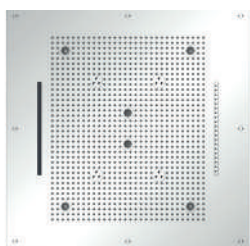

Aqua

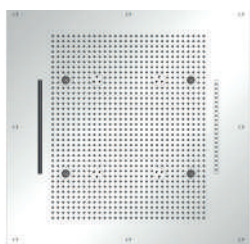

Aqua White

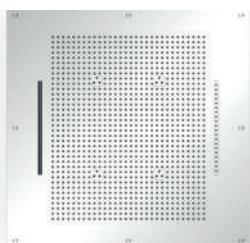

Aqua Nude

DESCRIPTION

Aqua: RGB Lighting - Aqua Nude: Without lighting - Aqua White: White lighting

Jets

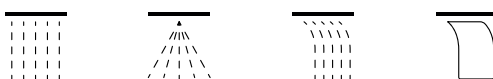

Control panel & Sequences

Manual



Sequence



	Code	Standard Pack	Standard weight in kg	Standard volume in m ³
Aqua Sequence shower	AF-FL002	1	.	.
Aqua Sequence White shower	AF-FL003	1	.	.
Aqua Sequence Nude shower	AF-FL004	1	.	.
Aqua shower	AF-FL005	1	.	.
Aqua White shower	AF-FL006	1	.	.
Aqua Nude shower	AF-FL007	1	.	.

Infinity shower

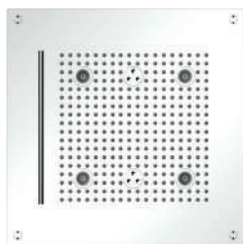

Infinity

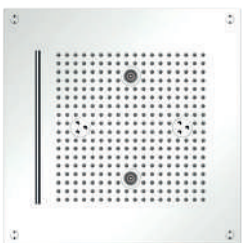

Infinity White

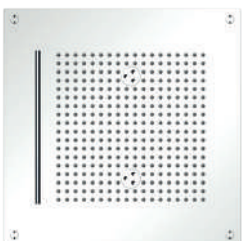

Infinity Nude

DESCRIPTION

Infinity: RGB Lighting - Infinity Nude: Without lighting - Infinity White: White lighting
Jets



Control panel & Sequences

Manual



Sequence



	Code	Standard Pack	Standard weight in kg	Standard volume in m ³
Infinity Sequence shower	AF-FL008	1	-	-
Infinity Sequence White shower	AF-FL009	1	-	-
Infinity Sequence Nude shower	AF-FL010	1	-	-
Infinity shower	AF-FL011	1	-	-
Infinity White shower	AF-FL012	1	-	-
Infinity Nude shower	AF-FL013	1	-	-

Vita shower

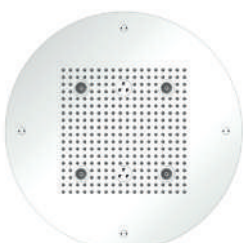

Vita

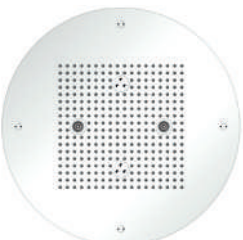

Vita White

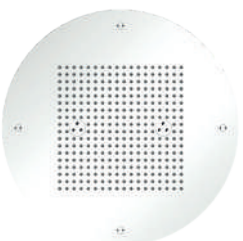

Vita Nude

DESCRIPTION

Vita: RGB Lighting - Vita Nude: Without lighting - Vita White: White lighting
Jets

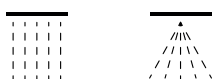

Control panel & Sequences

Manual



	Code	Standard Pack	Standard weight in kg	Standard volume in m ³
Vita shower	AF-FL014	1	-	-
Vita White shower	AF-FL015	1	-	-
Vita Nude shower	AF-FL016	1	-	-

Wooden nordic bath



DESCRIPTION

The baths are made with the best quality of Red Cedar (grade 2.40 mm thick) for maximum durability. They are available in different diameters from 150 cm to 220 cm to accommodate 2 to 8 people.

	Code	Standard Pack	Standard weight in kg	Standard volume in m ³
Wooden nordic bath				
150 cm - 2/3 people	74095	1	-	-
160 cm - 3/4 people	74096	1	-	-
180 cm - 5/6 people	74109	1	-	-
200 cm - 6/7 people	74110	1	-	-
220 cm - 7/8 people	74111	1	-	-

Stainless steel nordic bath



DESCRIPTION

The baths are made with the best quality of Red Cedar (grade 2.40 mm thick) and stainless steel for maximum durability. They are available in different diameters from 150 cm to 220 cm to accommodate 2 to 8 people.

	Code	Standard Pack	Standard weight in kg	Standard volume in m ³
Stainless Steel nordic bath				
150 cm - 2/3 people	74112	1	-	-
160 cm - 3/4 people	74113	1	-	-
180 cm - 5/6 people	74114	1	-	-
200 cm - 6/7 people	74115	1	-	-
220 cm - 7/8 people	74116	1	-	-

Stainless steel bath



DESCRIPTION

AstralPool Nordic bath offers a unique filtration and treatment technology for Nordic baths to guarantee bacteria-free water.

- Ultra fine 1 micron filtration captures 100% of particles.
- The 18 m³/h pump have a 6 minutes turnover.
- High radiation UV and Ozone treatments kill bacteria and disinfect the water.
- OZONE CHOC® treatment cleans biofilms and eliminates bacteria (international patent EP2785648).
- The measurement and management of water quality are managed by an integrated computer (ORP reader, pH, T° C).

	Code	Standard Pack	Standard weight in kg	Standard volume in m ³
Water treatment nordic bath				
Standard	74117	1	-	-
PRO	74118	1	-	-
PRO+	74119	1	-	-

TECHNICAL FEATURES

Code	Description	Pump	Ozone generator	UV	Heater	PH/ORP gestion	Smartphone APP
74117	Water treatment nordic bath Standard	550 w	1 lamp	1 lamp	3 kw	-	-
74118	Water treatment nordic bath PRO	550 w	2 lamps	1 lamp	3 kw	Yes	-
74119	Water treatment nordic bath PRO+	750 w with integrated heater 1.5 wh	3 lamps	1 lamp	3 kw + 3 kw	Yes	Yes



MOODIFY

Moodify is the first emotional manager in the market capable of adapting to the user's needs in order to offer the perfect experience. This disruptive product merges different treatment concepts in just one session without the need for a therapist, using only the latest technology.

Offer unique experiences with Moodify. Create a 2.0 Wellness area including the version that best fits your project.



MOODIFY ROOM

The minimal proposal

MOODIFY AMBIENT

The modular proposal

MOODIFY SPA

The luxe experience

For further information, contact the **Fluidra Projects department** (Fluidra Engineering Services).

WWW.MOODIFY.TECH /

CHANGE YOUR
MOOD



COMMERCIAL POOLS

DEHUMIDIFICATION



780 DEHUMIDIFIERS

- 780 BDP Confort Dehumidifying Unit
- 781 AirPool
- 782 AirPool+
- 783 Optional U.V. disinfection system

BDP Confort Dehumidifying Unit



Web
Dehumidifier configurator:
www.astralpool.com ->
Calculation tools

OPTIONAL U.V. DISINFECTION SYSTEM
More info in page 783

DESCRIPTION

The BDP Confort heat pump is used for the dehumidification of indoor pools, using the latent heat of evaporation and the performance of the system itself to heat the pool water and the room air.

The energy savings achieved with these systems compared to traditional heating systems mean that they are virtually essential when you wish to heat an indoor pool. The wide range of models covers all market requirements.

- Made of non-corrosive magnesium coated aluminium.
- Thermal-acoustic inside insulation.
- Direct transmission single centrifugal ventilator. Radial Ventilator Optional.
- Air filter can be changed for a G4 type filter.
- Condensation collection gutter with drainpipe.
- A copper nitrogen, dehydrated and deoxidized refrigerated circuit. Air condensation.
- Ozone-safe R407C refrigerant gas charge (ecological).
- Evaporation, condensation and hot water batteries made of copper pipes with lacquered aluminium fins (specially designed for corrosive environments).
- Airtight compressor mounted on anti-vibration mounts.
- Pressure balancing expansion valve.
- High and low pressure switch.
- General security switch.
- Power source, compressor and ventilator motor protection mechanisms.
- Full adjustment of all the items included.
- Three-way valves and their regulation when a hot water coil is incorporated.

OPTIONAL

- 1 or 2 stage electric heating option to support air heating.
- Hot water coil to support air heating, with three-way valve, temperature probe and regulation (ask about primary temperatures different to standard equipment).
- Freecooling or mixed chamber and shutter to bring in outside air.
- Optional enthalpic regulation in the case of freecooling.

GENERATION OPERATING CONDITIONS

The thermo-hygrometric conditions for these facilities that are considered optimal for materials and people include:

- Air 28°C - 30°C
- 65% HR
- Water 2°C below air temperature.

TECHNICAL FEATURES

Model		BDP-4	BDP-5	BDP-6	BDP-8	BDP-10	BDP-12	BDP-16	
Dehumidification CAP. ⁽¹⁾	l/h	4,2	5,2	5,9	8,3	11	12,5	17,35	
Air condensation power	kW	7.1	8.5	11.6	12.4	13.8	19.1	26.7	
COOLING CIRCUIT									
Type of compressor		ROTARY							
Gas Load	Kg.	3	3,5	4	5	9	9	10	
Voltage	V/Ph/Hz	230 / 1 / 50			400 / 3 / 50				
Max. Consumption	kW	1,8	2,4	3,71	3,66	4,33	5,49	6,81	
FANS									
Type		CENTRIFUGAL							
Air flow rate	m ³ /h	1000	1200	1800	2800	3800	4300	5500	
Total available pressure ⁽²⁾	mca	15	15	20	20	20	20	20	
Max. consumption kW	RETURN	0,2	0,2	0,25	0,55	1,1	1,1	3,00	
OTHER DATA									
Ø Drain	mm	22							
Noise level AT 1 M	dB	68			69		70		
Weight	kg	100	110	160	182	270	360	448	
Air filters		G4							
OPTIONAL									
Electric heating power	W	5.0	-	-	-	-	-	-	
Hot water coil power	Power	11.6	22.2		35.8		54.9		
	Primary T.	90							
		70							
	Flow rate	l/h	500	500	990	990	1590	1590	2420
	Connection	Inches	3/4"	3/4"	3/4"	3/4"	3/4"	3/4"	3/4"

(1) For 28 °C air T. 65% RH, 24 °C water T

(2) Return plus suction

DEHUMIDIFIERS

AirPool



Fluidra Connect compatible

OPTIONAL U.V. DISINFECTION SYSTEM
More info in page 783

DESCRIPTION

The AIRPOOL dehumidifier is used to dehumidify covered pools by harnessing the latent heat from vaporisation and the very output of the equipment in heating the basin water and pool ambient air, recovering the energy needed and controlling air temperature and relative humidity.

STRUCTURE

- The structure is made from aluminium profiles with reinforced nylon on the corners.
- The housing is a 25 mm sandwich panel with IDROTEC polyurethane and auto-close handles, classifying the equipment as tightness L1(M) and thermal transmission T2.
- Condensation collection gutter with drainpipe.

COOLING CIRCUIT

- Evaporation and condensation battery made out of copper pipes with lacquered aluminium fins.
- Scroll compressor.
- R-410A refrigerant gas.

AIR CIRCUIT

- G4 filter.
- Free-cooling system made up of three motorized weir flaps, mixing chamber and return fan.

REGULATORS

- Through a programmable electronic regulator.
- Return air and outside air humidity and temperature probes, and a pool water temperature probe.
- Dirty filter pressure switches.
- Control of the pool water circulation pump through a voltage-free contact.
- Free-cooling weir flap servomotors.

OPTIONAL

- Harnesses the energy in the air discharged from the high-performance crossflow recuperator (according to Spain's RITE Regulation for Thermal Installations in Buildings)
- High-performance backup hot water coil manufactured in copper piping and lacquered aluminium fins specially designed for corrosive atmospheres. Includes a 3-way proportional valve. Controls flow temperature as an optional extra.
- Titanium condensers with PVC shell and Titanium coil.
- M6 filter in pool air suction unit and exterior air inlet and F8 filter in flow unit.
- Siemens regulation with touchscreen, enthalpy control and Eco operating mode, reducing fan flow in line with setpoints.
- Electronic radial plug fan with flow rate control.
- Water-water exchanger, assembled with the water condenser as a series feature.
- Increased air and pressure flow available in fans.
- External condenser.
- Weatherproofed.
- Optional CO₂ probes for controlling the quality of the air and adjusting it.
- Remote management.
- AND/OR preventive maintenance.
- AND/OR warranty extension.
- Start-up.

TECHNICAL FEATURES

Model		AIRPOOL-9	AIRPOOL-14	AIRPOOL-18	AIRPOOL-25	AIRPOOL-35	AIRPOOL-45	AIRPOOL-55	AIRPOOL-70	AIRPOOL-85	AIRPOOL-110	AIRPOOL-140	AIRPOOL-180
Reference		67665	67666	67667	67668	67669	67670	67671	67672	67673	67674	67675	67676
Voltage	V/Ph/Hz	230/1/50 400 / 3 / 50											
Dehumidification ⁽¹⁾	kg/h	8.4	14.1	18.6	27.0	34.5	47.1	54.3	71.2	86.5	108.0	136.9	177.8
Dehumidification ⁽²⁾	kg/h	11.6	18.0	23.0	34.4	42.7	59.0	69.1	88.9	108.0	135.0	177.0	231.0
Dehumidification ⁽³⁾	kg/h	6.1	10.3	12.7	16.6	22.9	30.9	34.5	46.0	57.0	72.2	90.9	116.5
Air flow rate	m ³ /h	1800	2500	3800	5500	7000	10000	12000	15000	18000	22000	30000	40000
Crossflow recuperator	m ³ /h	540	750	1140	1800	2100	3000	3600	4500	5500	7000	10000	13500
Air battery power (80-60°C)	kW	14.3	22.1	29.3	40.7	54.2	78.3	88.1	111.5	134.1	167.1	237.5	293.8

(1) Local 28°C 65% hr with 30% outside air 20°C 70% hr. With recuperator.

(2) VDI 2089 Local 30°C 54% hr with 30% outside air 5°C 80% hr. With recuperator.

(3) Local 28°C 65% hr in recirculation.



Only heats air



Dehumidification through alpha circuit



Dehumidification through alpha circuit with air renewal



Full air renewal



OPTIONAL UV. DISINFECTION SYSTEM

More info in page 783

DESCRIPTION

The new high performance AIRPOOL + dehumidifier is used for dehumidifying indoor pools. Thanks to its design, in which the cooling circuit components are distributed differently to conventional dehumidifiers, it uses the dehumidified air to recover heat. By optimising its various operating modes, huge savings can be made in running a pool.

STRUCTURE

- The structure is made from aluminium profiles with reinforced nylon on the corners.
- The housing is a 45 mm sandwich panel with IDROTEC polyurethane and auto-close handles, classifying the equipment as tightness L1(M) and thermal transmission T2.
- Condensation collection gutter with drainpipe.
- Equipment interior with painted sheet metal for greater durability against chlorine degradation.

COOLING CIRCUIT

- High-performance evaporation and condensation batteries manufactured in copper piping and lacquered aluminium fins.
- Scroll compressor.
- R-410A refrigerant gas.

AIR CIRCUIT

- M6 filter in pool air suction unit and exterior air inlet and F8 filter in flow unit.
- Radial plug fans with flow rate control
- Free-cooling system made up of three motorized weir flaps, mixing chamber and return fan.
- Harnesses the energy in the air discharged from the crossflow recuperator from 100% of flow
- Back-up water heating battery. With three-way proportional valve and flow-rate temperature control.

REGULATORS

- Siemens regulation with touchscreen, absolute humidity control and Eco operating mode, reducing fan flow in line with setpoints.
- Return air and outside air humidity and temperature probes, and a pool water temperature probe.
- Dirty filter pressure switches.
- Control of the pool water circulation pump through a voltage-free contact.
- Servomotors for free-cooling weirs.

OPTIONAL

- Increase in air flow rate (involves rise in heating battery power)
- Titanium condensers with PVC shell and Titanium coil.
- Water-water exchanger, assembled with the water condenser as a series feature.
- Equipment can be operated in reverse to expel surplus heat from the facility.
- Weatherproofed.
- Optional CO₂ probes for controlling the quality of the air and adjusting it.
- ModBus.
- Remote management.
- AND/OR preventive maintenance.
- AND/OR warranty extension.
- Start-up.

TECHNICAL FEATURES

Model		AIRPOOL+ 12	AIRPOOL+ 22	AIRPOOL+ 30	AIRPOOL+ 44	AIRPOOL+ 54	AIRPOOL+ 70	AIRPOOL+ 84	AIRPOOL+ 108	AIRPOOL+ 132	AIRPOOL+ 175
Reference		67677	67678	67679	67680	67681	67682	67683	67684	67685	67686
Voltage	V/Ph/Hz	220/1/50 400 / 3 / 50									
Dehumidification ⁽¹⁾	kg/h	13.4	22.3	21.7	44.3	53.6	70.9	84.2	110.7	133.4	177.6
Dehumidification ⁽²⁾	kg/h	25.6	30.2	57.1	85.6	102.3	136.8	162.4	213.7	256.2	342.3
Dehumidification ⁽³⁾	kg/h	8.0	12.8	12.3	25.0	37.8	42.5	50.6	66.5	83.7	130.9
Air flow rate	m ³ /h	2100	3500	4900	7000	8400	11200	13300	17500	21000	28000
Recuperator efficacy ⁽¹⁾	%	67	69	71	68	73	70	70	70	68	68
Air battery power (90-70°C)	kW	20.4	38.7	48.5	71.0	87.9	106.7	134.2	177.8	216.5	273.0

(1) Local 28°C 65% hr with 30% outside air 20°C 70% hr.

(2) VDI 2089 Local 30°C 54% hr with 30% outside air 5°C 80% hr.

(3) Local 28°C 65% hr in recirculation.

Optional U.V. disinfection system

DESCRIPTION



Optional U.V. disinfection system, fitted in evaporators or in air treatment system in air ducts to, is a highly effective way to destroy microorganisms including: virus, bacteria, and mold spores.

Short wave UV light (UVC) penetrates the cell structure of the micro-organism and destroys the DNA structure and thereby prevents it from replicating.

This method of purification is ideal for dehumidifiers because it is completely safe, fast and easy with simple use and maintenance.



COMMERCIAL POOLS

HEATING



786 SWIMMING POOL HEATING SOLUTIONS

788 HEAT PUMPS

788 ProHeat II

790 ProHeat II Indoor

792 ELECTRIC HEATERS

794 WATER-WATER EXCHANGERS

794 Waterheat EVO

795 Equipped Waterheat

796 WATER-WATER PLATE HEAT EXCHANGER

796 Etna

Commercial pool heating solutions

Parameters for choosing a heating system

To define a system suitable for a pool, many parameters need to be considered. The most important parameters (but non-exhaustive) are the ones below:

1. Average outdoor air temperature (°C)
2. Pool water target temperature (in °C)
3. Period of use
4. Pool volume (m³)
5. Presence of an isothermal cover or not
6. Filtration time

To consider all the parameters which impact the sizing of a heating system, online AstralPool configurators are available:

- For professional use, visit our Profluidra website.
- For public use, visit our simplified configurator on AstralPool website.

The choice of heating equipment also depends on the energy source that will be used.

Understand the concept of performance

To compare the performance of different heat pumps, it is essential to compare restituted power and performance coefficient.

Two main values characterise the performance of heat pumps: their power and their performance coefficient.

- **Power**, expressed in kW, indicates the quantity of heat transferred to the water. It is expressed in specific climatic conditions to which the heat pump is exposed during use:
 - Temperature of the outside air (in °C)
 - Humidity of the outside air (in %)
 - Temperature of the water in the pool (in °C)

- **The coefficient of performance (COP)** is the ratio between the restituted power and the power consumption of the heat pump. As a result, it is the ratio at specific climatic conditions too.

As an example, a performance coefficient of 5 means that for 1 kWh consumed at the electricity meter, the heat supplies 5 times more energy to the water in the pool, or 5 kWh.

So the higher the performance coefficient, the more efficient the system.

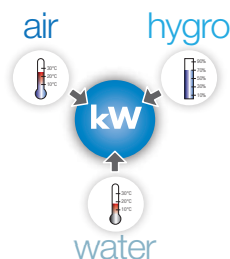

CLIMATE ZONES

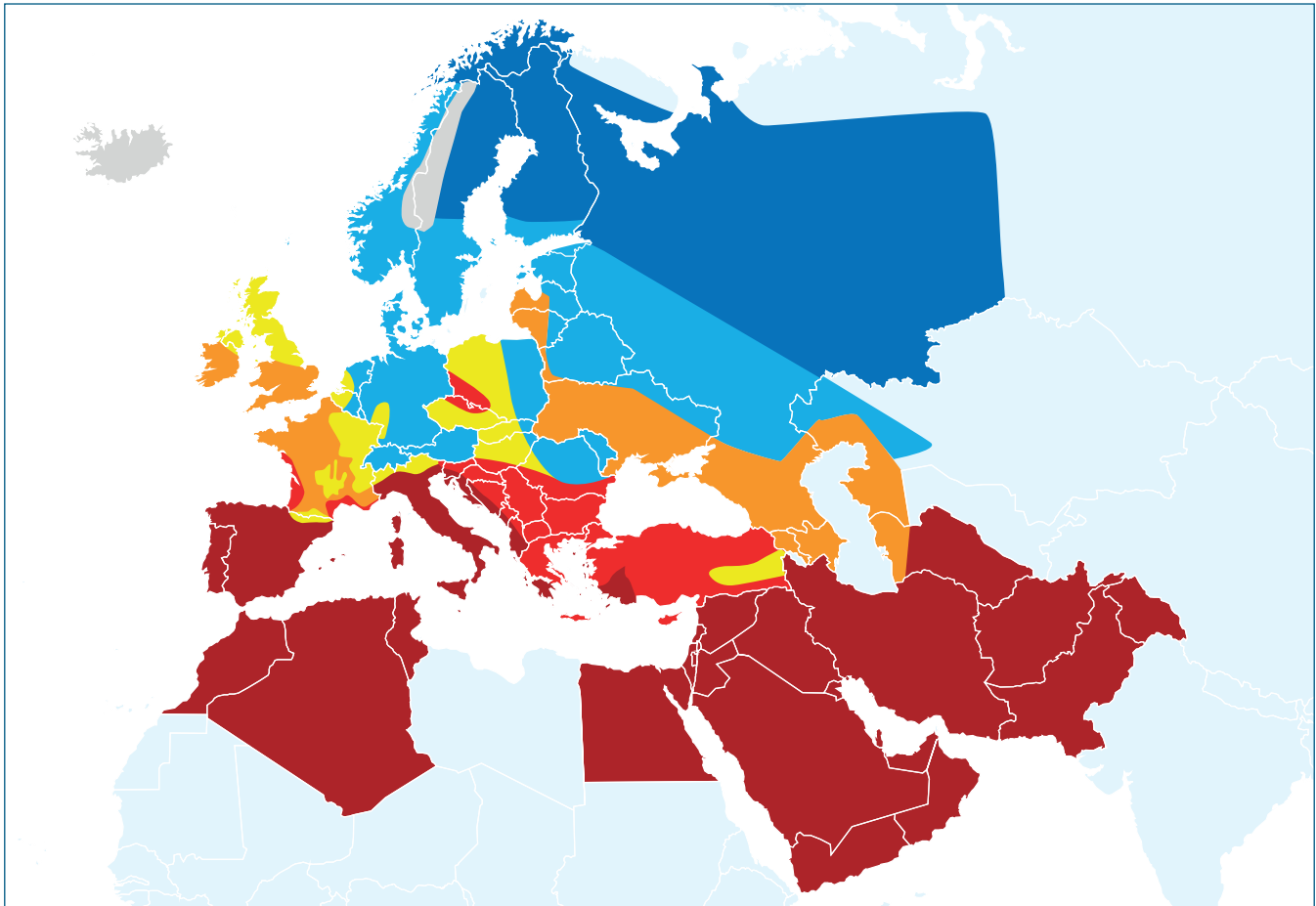

SOUTH AFRICA

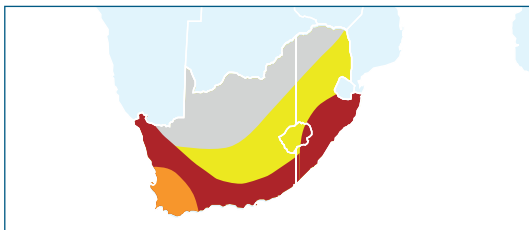

AUSTRALIA

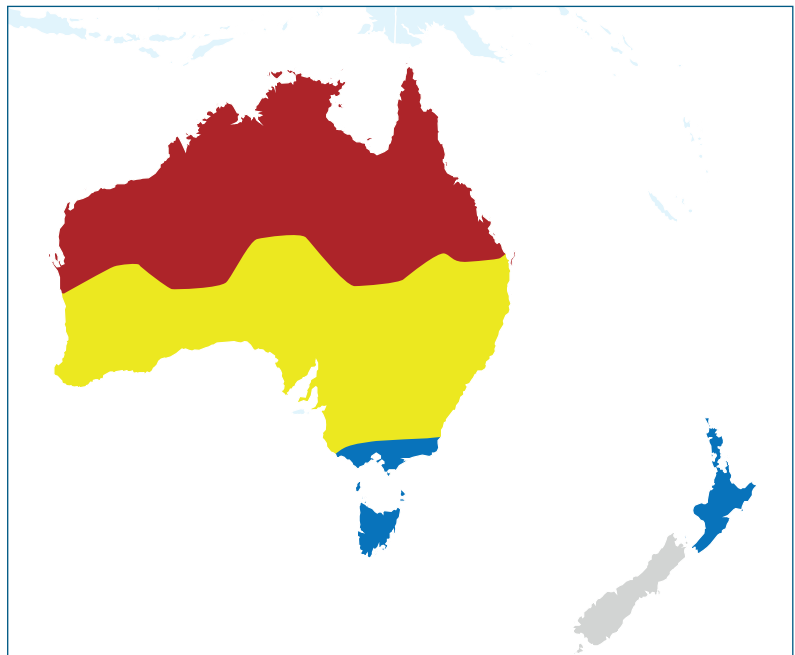

Pool location zones

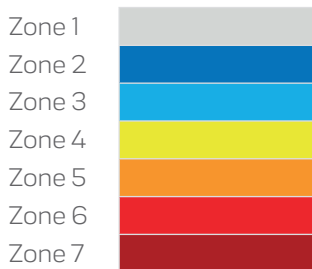

Caribbean Islands, Reunion Island, Canary Islands are part of Zone 7.

ProHeat II



Fluidra Connect compatible



Web
Heat pump configurator:
www.astralpool.com ->
Calculation tools

DESCRIPTION

- 0°C minimum outdoor air temperature.
- 2 models: Standard and Chiller.
- Digital display.
- Heating priority mode (filtration pump control).
- Robust, lightweight casing made from corrosion-resistant magnesium coated aluminium.
- Axial ventilator.
- Automatic cooling mode for chiller model.
- Automatic defrosting.
- HP & LP safety pressure switch.
- Water flow switch.
- G2 Titanium water exchanger condensers. Guaranteed against corrosion.
- Scroll compressor.
- Thermostatic expansion valve, with external balancing unit.
- High performance evaporator battery in an inner corrugated copper tube with lacquered aluminium fins, especially for corrosive environments.
- Control of purifying system.
- Automatic electrical protections.

TECHNICAL FEATURES

Model		PROHEAT II 35	PROHEAT II 45	PROHEAT II 60	PROHEAT II 90	PROHEAT II 120
Reference	STANDARD	65542-MOB	65543-MOB	65544-MOB	65545-MOB	65546-MOB
	CHILLER	68245-MOB	68246-MOB	68247-MOB	68248-MOB	68249-MOB
Refrigerant FLUID		R-410A				
Recommended water flow	m ³ /h	12-15	15-25	25-35	30-50	50-70
Hydraulic connection	mm	63		75		
Electric power supply	V/Ph/Hz	400/3/50				
Refrigerant fluid quantity	Kg	4	6	9	2 x 6.5	2 x 9
Number of fans		1			2	
Sound level	dB(A) (d*)	66.2	66.2	72.5	71.1	71.1
	dB(A) (5m)	60.9	60.9	68.4	69.4	69.4

HEATING PERFORMANCE

Standard models		PROHEAT II 35	PROHEAT II 45	PROHEAT II 60	PROHEAT II 90	PROHEAT II 120
AIR 25°C / WATER 26°C						
Heating capacity	(kW)	36.2	44.4	63.5	91.3	125.5
Power consumption	(kW)	6.4	8.2	11.9	17.0	24.3
COP		5.7	5.4	5.3	5.4	5.2
AIR 15°C / WATER 26°C						
Heating capacity	(kW)	30.5	39.7	56.8	80.2	110.5
Power consumption	(kW)	6.2	8.1	11.5	16.8	23.9
COP		4.9	4.9	4.9	4.8	4.6
AIR 5°C / WATER 26°C						
Heating capacity	(kW)	23.2	30.0	41.3	61.0	80.1
Power consumption	(kW)	6.0	7.9	10.7	16.2	22.7
COP		3.9	3.8	3.9	3.8	3.5

COOLING PERFORMANCE

Chiller models		PROHEAT II 35	PROHEAT II 45	PROHEAT II 60	PROHEAT II 90	PROHEAT II 120
AIR 30°C / WATER 26°C						
Cooling capacity	(kW)	42.3	51.0	72.0	104.0	140.0
Power consumption	(kW)	7.0	8.4	12.0	17.3	24.4
EER		6.0	6.1	6.0	6.0	5.7
AIR 43°C / WATER 32°C						
Cooling capacity	(kW)	29.1	37.0	49.5	74.0	99.0
Power consumption	(kW)	9.4	11.9	15.6	24.5	31.2
EER		3.1	3.1	3.2	3.0	3.2

NOTE: d* = As per UNE-EN 12102/ISO 3744:2010.

STANDARD AND CHILLER MODELS - WEIGHT AND DIMENSIONS

Model			PROHEAT II 35	PROHEAT II 45	PROHEAT II 60	PROHEAT II 90	PROHEAT II 120
Weight	kg		185	210	287	447	500
Dimensions 	mm	A	1000		1700	2100	2400
		B	950		1200		
		C	1140		1200	1500	1700

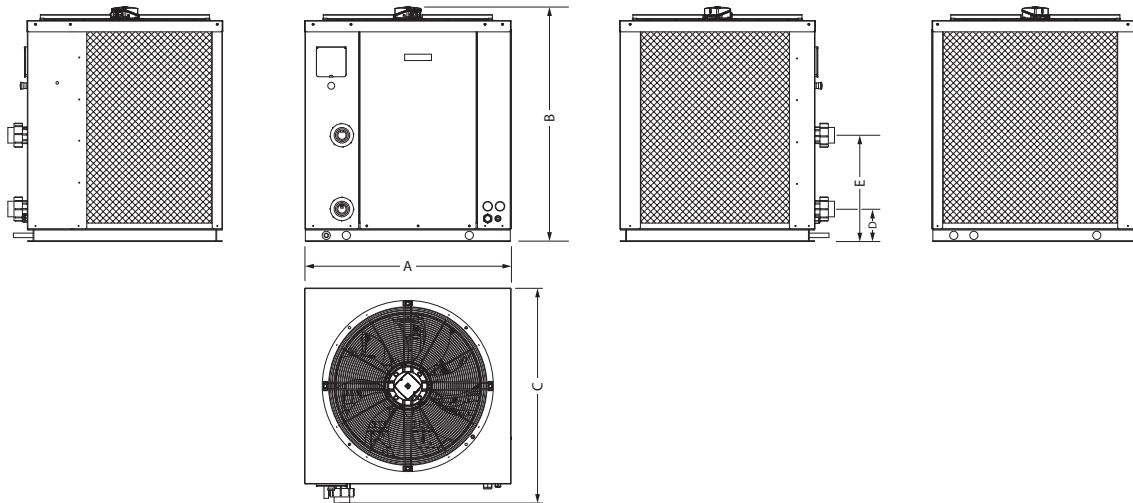

CLIMATE ZONES

This table is a sizing help tool. It is given for a private pool, from 15th May to 15th September, depth 1.5m, with a maximum temperature rise time of 4 days to heat the pool from 15°C to 28°C, 14h filtration time. Climatic zones details can be found in the introduction pages of the Heating chapter p. 971 To get a customized sizing, please consult the web configurators:
 For professional use, visit our configurator on www.pro.fluidra.com
 For public use, visit our simplified configurator on www.astralpool.com

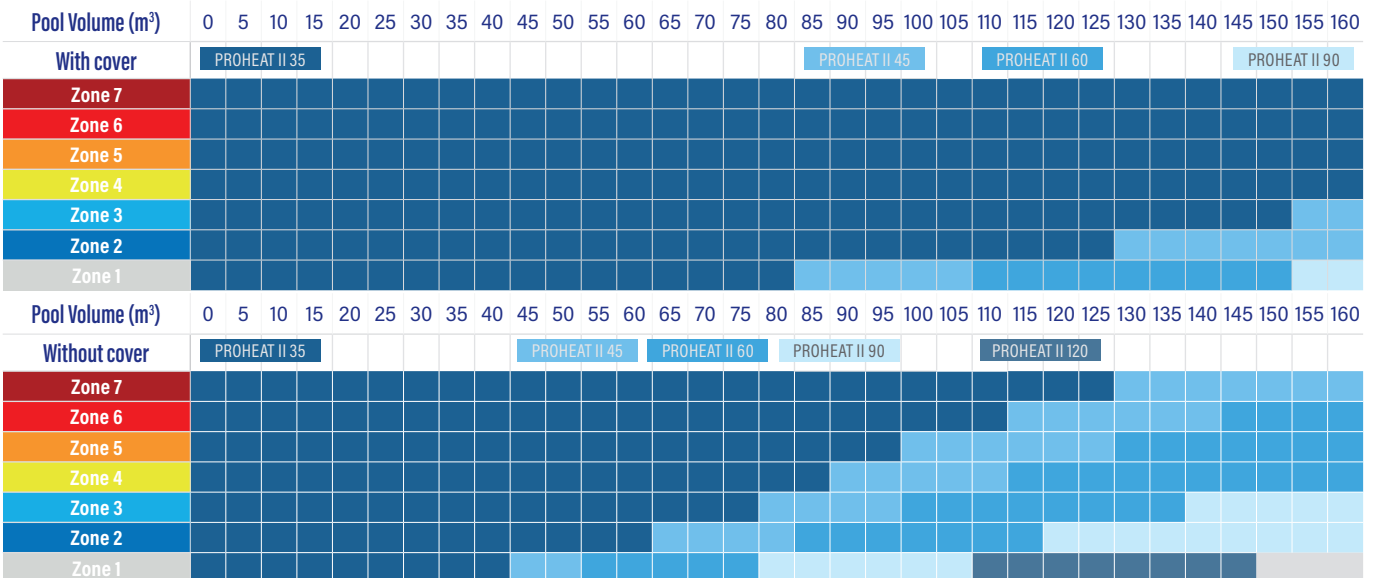

ProHeat II Indoor



Fluidra Connect compatible

Web

Heat pump configurator:
www.astralpool.com ->
 Calculation tools

DESCRIPTION

- 0°C minimum outdoor air temperature.
- Digital display, easy-to-use control panel, with display of current temperature, setpoint and alarm messages.
- Heating priority mode (filtration pump control).
- Robust, lightweight casing made from corrosion-resistant magnesium coated aluminium.
- Axial ventilator.
- Automatic cooling mode (chiller model).
- Automatic defrosting.
- HP & LP safety pressure switch.
- Water flow switch.
- G2 Titanium water exchanger condensers. Guaranteed against corrosion.
- Scroll compressor.
- Thermostatic expansion valve, with external balancing unit.
- High performance evaporator battery in an inner corrugated copper tube with lacquered aluminium fins, especially for corrosive environments.
- Control of purifying system.
- Automatic electrical protections.
- Centrifugal fans so the unit will be installed in a technical room, using air ducting.

TECHNICAL FEATURES

Model		PROHEAT II IND-35	PROHEAT II IND-45	PROHEAT II IND-60	PROHEAT II IND-90	PROHEAT II IND-120
Reference		69649-MOB	69650-MOB	69651-MOB	69652-MOB	69653-MOB
Refrigerant FLUID		R-410A				
Recommended water flow	m ³ /h	12-15	15-25	25-35	30-50	50-70
Hydraulic connection	mm	63		75		
Electric power supply	V/Ph/Hz	400/3/50				
Refrigerant fluid quantity	Kg	6	9	12	2 x 7	2 x 9
Number of fans		1			2	
Sound level	dB(A) (d*)	59.2	59.6	60.0	61.1	61.5
	dB(A) (5m)	55.4	55.8	56.1	56.5	56.6

HEATING PERFORMANCE

Model		PROHEAT II IND-35	PROHEAT II IND-45	PROHEAT II IND-60	PROHEAT II IND-90	PROHEAT II IND-120
AIR 25°C / WATER 26°C						
Heating capacity	(kW)	43.6	44.4	63.5	91.3	125.5
Power consumption	(kW)	6.7	9.4	11.8	18.7	23.6
COP		6.5	6.0	6.0	6.0	6.0
AIR 15°C / WATER 26°C						
Heating capacity	(kW)	34.9	45.0	57.5	90.1	114.9
Power consumption	(kW)	6.4	8.6	11.0	17.1	22.1
COP		5.4	5.3	5.2	5.3	5.2
AIR 5°C / WATER 26°C						
Heating capacity	(kW)	27.4	35.2	45.2	70.5	90.3
Power consumption	(kW)	6.5	8.5	11.2	16.9	22.3
COP		4.2	4.2	4.1	4.2	4.1

NOTE: d* = As per UNE-EN 12102/ISO 3744:2010.

STANDARD AND CHILLER MODELS - WEIGHT AND DIMENSIONS

Model			PROHEAT II IND-35	PROHEAT II IND-45	PROHEAT II IND-60	PROHEAT II IND-90	PROHEAT II IND-120
Weight	kg		315	391	437	648	757
Dimensions 	mm	A	1610	1910		1922+50	2400-100
		B	1160+100	1197+100		2110+100	2024+50
		C	1347+50	1497+50		1590+50	1670+50



CLIMATE ZONES

This table is a sizing help tool. It is given for a private pool, from 15th May to 15th September, depth 1.5m, with a maximum temperature rise time of 4 days to heat the pool from 15°C to 28°C, 14h filtration time. Climatic zones details can be found in the introduction pages of the Heating chapter p. 971 To get a customized sizing, please consult the web configurators:
 For professional use, visit our configurator on www.pro.fluidra.com
 For public use, visit our simplified configurator on www.astralpool.com

Pool Volume (m³)	0	5	10	15	20	25	30	35	40	45	50	55	60	65	70	75	80	85	90	95	100	105	110	115	120	125	130	135	140	145	150	155	160		
With cover	PROHEAT 2 35																				PROHEAT 2 45					PROHEAT 2 60					PROHEAT 2 90				
Zone 7	[Dark Blue]																																		
Zone 6	[Dark Blue]																																		
Zone 5	[Dark Blue]																																		
Zone 4	[Dark Blue]																																		
Zone 3	[Dark Blue]																																		
Zone 2	[Dark Blue]																																		
Zone 1	[Dark Blue]																																		
Without cover	PROHEAT 2 35					PROHEAT 2 45					PROHEAT 2 60					PROHEAT 2 90					PROHEAT 2 120														
Zone 7	[Dark Blue]																																		
Zone 6	[Dark Blue]																																		
Zone 5	[Dark Blue]																																		
Zone 4	[Dark Blue]																																		
Zone 3	[Dark Blue]																																		
Zone 2	[Dark Blue]																																		
Zone 1	[Dark Blue]																																		

Commercial electric heat

(incoloy version)



DESCRIPTION

Commercial electric heat is suitable to heat the water temperature from small to large collective pools.

- Positive safety high temperature limiter (60°C).
- Digital display.
- Flow switch.
- Power contactors.
- Temperature control thermostat from 0 to 40°C.
- Precision thermostat: 0.1°C.

TECHNICAL FEATURES

Model		Electric heat 24	Electric heat 30	Electric heat 36	Electric heat 42	Electric heat 48	Electric heat 54	Electric heat 60	Electric heat 72	Electric heat 84	Electric heat 96	Electric heat 108	
Reference		51845	51846	51847	44741	44742	44743	44744	44745	44746	44747	44748	
Power 90°C	kW	24	30	36	42	48	54	60	72	84	96	108	
Electrical supply	V/Ph/Hz	400V/50Hz/3Ph											
Min. water flow rate	m³/h	15											
Max. water flow rate	m³/h	30											
Service pressure		2											
Max. pressure	Kg	3											
Hydraulic water connection	dB (A)	50									65		
Max. absorbed intensity	Units	36	45	54	65	74	82	91	109	127	146	165	

DIMENSIONS AND WEIGHT

Model		Electric heat 24	Electric heat 30	Electric heat 36	Electric heat 42	Electric heat 48	Electric heat 54	Electric heat 60	Electric heat 72	Electric heat 84	Electric heat 96	Electric heat 108	
Dimensions	A (mm)	510											
	B (mm)	640					915						
	C (mm)	160											
	D (mm)	2"					2 1/2"						
	E (mm)	435											
Gross weight	kg	24	26	28	32	34	36	38	44	46	48	50	
Net weight	kg	18	20	22	26	28	30	32	36	38	40	42	

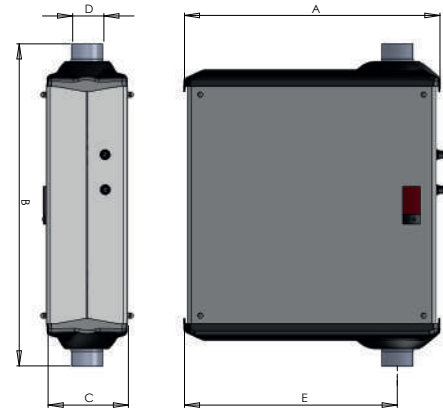

CLIMATE ZONES

This table is a sizing help tool. It is given for a private pool, from 15th May to 15th September, depth 1.5m, with a maximum temperature rise time of 4 days to heat the pool from 15°C to 28°C, 14h filtration time. Climatic zones details can be found in the introduction pages of the Heating chapter p. 971 To get a customized sizing, please consult the web configurators:
 For professional use, visit our configurator on www.pro.fluidra.com
 For public use, visit our simplified configurator on www.astralpool.com

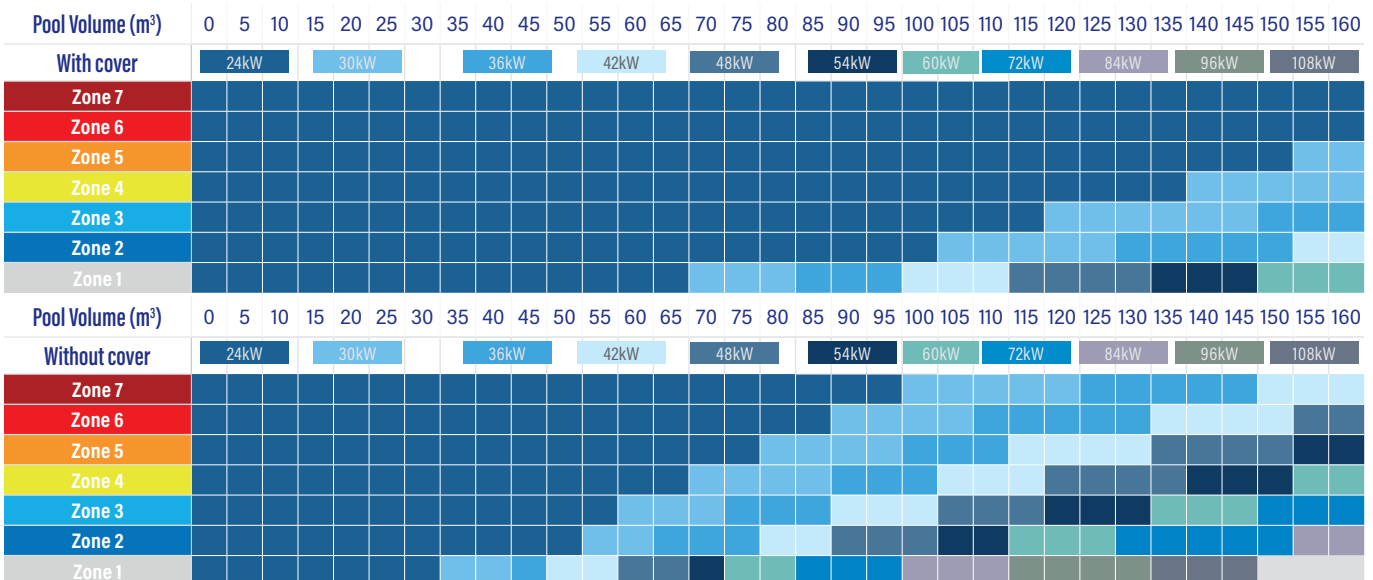

Waterheat EVO



DESCRIPTION

Heat exchanger suitable for warming the water temperature of pools and SPAS, thanks to the heat exchange between the primary circuit (warm area) and a secondary one (cold area that we want to warm).

- Titanium housing (secondary, pool water).
- Titanium coil (primary, water for boiler).
- Primary working pressure of 10 bar.
- Secondary working pressure of 3 bar.

PRODUCT REFERENCES

Model	TIT-20 kW	TIT-40 kW	TIT-60 kW	TIT-105 kW	TIT-140 kW	TIT-210 kW	TIT-300 kW	TIT-450 kW
Reference	71607	71608	71609	71610	71611	71612	71613	71614

TECHNICAL FEATURES

Model		TIT-20 kW	TIT-40 kW	TIT-60 kW	TIT-105 kW	TIT-140 kW	TIT-210 kW	TIT-300 kW	TIT-450 kW
Power	90°C	20	40	60	105	140	210	300	450
	60°C	10	20	30	40	60	80	120	210
	45°C	5	10	15	20	3	40	60	100

HEATING PERFORMANCE

Model		TIT-20 kW	TIT-40 kW	TIT-60 kW	TIT-105 kW	TIT-140 kW	TIT-210 kW	TIT-300 kW	TIT-450 kW
Heater	m ³ /h	1.6	2.7	3.1	6.6	7.0	10.0	11.0	16.0
Heater load loss	bar	0.006	0.024	0.040	0.030	0.040	0.122	0.214	0.470
Heater connection	Inch	G ¾"			G 1½"				
Pool volume	m ³ /h	11	15	20	23	20	25	20	21
Pool head loss	bar	0.119	0.192	0.418	0.293	0.316	0.633	0.596	0.860
Pool connection	Inch	G 1"			G 1½"				

DIMENSIONS AND WEIGHT

Model		TIT-20 kW	TIT-40 kW	TIT-60 kW	TIT-105 kW	TIT-140 kW	TIT-210 kW	TIT-300 kW	TIT-450 kW
Dimensions	 A (mm)	122			140				
	B (mm)	75	175	225	170	270	420	670	920
	C (mm)	290	390	440	357	457	607	857	1107
	ØDz	80			102				
Weight	kg	1.2	1.7	1.9	2.2	2.7	3.8	5.3	6.8

Consult your service engineer about the right selection of unit depending on your installation.
 Figures for power settings calculated for pool water at 20°C.

Diagram of assembly below the water level:

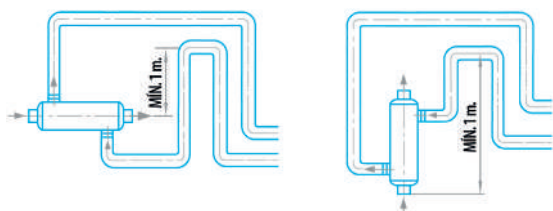
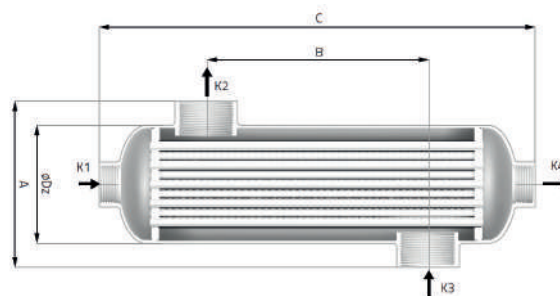
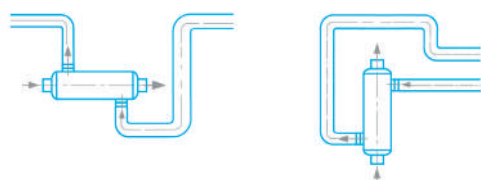

Diagram of assembly below the water level:



Equipped Waterheat



DESCRIPTION

Heat exchanger suitable for warming the water temperature of pools and SPAS, thanks to the heat exchange between the primary circuit (warm area) and a secondary one (cold area that we want to warm).

- Regulator with secondary pump control, voltage free contact and timer.
- Casing built in Alucoil and ABS plastic.
- Body made in Titanium (secondary, water from pool).
- Coils made in titanium alloy (primary, water from boiler).
- Fully fitted, anti-return valve, primary recirculation pump and control thermostat with immersion probe.
- Primary work pressure 10 bars and secondary work pressure 3 bars.

CONNECTIONS:

- Primary (heating): 1".
- Secondary (pool): D-50 three piece link.

PRODUCT REFERENCES

Model	TIT-20 kW	TIT-40 kW	TIT-60 kW
Reference	43506	43507	43508

TECHNICAL FEATURES

Model		TIT-20 kW	TIT-40 kW	TIT-60 kW
Power	90°C	20	40	60
	60°C	10	20	30
	45°C	5	10	15

HEATING PERFORMANCE

Model		TIT-20 kW	TIT-40 kW	TIT-60 kW
Heater	m³/h	1.6	2.7	3.0
Heater load loss	bar	0.12	0.41	0.70
Heater connection	Inch	-	-	-
Pool volume	m³/h	10	15	20
Pool head loss	bar	0.14	0.24	0.29
Pool connection	Inch	-	-	-

DIMENSIONS AND WEIGHT

Model		TIT-20 kW	TIT-40 kW	TIT-60 kW
Dimensions 	A (mm)	530	530	530
	B (mm)	450	590	650
	C (mm)	160	160	160
	D (mm)	215	225	305
	E (mm)	1"	1"	1"
Weight	kg	10	11	18

Consult your service engineer about the right selection of unit depending on your installation.
 Figures for power settings calculated for pool water at 20°C.

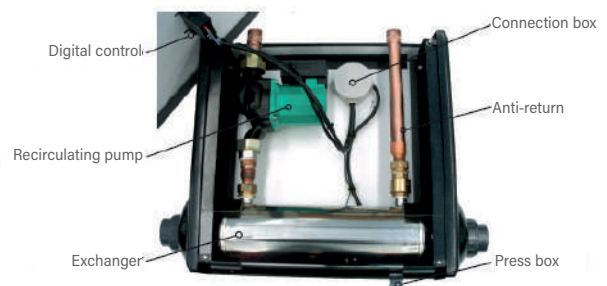
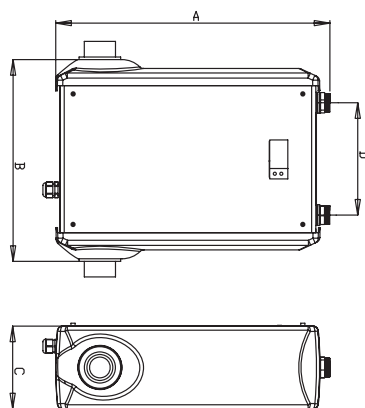

Etna



Basic model

- Corrugated plates in AISI-316 or titanium.
- EPDM gaskets.
- Housing in epoxy painted carbon steel.
- In non-equipped heat exchangers, AISI-316 stainless steel connections in ISO G2 direct thread.
- In equipped heat exchangers, primary connections in copper, and secondary in PVC.
- In equipped heat exchangers, full regulation, with control of the filtering pump. Double display (setpoint and current reading).
- Simple recirculating pump in the primary circuit is optional.



Equipped model



Equipped model + recirculating pump

ETNA 15 - ETNA 200

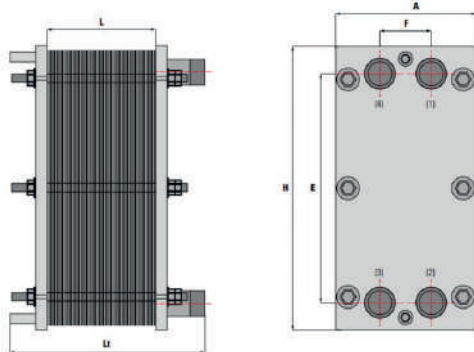

ETNA EQUIPPED

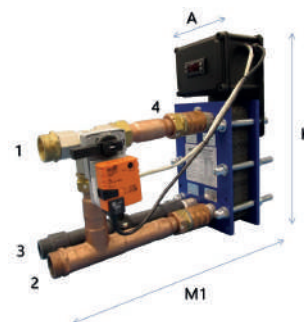

ETNA 250 - ETNA 580

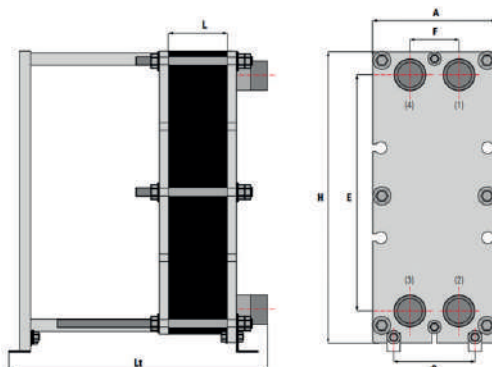

ETNA EQUIPPED + PUMP

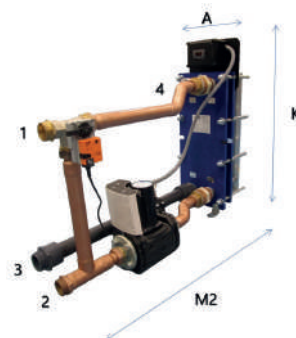

- 1 – Primary, inlet.
- 2 – Primary, outlet.
- 3 – Secondary, inlet.
- 4 – Secondary, outlet.

PRODUCT REFERENCES

Model	AISI-316 codes			Titanium codes		
	Basic model	Equipped model	Model Eq+B ⁽¹⁾	Basic model	Equipped model	Model Eq+B ⁽¹⁾
	Ref.	Ref.	Ref.	Ref.	Ref.	Ref.
ETNA-15	67985	68230	68021	67994	68012	68030
ETNA-35	68223	68004	68022	67995	68013	68031
ETNA-50	68224	68005	68023	67996	68014	68032
ETNA-60	68225	68006	68024	67997	68015	68033
ETNA-90	67989	68007	68025	67998	68016	68034
ETNA-120	67990	68008	68026	68226	68017	68035
ETNA-150	67991	68009	68027	68227	68018	68036
ETNA-180	67992	68010	68028	68228	68019	68037
ETNA-200	67993	68011	68029	68229	68020	68038
ETNA-250	32550	32563	32576	33137	33155	33173
ETNA-300	32552	32565	32578	33139	33157	33175
ETNA-350	32553	32566	32579	33140	33158	33176
ETNA-400	33114	33119	33124	33141	33159	33177
ETNA-460	33115	33120	33125	69796	33160	33178
ETNA-500	32554	32567	32580	69797	33161	33179
ETNA-580	33116	33121	33126	69798	33162	33180

(1) Eq + B: Equipped model + recirculating pump.

TECHNICAL FEATURES

Model	Code		Power		Num. Plates	Primary circuit			Secondary circuit			Dimensions (mm)					
	AISI-316	Titanium	KW	(kcal/h)		Flow rate (m³/h)	Head loss (bar)	Connections	Flow rate (m³/h)	Head loss (bar)	Connections	H	A	E	F	Lt	L
ETNA-15	67985	67994	17	15,000	5	0.75	0.3	11/4"	0.74	0.3	11/4"	320	200	235	69	220	16.5
ETNA-35	68223	67995	40	35,000	7	1.55	0.3	11/4"	1.52	0.3	11/4"	320	200	241	69	220	23.1
ETNA-50	68224	67996	58	50,000	9	2.56	0.3	11/4"	2.51	0.3	11/4"	320	200	235	69	220	29.7
ETNA-60	68225	67997	70	60,000	11	3.09	0.3	11/4"	3.03	0.3	11/4"	320	200	235	69	220	36.3
ETNA-90	67989	67998	105	90,000	15	4.64	0.3	11/4"	4.55	0.3	11/4"	320	200	235	69	220	49.5
ETNA-120	67990	68226	140	120,000	19	6.19	0.3	11/4"	6.07	0.3	11/4"	320	200	235	69	220	62.7
ETNA-150	67991	68227	174.4	150,000	23	7.71	0.3	11/4"	7.56	0.3	11/4"	320	200	235	69	220	75.9
ETNA-180	67992	68228	209	180,000	29	9.23	0.3	11/4"	9.06	0.3	11/4"	320	200	235	69	220	95.7
ETNA-200	67993	68229	233	200,000	31	10.3	0.3	11/4"	10.1	0.3	11/4"	320	200	235	69	220	102.3
ETNA-250	32550	33137	291	250,000	15	12.86	0.3	2 1/2"	12.61	0.3	2 1/2"	745	310	603	124	630	49.5
ETNA-300	32552	33139	349	300,000	17	15.42	0.3	2 1/2"	15.13	0.3	2 1/2"	745	310	603	124	630	56.1
ETNA-350	32553	33140	407	350,000	21	17.98	0.3	2 1/2"	17.64	0.3	2 1/2"	745	310	603	124	630	69.3
ETNA-400	33114	33141	465	400,000	23	20.55	0.3	2 1/2"	20.13	0.3	2 1/2"	745	310	603	124	630	75.9
ETNA-460	33115	69796	535	460,000	27	23.64	0.3	2 1/2"	23.19	0.3	2 1/2"	745	310	603	124	630	89.1
ETNA-500	32554	69797	581	500,000	29	25.67	0.3	2 1/2"	25.18	0.3	2 1/2"	745	310	603	124	630	95.7
ETNA-580	33116	69798	675	580,000	33	29.83	0.3	2 1/2"	29.26	0.3	2 1/2"	745	310	603	124	630	108.9

TECHNICAL FEATURES

Model	Code		Code		Power		Num. Plates	Dimensions (mm)				Weight
	AISI-316	Titanium	AISI-316	Titanium	KW	(kcal/h)		A	M1	M2	K	kg
ETNA-15	68230	68012	68021	68030	17	15.000	5	200	659	1148	470	38 + 4,5
ETNA-35	68004	68013	68022	68031	40	35.000	7	200	659	1148	470	38 + 4,5
ETNA-50	68005	68014	68023	68032	58	50.000	9	200	659	1148	470	39 + 9
ETNA-60	68006	68015	68024	68033	70	60.000	11	200	659	1148	470	39 + 9
ETNA-90	68007	68016	68025	68034	105	90.000	15	200	659	1148	470	40 + 9
ETNA-120	68008	68017	68026	68035	140	120.000	19	200	659	1148	470	41 + 15
ETNA-150	68009	68018	68027	68036	174,4	150.000	23	200	659	1148	470	42 + 15
ETNA-180	68010	68019	68028	68037	209	180.000	29	200	659	1148	470	43 + 15
ETNA-200	68011	68020	68029	68038	233	200.000	31	200	659	1148	470	44 + 15
ETNA-250	32563	33155	32576	33173	291	250.000	15	310	1070	1558	905	128 + 17
ETNA-300	32565	33157	32578	33175	349	300.000	17	310	1070	1558	905	129 + 17
ETNA-350	32566	33158	32579	33176	407	350.000	21	310	1070	1558	905	133 + 20
ETNA-400	33119	33159	33124	33177	465	400.000	23	310	1070	1558	905	134 + 20
ETNA-460	33120	33160	33125	33178	535	460.000	27	310	1070	1558	905	138 + 22
ETNA-500	32567	33161	32580	33179	581	500.000	29	310	1070	1558	905	139 + 22
ETNA-580	33121	33162	33126	33180	675	580.000	33	310	1070	1558	905	143 + 24



COMMERCIAL POOLS

COMPETITION MATERIALS



800 COMPETITION POOL SYSTEMS

- 800 Sparger – Safety on diving boards
- 800 Movable wall – Divides pools and multiplies their uses
- 801 Location of the equipment used in competition pools

802 SWIMMING POOL COMPETITION PODIUMS

- 802 Starting block
- 802 Starting block H-700 mobile support
- 802 Starting block H-700 anchorage
- 803 Starting blocks
- 804 Headwall for podiums
- 804 Podium fixing

805 LANE ROPES

- 805 Starting blocks numbers
- 805 BCN03 Competition lane rope model
- 806 Sydney model
- 806 Roma model
- 806 Moscow model

807 FLOATS

- 807 BCN03 model
- 807 Sydney model
- 807 Moscow model

808 LANE ROPE STORAGE EQUIPMENT

- 808 BCN03 Lane rope storage basket
- 808 Lane rope roller

809 LANE ROPE ACCESSORIES

- 809 Under deck lane rope storage system
- 809 Lane rope anchor
- 809 Concrete anchoring cup with central rod
- 810 Concrete anchoring cup with central rod
- 810 Retractable anchoring cup
- 810 Lane rope ratchet
- 811 Lane rope spring
- 811 Lane rope hook
- 811 Cords and cables
- 811 False start indicators
- 812 Backstroke turn indicators

812 TURNING PANELS

- 812 Turning panels
- 813 Bracket

813 ATTACHMENTS FOR COMPETITION EQUIPMENT

- 813 Horizontal flange anchoring sockets
- 813 Angled flange anchoring socket
- 814 Anchoring socket with locking bolts

814 WATER POLO GOAL

- 814 Water polo goal

Sparger - Safety on diving boards

- + When diving off a diving board, the undisturbed water forms a fairly resistant surface, which if combined with a bad descent can result in serious injury on impact.
- + AstralPool has added Sparger technology to its pools in the shape of a new safety system for diving pools. Air is released at high pressure from the pool floor, which forms a large amount of bubbles when it mixes with the water to form a cushion for divers. This reduces the risk of injury and divers are more confident when they dive into the water, whether they are beginners or professionals.

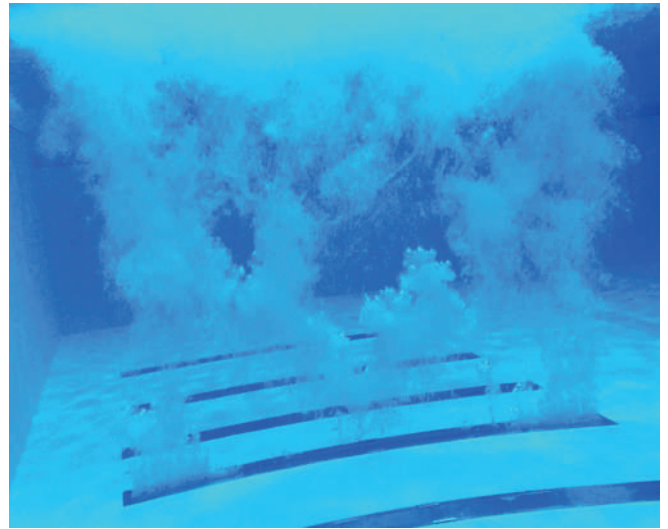

Movable wall - Divides pools and multiplies their uses



- + Technology that allows a single pool to be divided into two separate pools for different uses. This therefore makes better use of space and gives swimmers a greater variety of options for a lower overall cost.
- + The movable wall system is able to adapt to and be used in existing pools or newly built ones.
- + The movable wall is made of AISI-304 stainless steel and is lined with white plastic non-slip sheeting.

Location of the equipment used in competition pools

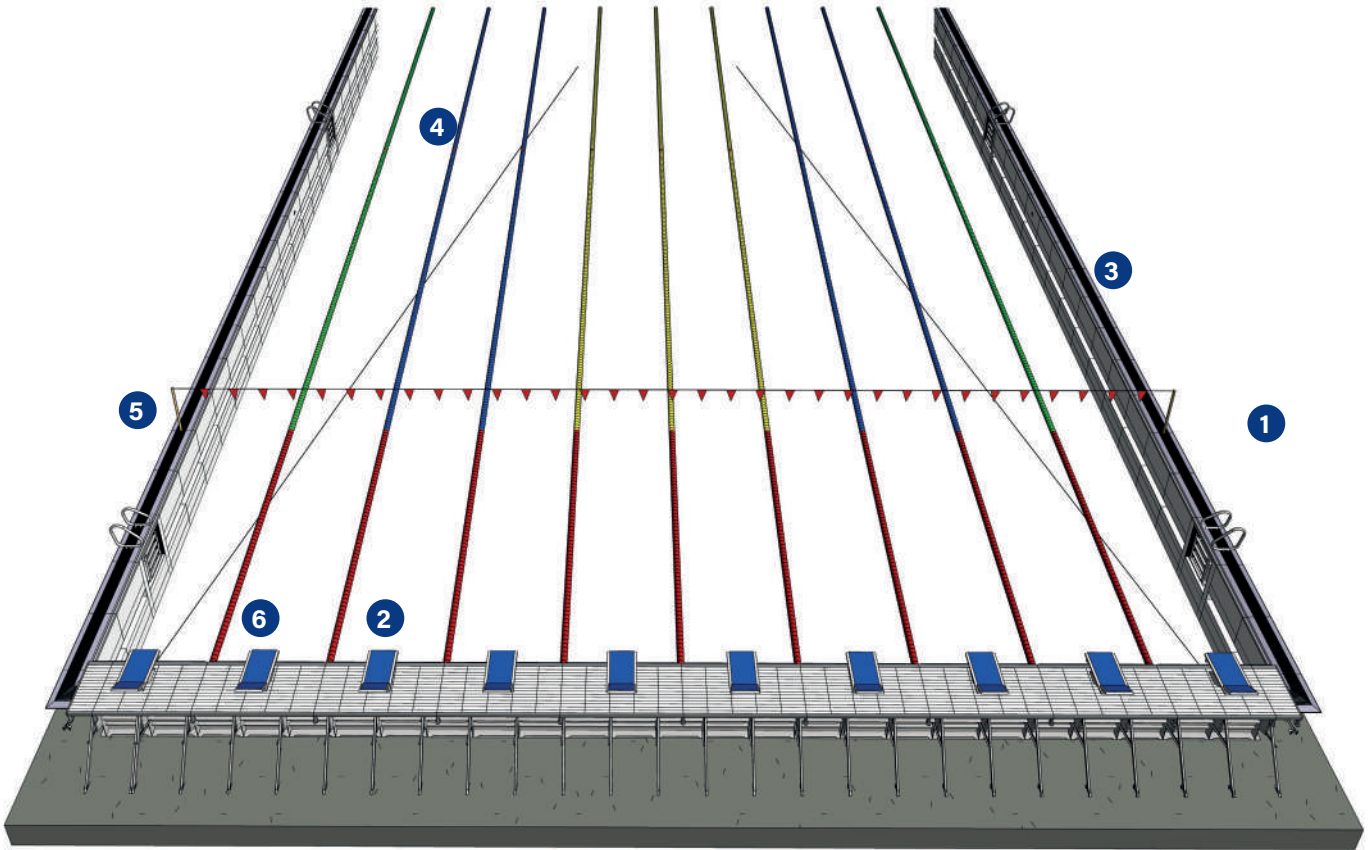

- | | |
|-----------------------------|-------------------------------|
| ① Ladder | ④ Float lines |
| ② Starting block | ⑤ Backstroke flags |
| ③ Grating for pool overflow | ⑥ Turning panel with supports |

Starting block



DESCRIPTION

Specially designed for competition events. Available with adjustable footrest to facilitate entry into the water. Its minimalist design in high quality materials gives it an elegant and modern look.

Manufactured in AISI-316 stainless steel. Polished surface finish. Adjustable support (6 positions). Fastening 54460 not included in supply.

	Code	Standard Pack	Standard weight in kg	Standard volume in m ³
Starting block	53875	1	-	-

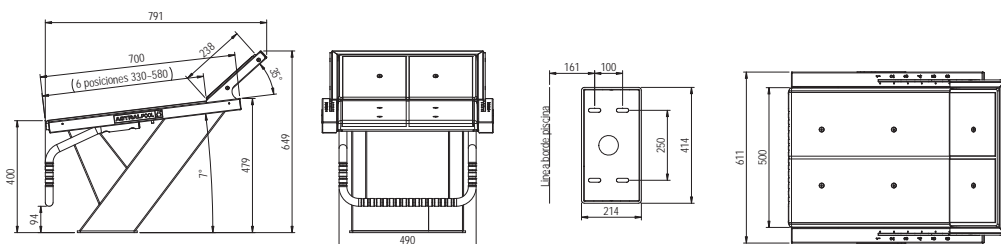

Starting block H-700

mobile support



DESCRIPTION

Specially designed for competition FINA compliant and UNE EN 13451-4. It has adjustable support of 6 positions to facilitate the exit to the swimmer. Made of AISI-316 stainless steel and with a height of 700 mm to avoid having to install headwall for podiums in the pool. Installation with anchor 73971 not included in supply.

	Code	Standard Pack	Standard weight in kg	Standard volume in m ³
Starting block, height 700 mm	74011	1	110	-

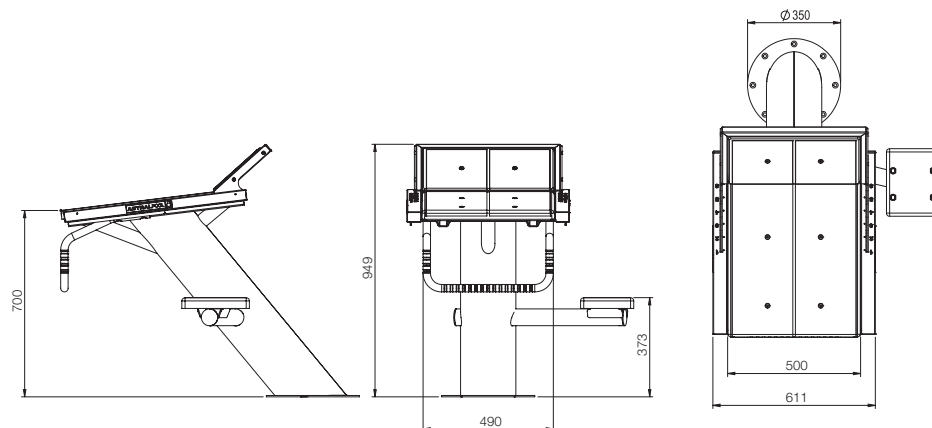

Starting block H-700 anchorage



DESCRIPTION

Anchor designed for the H-700 podium with support, code 74011, to be embedded in concrete. Made in Stainless Steel AISI-316L.

	Code	Standard Pack	Standard weight in kg	Standard volume in m ³
Anchor	73971	1	8.42	-

Starting blocks



DESCRIPTION

Base in S.S. AISI-316. Adjustable platform in polyester & fibreglass with non-slip finish 500 mm x 500 mm. Number sequence not included. Plate anchoring for starting block in AISI-316 code 54461 not included.

	Code	Standard Pack	Standard weight in kg	Standard volume in m ³
POLISHED FINISH:				
Height 700 mm	00144	1	32.0	0.36
Height 400 mm	00145	1	25.3	0.18

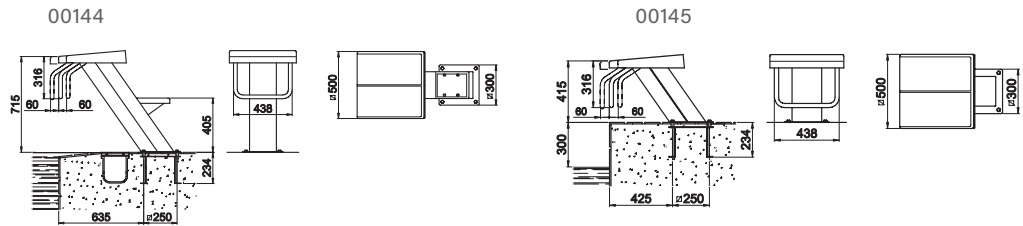

Starting blocks

DESCRIPTION

Made in S.S. AISI-304. Platform in Polyester and fibreglass with non-slip finish 500 mm x 500 mm. Number sequence not included.

	Code	Standard Pack	Standard weight in kg	Standard volume in m ³
POLISHED FINISH:				
Height 700 mm	00146	1	25.0	0.48
Height 400 mm	27578	1	18.0	0.11

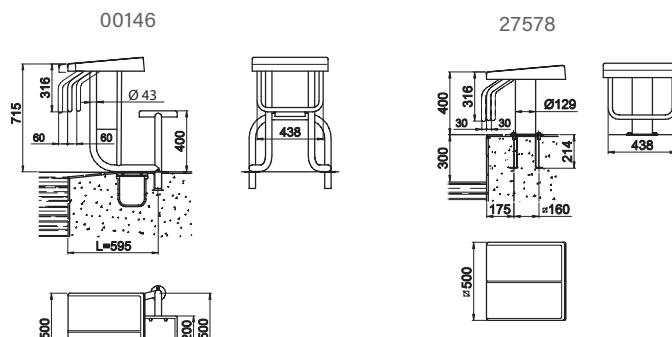

Note: The starting block with code number 00146 may be made to order to adapt to the position of the overflow channels. In such cases, the measurement for L must be provided.

Notes:

Code 00146: Fastener (code 00143), not included.

Code 27578: Fastener (code 54462), not included.

Headwall for podiums



DESCRIPTION

AstralPool has created a headwall that allows starting blocks to be attached. This addition extends our range of products for competition. The item consists of an AISI-304 Stainless Steel structure and plastic grating. The platform can also be used as a turning panel and includes anchors for float lines.

	Code	Standard Pack	Standard weight in kg	Standard volume in m ³
Headwall, lane width 2 m	34213	1	-	-
Headwall, lane width 2.5 m	34214	1	-	-
Headwall, right corner	34215	1	-	-
Headwall, left corner	34216	1	-	-

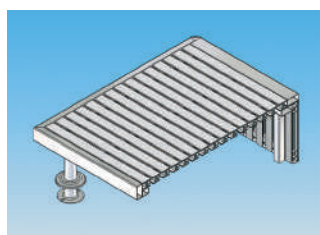

34216

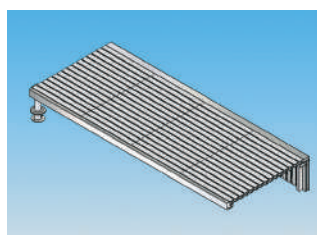

34213 - 2 m
34214 - 2.5 m

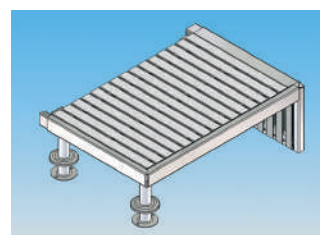

34215

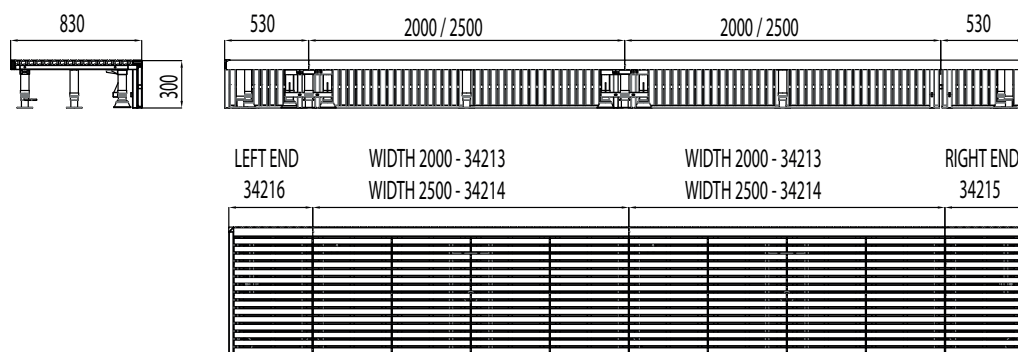

Podium fixing

DESCRIPTION

Anchoring for installation of the podiums in concrete, made in Stainless Steel AISI-304/316, composed by inground base, bolts and washers, with connection to the equipotential circuit.

	Code	Standard Pack	Standard weight in kg	Standard volume in m ³
Made in AISI-316				
Competition podium fixing	54460	1	2.4	0.02
Fixing for the podium	54461	1	3.5	0.02
Made in AISI-304				
Fixing for the podium	54462	1	2.4	0.02

Fastening 54460: For podiums codes 28760 - 28761 - 53875

Fastening 54461: For podiums codes 00144 - 00145 - 19956

Fastening 54462: For podium code 27578

Starting blocks numbers



Height
80 mm

Height
100 mm

DESCRIPTION

4 units of each supplied.

	Code	Standard Pack	Standard weight in kg	Standard volume in m ³
Height 80 mm				
(For starting blocks 00146 - 27578 - 27836)				
For starting blocks from 1 to 6	28616	1	-	-
For starting blocks from 1 to 10	28617	1	-	-
Height 100 mm				
(For starting blocks 00144 - 00145 - 19956 -- 28760 - 28761 - 53875)				
For starting blocks BCN03 from 1 to 6	34200	1	0.1	0.001
For starting blocks BCN03 from 1 to 10	34201	1	0.1	0.001



It is possible to supply any length, colour combination and rope.

BCN03 Competition lane rope model

DESCRIPTION

Lane ropes supplied assembled with floats, 6 mm stainless steel rope (code 28808), tightener (00208) and spring (01468). Floats with interior turbines with an external Ø of 148 mm in accordance with FINA international swimming federation regulations.

	Code	Standard Pack	Standard weight in kg	Standard volume in m ³
25 m				
Red - White colour	67599	1	-	-
Red - Green colour	67601	1	-	-
Red - Blue colour	67602	1	-	-
Red - Yellow colour	67603	1	-	-
50 m				
Red - White colour	67600	1	-	-
Red - Green colour	67604	1	-	-
Red - Blue colour	67605	1	-	-
Red - Yellow colour	67606	1	-	-

Sydney model



It is possible to supply any length, colour combination and rope.

DESCRIPTION

Range comprising lane ropes with an external Ø of 148 mm in accordance with FINA international swimming federation regulation FR 3 for pools for Olympic Games or world championships. Supplied assembled with floats, 6 mm stainless steel rope (code 28808), tightener (00208) and spring (01468).

	Code	Standard Pack	Standard weight in kg	Standard volume in m ³
12,5 m*				
White colour	67607	1	-	-
16.5 m White colour				
White colour	67608	1	-	-
25 m				
Red - White colour	67609	1	-	-
Red - Green colour	67612	1	-	-
Red - Blue colour	67613	1	-	-
Red - Yellow colour	67614	1	-	-
33 m³/h				
Red - White colour	67610	1	-	-
50 m				
Red - White colour	67611	1	-	-
Red - Green colour	67615	1	-	-
Red - Blue colour	67616	1	-	-
Red - Yellow colour	67617	1	-	-

* Available in other colours (blue, green, yellow)

Roma model



DESCRIPTION

Supplied assembled with floats, 7 mm polyester rope (code 00210), tightener (00209) and hook (00207).

	Code	Standard Pack	Standard weight in kg	Standard volume in m ³
12.5 m White colour	67618	1	-	-
16.5 m White colour	67619	1	-	-
25 m Orange - White	67620	1	-	-
33 m Orange - White	67621	1	-	-
50 m Orange - White	67622	1	-	-

* Available in other colours (Blue, Green, Red)

Moscow model



DESCRIPTION

Supplied assembled with floats, 7 mm polyester rope (code 00210), tightener (00209) and hook (00207).

	Code	Standard Pack	Standard weight in kg	Standard volume in m ³
12.5 m White colour	67623	1	-	-
16.5 m White colour	67624	1	-	-
25 m Orange - White	67625	1	-	-
33 m Orange - White	67626	1	-	-
50 m Orange - White	67627	1	-	-

* Available in other colours (Blue, Green, Red)

FLOATS

BCN03 model



DESCRIPTION

Supplied with inner turbine mechanism.

	Code	Standard Pack	Standard weight in kg	Standard volume in m ³
Colour				
White	28204	-	-	-
Green	28425	-	-	-
Blue	28423	-	-	-
Red	28424	-	-	-

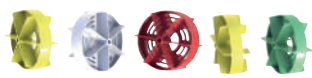

Sydney model

	Code	Standard Pack	Standard weight in kg	Standard volume in m ³
Colour				
White	54032	-	-	-
Yellow	54031	-	-	-
Blue	54028	-	-	-
Red	54029	-	-	-
Green	54030	-	-	-

Moscow model



	Code	Standard Pack	Standard weight in kg	Standard volume in m ³
Moscow propeller:				
Colour				
White	00161	150	7.0	0.070
Orange	00162	150	7.0	0.070
Blue	00163	150	7.0	0.070
Red	00164	150	7.0	0.070
Rome floaters:				
Colour				
White	00149	500	7.0	0.110
Orange	00150	500	7.0	0.110
Blue	00151	500	7.0	0.110
Red	00152	500	7.0	0.110

BCN03 Lane rope storage basket



DESCRIPTION

A new trolley designed to transport and store the BCN03 Lane ropes after use in the swimming pool. The BCN03 lane rope storage basket is manufactured of AISI-316 Stainless Steel and includes a PVC bag for collecting excess water from the float lines. Due to the bag's bottom outlets, it is emptied in a controlled manner with no water spillage. The trolley has four castor wheels for maximum mobility. Two of these fitted with brakes. It can store a lane rope up to 50 m long (or 2 of 25) and can be used for all lane rope models.

Code	Standard Pack	Standard weight in kg	Standard volume in m ³
28623	1	55.0	0.389

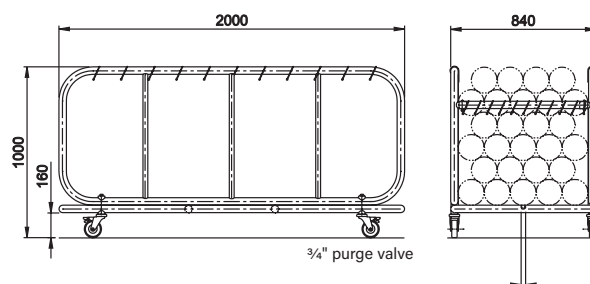

Lane rope roller

DESCRIPTION

Made in Stainless Steel AISI-304, fitted with a large wheel for operation. It is mounted on 4 castor wheels for easy handling. Two of these are fitted with brakes.

	Code	Standard Pack	Standard weight in kg	Standard volume in m ³
Width 1.2 m	58860	1	27	0.31
Width 1.8 m	58859	1	32	0.45

NUMBER OF LANE ROPES COLLECTED

Model	1.2 m			1.8 m		
	25 m	33 m	50 m	25 m	33 m	50 m
ROMA	8	6	4	12	9	6
SIDNEY	2	1	1	3	2	1
MOSCOW	4	2	2	6	3	3

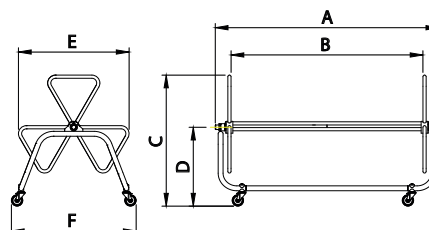

TECHNICAL FEATURES

Code	A	B	C	D	E	F
58860	1415	1125	1165	690	970	1085
58859	2015	1725				

Under deck lane rope storage system



DESCRIPTION

Made of AISI-316, allows the storage of the float lines beneath the deck. The float line box is embedded in the pool surround and holds the retractable reel over which the float line slides into the hole. This unit can be complemented with a lane rope collecting bag if required.

Code	Standard Pack	Standard weight in kg	Standard volume in m ³
15842	1	12.8	0.08

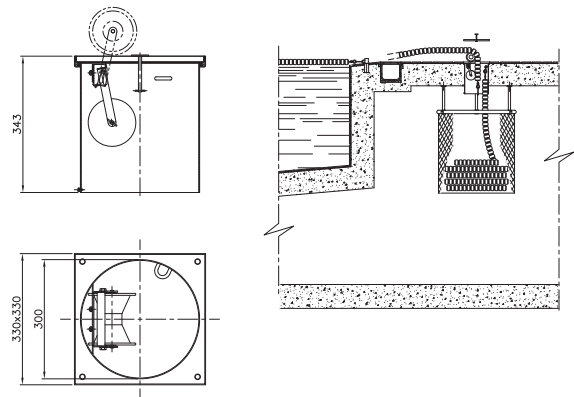

Zurich/Wiesbaden type installation diagram

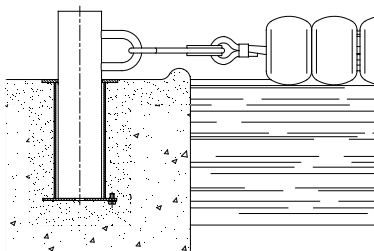

Anchor Lane rope support code 00141
code 00140

Finnish type installation diagram

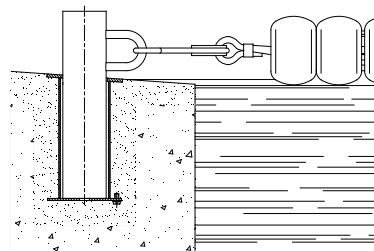

Anchor Lane rope support code 00142
code 00140

Standard type Installation diagram

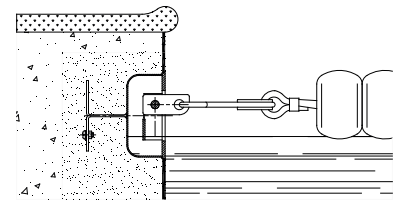

Anchoring cup code 09206
code 09207
code 00205
code 00206

Lane rope anchor



DESCRIPTION

Made in AISI-316 stainless steel. To use with anchoring fixture 00141 and 00142.

Code	Standard Pack	Standard weight in kg	Standard volume in m ³
00140	2	0.63	0.003

Concrete anchoring cup with central rod

DESCRIPTION

Made in AISI-316 stainless steel.

Code	Standard Pack	Standard weight in kg	Standard volume in m ³	
For concrete pool	09206	1	0.4	0.001

Concrete anchoring cup with central rod



DESCRIPTION

Made in AISI-316 stainless steel.

	Code	Standard Pack	Standard weight in kg	Standard volume in m ³
For prefabricated pools with flange, gasket and screws	09207	1	0.5	0.001

Retractable anchoring cup



DESCRIPTION

Made in AISI-316 stainless steel.

	Code	Standard Pack	Standard weight in kg	Standard volume in m ³
For concrete pool with a retractable hook	00205	1	0.46	0.001

Retractable anchoring cup



DESCRIPTION

Made in AISI-316 stainless steel.

	Code	Standard Pack	Standard weight in kg	Standard volume in m ³
For prefabricated pools with retractable hook, flange, gaskets and screws	00206	1	0.6	0.001

Lane rope ratchet



DESCRIPTION

Chrome plated brass.

	Code	Standard Pack	Standard weight in kg	Standard volume in m ³
	00208	1	0.97	0.002

Lane rope ratchet



DESCRIPTION

AISI-316 stainless steel.

	Code	Standard Pack	Standard weight in kg	Standard volume in m ³
	00209	1	0.2	0.001

Lane rope spring



DESCRIPTION

AISI-204 stainless steel with cable fastener.

	Code	Standard Pack	Standard weight in kg	Standard volume in m ³
	01468	1	0.62	0.002

Lane rope hook



DESCRIPTION

Stainless Steel AISI-304.

	Code	Standard Pack	Standard weight in kg	Standard volume in m ³
	00207	100	5	0.01

Cords and cables



	Code	Standard Pack	Standard weight in kg	Standard volume in m ³
Ø 7 mm polyester rope	00210	110 m	2.0	0.090
AISI-316 stainless steel cable				
Ø 4 x 6 mm with plastic coating DIN 3055	00211	-	0.1	0.001
BCN03 AISI-316 Stainless Steel cable				
Ø 6 mm without plastic coating	28808	-	-	-

SIGNAGE

False start indicators

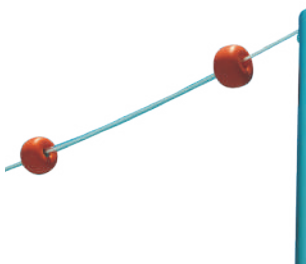

DESCRIPTION

Please indicate pool width when placing your order.

Comprises 2 posts in AISI-316 S.S. (one with pulley and quick release cord). Height 1.8 m. Anchoring socket not included.

	Code	Standard Pack	Standard weight in kg	Standard volume in m ³
False start posts:				
- Pool width up to 21 m Ø 43 mm pipe for use with anchoring sockets 00141 and 00142	19950	1	5.6	0.01
- Pool width over 21 m Ø 48 mm pipe for use with anchoring sockets 19960 and 19961	19951	1	9.4	0.01
False start floats:				
Polyester cord and floats	19954	1	-	-

NOTE:

You must state the pool dimensions and depths on placing your order.

Backstroke turn indicators



NOTE:

You must state the pool dimensions and depths on placing your order.

DESCRIPTION

Please indicate pool width when placing your order.
Comprises 4 posts in AISI-316 stainless steel. Height 1.8 m. Anchoring sockets not included.

	Code	Standard Pack	Standard weight in kg	Standard volume in m ³
Backstroke turn indicator posts				
- Pool width up to 21 m Ø 43 mm pipe for use with anchoring sockets 00141 and 00142	19952	1	11.2	0.03
- Pool width over 21 m Ø 48 mm pipe for use with anchoring sockets 19960 and 19961	19953	1	20.0	0.03
Backstroke turn indicator bunting				
2 units	19955	1	-	-

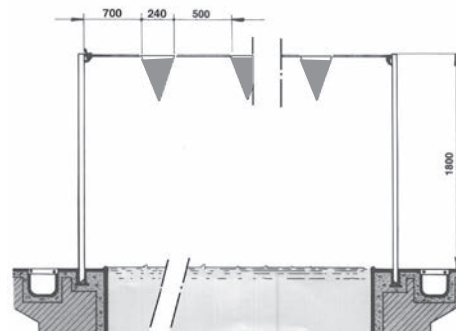
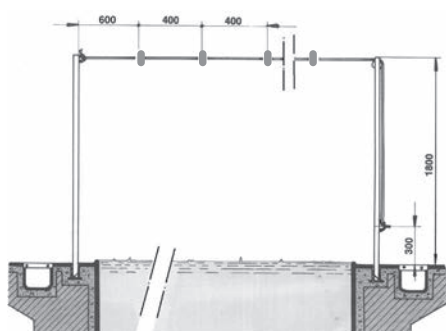

TURNING PANELS

Turning panels

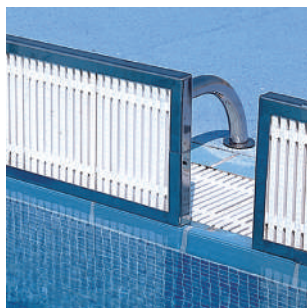

NOTE:

You must state the pool dimensions and depths on placing your order.

DESCRIPTION

In AISI-316 stainless steel with plastic lattice screen. Height 300 mm. Fixing support (00139) is not included

	Code	Standard Pack	Standard weight in kg	Standard volume in m ³
Lane width 2 m	00137	1	13.6	0.040
Lane width 2.5 m	00138	1	16.5	0.051

TURNING PANELS

Bracket

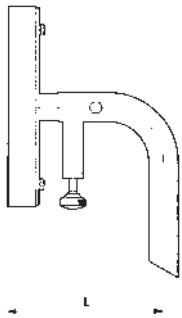

DESCRIPTION

AISI-316 stainless steel (for coupling to 00141 and 00142 fasteners). State H and L dimensions and type of overflow channel when placing an order. A minimum of two units are required for each rotating panel.

	Code	Standard Pack	Standard weight in kg	Standard volume in m ³
	00139	1	4.0	0.054

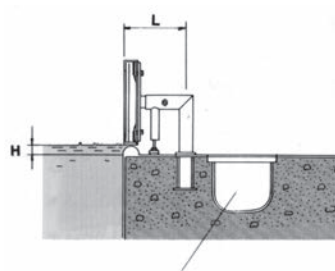

ANCHORING DETAILS WHEN MEASUREMENT «L» IS LESS THAN 500 mm.

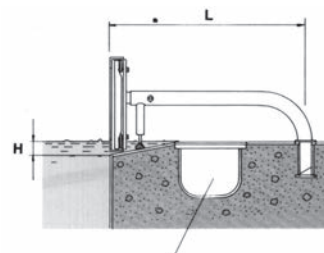
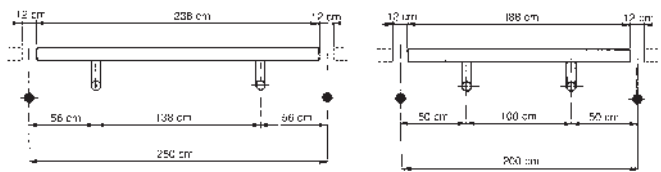

ANCHORING DETAILS WHEN MEASUREMENT «L» IS OVER 500 mm.

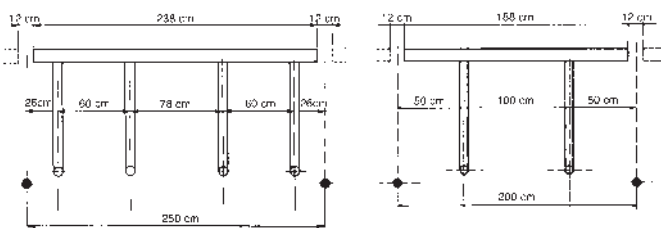

ATTACHMENTS FOR COMPETITION EQUIPMENT

Horizontal flange anchoring sockets



DESCRIPTION

Zurich-Wiesbaden. In S.S. AISI-316.

	Code	Standard Pack	Standard weight in kg	Standard volume in m ³
For Ø 43 mm pipe	00141	2	1.17	0.002
For Ø 48 mm pipe	19960	2	1.3	0.002

Angled flange anchoring socket



DESCRIPTION

Finnish. In S.S. AISI-316.

	Code	Standard Pack	Standard weight in kg	Standard volume in m ³
For Ø 43 mm pipe	00142	2	1.13	0.002
For Ø 48 mm pipe	19961	2	1.26	0.002

Anchoring socket with locking bolts



DESCRIPTION

With bolts. In S.S. AISI-316.

	Code	Standard Pack	Standard weight in kg	Standard volume in m ³
	00143	2	1.47	0.003

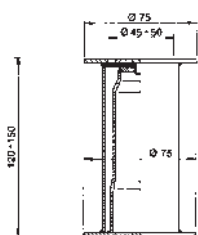

Code 00141
Code 19960

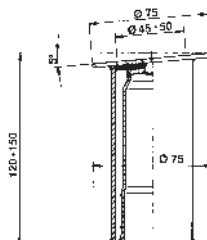

Code 00142
Code 19961

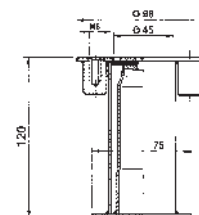

Code 00143

WATER POLO GOAL

Water polo goal



DESCRIPTION

The water polo goal is lightweight, floating and very resistant. It is built entirely from aluminium and is oven-painted white.

Manufacturing and measurements in accordance with FINA international swimming federation standards.

- Floating: Polyurethane foam-filled aluminium floats.
- Goal frame: 80 x 50mm aluminium tube
- Net fastening: 6 mm stainless steel round rod.
- Net side pipe: 23 mm stainless steel round pipe with fastening in frame and float.
- Fastening for goal lines.
- Nets included.

	Code	Standard Pack	Standard weight in kg	Standard volume in m ³
Official water polo goal kit	69654	1	-	-

Inú Wellness Centre (Andorra)
Architect: Jean-Michel Ruols

WELLNESS SOLUTIONS

FLUIDRA

ASTRALPOOL 

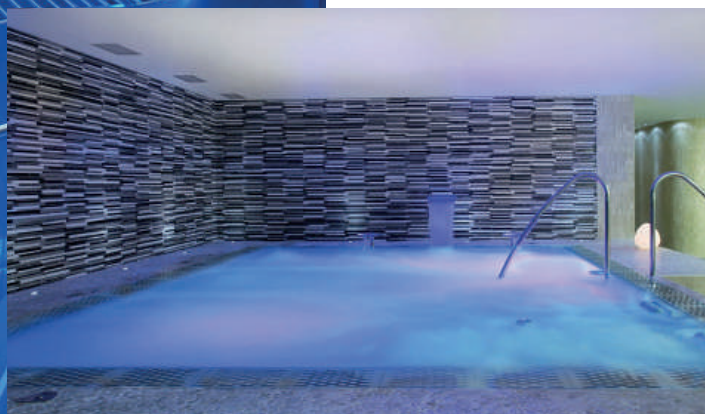
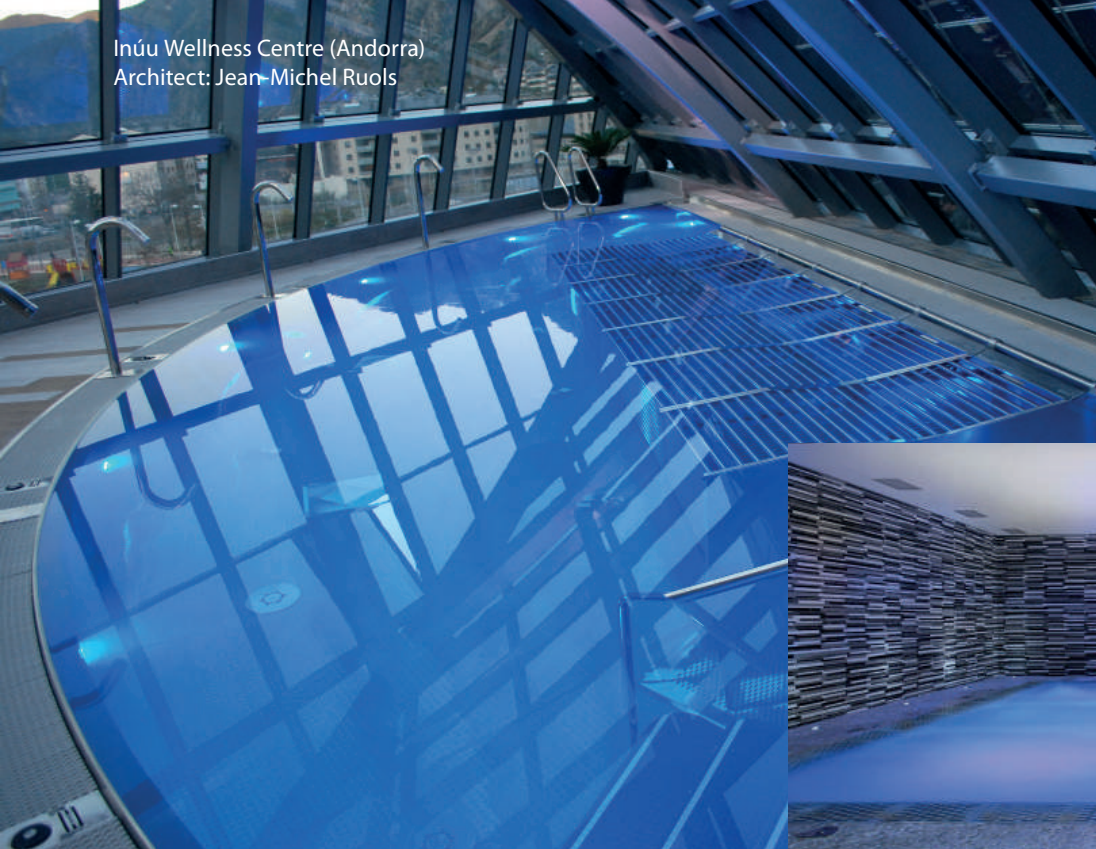

Only Fluidra, with more than 40 years' experience and operations worldwide, could become the new leader in the manufacture of stainless steel swimming pools, with its brand INOX POOL.

Much more than swimming pools, their high quality and beauty will leave you with unforgettable memories. Turnkey solutions are available both for residential and public pools (hotels, sports clubs, spas...).

Advantages of an INOX POOL:

- **Durable.** They last a lifetime.
- **Watertight.** They never leak or lose water.
- **Adaptable.** We will design the pool of your dreams, whatever your specifications.
- **Clean.** Dirt does not stick to them.
- **Sustainable.** The stainless steel is fully recyclable.
- **Elegant.** They have unique finishes.

Place your trust in **INOX POOL**. We will create **the pool of your life built to last a lifetime**. **WARRANTY OF UP TO 20 YEARS.**

**Customized, integrated solutions adapted
to your needs and to your imagination.
Hypnotic pools.**



Ask for your new **Wellness** catalogue by AstralPool

SPA & POOL INOX SOLUTION

E X C L U S I V E I T Y

INTEGRAL SOLUTIONS, UNIQUE DESIGNS AND CUSTOM SOLUTIONS DEVELOPED CREATE EXCLUSIVE SPACES IN A WELLNESS ENVIRONMENT.

We put at your disposal all the tools and our broad experience to turn your project into reality, adapting our designs to the client's needs. Personalised projects.

Our flexibility and dynamism, as well as our adaptation to the needs and regulations of each market, have led us to build steel solutions in more than 60 countries, making us one of the companies with the greatest international outreach in the sector.

STAINLESS STEEL CRAFTSMEN



ASTRALPOOL 

FLUIDRA





COMMERCIAL POOLS

FOUNTAINS



820 FOUNTAIN JET NOZZLES

- 820 Spear nozzle
- 820 Cascade swivel nozzle
- 820 Foamy nozzle
- 821 TFE nozzle
- 821 Vulcano nozzle
- 821 Flor de Lis
- 822 Bouquet nozzle
- 822 Mushroom nozzle

823 SPECIAL JETS

- 823 Glassy jet
- 823 Glassy jet with jumping effect
- 823 Rocket jet
- 824 Switch S System
- 824 Switch L System + Niche

825 FOUNTAIN PUMPS

- 825 DMX pump S
- 825 DMX pump L
- 825 Submersible pump DF with prefilter

826 LIGHTING

- 826 Directional projector Mini
- 826 Circular Ø200
- 826 Circular Ø300

827 COMPLEMENTARY PRODUCTS

- 827 Junction boxes
- 827 Cable inlet fittings
- 827 Cable inlet fitting boxes
- 828 Swivel
- 828 Waterproof junction

Spear nozzle



DESCRIPTION

Spear Nozzle is the most polyvalent nozzle for the design of any ornamental fountain.

They are made of AISI-304 stainless steel, which provides high sturdiness and rusting resistance, and provides a stylish finish to the fountain.

It has an 20° adjustable joint to correct the jet outlet in case of misalignment of manifolds or pipes, or to create parabolas without additional accessories.

Jet Ø (A)	Inlet	Code	Standard Pack	Standard weight in kg	Standard volume in m ³
Spear Nozzle					
Ø 4 mm	G 3/8" M	67496	25	0.045	0.0027
Ø 6 mm	G 3/8" M	66639	25	0.043	0.0027
Ø 8 mm	G 1/2" M	66640	15	0.085	0.0027
Ø 10 mm	G 1/2" M	66641	15	0.08	0.0027
Ø 12 mm	G 1" M	66642	1	0.315	0.0008
Ø 14 mm	G 1" M	66643	1	0.295	0.0008
Ø 16 mm	G 1 1/2" M	66644	1	0.845	0.0027
Ø 20 mm	G 1 1/2" M	66645	1	0.795	0.0027



Cascade swivel nozzle

DESCRIPTION

Cascade nozzle is a jet that mixes water and air creating a solid and conic column of water visible from any direction. Furthermore, it contributes to oxygen enrichment of the water.

Those nozzles are water level depending, so must be installed on a determinate height. Strong waves can cause changes in the height of the jet.

They are entirely made of AISI 316 stainless steel, which provides high sturdiness and oxidation resistance, and provides a stylish finish at the fountain.

They also incorporate a swivel on its base in order to take up inlet inclinations.

Jet Ø (A)	Inlet	Water level in mm	Code	Standard Pack	Standard weight in kg	Standard volume in m ³
Cascade swivel nozzle						
Ø 35 mm	G 1/2" F	20	73792	1	0.5	0.0027
Ø 50 mm	G 1" F	25	73793	1	0.7	0.0027
Ø 80 mm	G 1 1/2" F	30	73794	1	2.1	0.0115
Ø 100 mm	G 2" F	35	73795	1	3.9	0.0185
Ø 125 mm	G 2 1/2" F	40	73796	1	5.1	0.0271

Foamy nozzle



66689

66690



71335

DESCRIPTION

Foamy Nozzle produces a very sparkling and consistent jet. The ornamental effect doesn't depend on the water level and it's very wind resistant, generating a great uniformity on the fountain.

Furthermore, it contributes to an oxygen enrichment of the water.

There are available two models made entirely of AISI-316 stainless steel, which provides high sturdiness and rusting resistance, and provides a stylish finish at the fountain. For the 35mm model, a stainless steel model and plastic interior is available.

Jet Ø (A)	Inlet	Code	Standard Pack	Standard weight in kg	Standard volume in m ³
Foamy nozzle					
Ø 35 mm	G 1" M	66689	1	0.79	0.0021
Ø 50 mm	G 1" M	66690	1	1.1	0.0027
Ø 32 mm	G 1" M	71335	1	0.45	0.0021

FOUNTAIN JET NOZZLES

TFE nozzle



DESCRIPTION

TFE nozzle produces a sparkling and consistent jet with less flow requirements to similar nozzles with the same diameter. The ornamental effect doesn't depend on the water level and it is very wind resistant, generating a great uniformity on the fountain.

It is made entirely of AISI 316 stainless steel, which provides high sturdiness and rusting resistance, and provides a stylish finish at the fountain.

Jet Ø (A)	Inlet	Code	Standard Pack	Standard weight in kg	Standard volume in m ³
TFE nozzle					
Ø 25 mm	G 1" M	72475	1	0.5	0.0027
Ø 32 mm	G 1 1/4" M	72476	1	0.65	0.0027
Ø 40 mm	G 1 1/2" M	72477	1	0.98	0.0033

Vulcano nozzle



DESCRIPTION

Vulcano nozzle produces a set of parabolic jets reaching different heights and lengths, achieving a nice and visible water effect.

They are entirely made of AISI 316 stainless steel, which provides high sturdiness and oxidation resistance, and provides a stylish finish at the fountain.

Jet Ø (A)	Dimensions	Code	Standard Pack	Standard weight in kg	Standard volume in m ³
Vulcano nozzle					
Ø 1x6 mm + 20x3 mm	80 x 70 mm	67204	1	0.59	0.0011

Flor de Lis



DESCRIPTION

Fleur de lis nozzle produces a set of parabolic regulable jets, reaching different heights and lengths, achieving a nice and visible water effect.

It is entirely made of AISI316 stainless steel, which provides high sturdiness and oxidation resistance, and provides a stylish finish at the fountain.

Water Connection in mm	Dimensions A x B in mm	Code	Standard Pack	Standard weight in kg	Standard volume in m ³
Flor de Lis					
1 1/2" M	190 x 168	73810	1	3.53	0.0077
2" M	190 x 219	73811	1	4.85	0.0115
2 1/2" M	221 x 254	73812	1	7.4	0.0225
3" M	200 x 254	73813	1	7.22	0.0225
4" M	255 x 390	73814	1	18.98	0.0448

Nozzles 73810 and 73811: 1x10mm + 6x6mm + 12x6mm.

Nozzles 73812: 1x12mm + 6x8mm + 12x8mm.

Nozzles 73813: 1x10mm + 12x6mm + 24x6mm.

Nozzles 73814: 1x14mm + 6x12mm + 12x12mm.

Bouquet nozzle



DESCRIPTION

Bouquet nozzle produces a set of parabolic regulable jets, reaching different lengths, achieving a nice and visible water effect.

It is entirely made of AISI316 stainless steel, which provides high sturdiness and oxidation resistance, and provides a stylish finish at the fountain.

Water Connection in mm	Dimensions A x B in mm	Code	Standard Pack	Standard weight in kg	Standard volume in m ³
Bouquet nozzle					
1 1/4" M	190 x 129	73815	1	2.11	0.0077
2" M	190 x 204	73816	1	4.43	0.0077
3" M	220 x 254	73817	1	6.2	0.0225
3" M	220 x 254	73818	1	7	0.0225

Nozzles 73815: 1x8mm + 9x6mm.

Nozzles 73816: 1x8mm + 24x4mm.

Nozzles 73817: 1x14mm + 12x10mm.

Nozzles 73818: 1x14mm + 24x10mm.

Mushroom nozzle



DESCRIPTION

Mushroom nozzle produces a perfectly laminar and semi-spherical transparent lamina. When falling it creates a completely continuous bell-shaped effect.

They are entirely made of AISI 316 stainless steel, which provides high sturdiness and oxidation resistance, and provides a stylish finish at the fountain.

Dimensions	Inlet	Code	Standard Pack	Standard weight in kg	Standard volume in m ³
Mushroom nozzle					
300x80 mm	G 1" F	67206	1	1.15	0.0055

SPECIAL JETS

Glassy jet



DESCRIPTION

Parabolic laminar nozzle that does not spill a single drop of water. From start to finish, a perfect parabolic path is followed that is created on the basis of the laws of fluid dynamics.

The Glassy jet shines light in the water as it follows its path. It only illuminates the water and does not cause any light pollution.

It is made of AISI 316 stainless steel to ensure maximum resistance to rust and to give it a high quality finish.

Light type	Dimensions L x W x H in mm	Voltage in V	Code	Standard Pack	Standard weight in kg	Standard volume in m ³
Glassy jet						
RGB - DMX	306 x 234 x 384	24 VDC	66559	1	6.41	0.0448
RGB	306 x 214 x 384	12 VAC	66559RGB	1	6.41	0.0448
RGB - DMX	447 x 336 x 563	24 VAC	66561	1	24.1	0.0494

Glassy jet with jumping effect



DESCRIPTION

Parabolic laminar nozzle that does not spill a single drop of water. From start to finish, a perfect parabolic path is followed that is created on the basis of the laws of fluid dynamics.

The Glassy jet shines light in the water as it follows its path. It only illuminates the water and does not cause any light pollution.

There is also the Jumping effect option, which throws small streams of water across the parabolic path.

It is made of AISI 316 stainless steel to ensure maximum resistance to rust and to give it a high quality finish.

Light type	Dimensions L x W x H in mm	Voltage in V	Code	Standard Pack	Standard weight in kg	Standard volume in m ³
Glassy jet with jumping effect						
RGB - DMX	358 x 234 x 475	24 VDC	66560	1	11.96	0.0271
RGB - DMX	524 x 336 x 696	24 VDC	66562	1	28.8	0.2366

Rocket jet



DESCRIPTION

The Rocket jet gives the effect of an explosion of water from the ground that rises up in a split second to above the height of really tall buildings as it can reach heights of up to 50 meters.

The explosion of water creates a perfect vertical line that will be the center of attention anywhere.

The lighting highlights the height of the water to turn it into a powerful beam of light, which rises at high speeds and draws colored lines on the water.

The combination of several units of this effect will create spectacular high speed sequences.

Jet height in m	Dimensions L x W x H in mm	Water level in mm	Code	Standard Pack	Standard weight in kg	Standard volume in m ³
Rocket jet						
15	358 x 248 x 727	620	66564	1	18.2	0.1695
30	530 x 515 x 887	720	66565	1	58.1	0.3628
50	642 x 514 x 1558	1320	66566	1	70	0.8008
Rocket jet horizontal						
20	1350 x 305 x 630	570	66563	1	25	0.3189

Switch S System



Please ask us about the characteristics of the different models

DESCRIPTION

Switch System is a dynamic jet ideal for interactive fountains such as Funsquare type, to produce fast water games with individual control for each installed jet.

The design of this jet allows state changes without water hammer in the installation.

It has many tile models being able to choose between different types of round and square designs.

- Dimensions (mm): 300 x 300 x 371 / D.400 x 371.
- Voltage: 24 VDC.
- Power (without LED): 25 W.

	Code	Standard Pack	Standard weight in kg	Standard volume in m ³
Switch S System				
Square Cover / 1xNano LED	66569	1	7.5	0.0814
Circular Cover / 1xNano LED	73351	1	7.5	0.0814
Circular Cover / 2xNano LED	73352	1	7.8	0.0814
Circular Cover / 1xMini LED	73353	1	7.8	0.0814
Circular Cover / 2xMini LED	73354	1	8.1	0.0814
Circular Cover / 1xCircular 200 LED I1264	73355	1	8.2	0.0814
Circular Cover / 1xCircular 200 LED I1265	73356	1	8.2	0.0814
Square Cover / 2xNano LED	73357	1	7.8	0.0814
Square Cover / 1xMini LED	73358	1	7.8	0.0814
Square Cover / 2xMini LED	73359	1	8.1	0.0814
Square Cover / 1xCircular 200 LED I1264	73360	1	8.2	0.0814
Square Cover / 1xCircular 200 LED I1265	73361	1	8.2	0.0814



66570



66572

Switch L System + Niche

DESCRIPTION

Switch System is a dynamic jet ideal for interactive fountains such as Funsquare type, to produce fast water games with individual control for each installed jet. The design of this jet allows state changes without water hammer in the installation.

For dry fountains there is the option of the Switch System with 316 stainless steel niche and integrated LED RGB-DMX projectors.

Switch L System

- Dimensions (mm): 210 x 120 x 261.
- Voltage: 24 VDC.
- Power (without LED): 25 W.

Switch L Niche

- Dimensions (mm): 494 x 494 x 500.
- Material: Stainless steel 316.
- Weight (mm): 19 kg.

	Code	Standard Pack	Standard weight in kg	Standard volume in m ³
Switch L System	66570	1	6.6	0.0185
Switch L Niche	66572	1	19	0.1775

FOUNTAIN PUMPS

DMX pump S



DESCRIPTION

The DMX Variable Pump S allows to control the jet heights individually, creating a multitude of effects and figures in dynamic fountains. It is ideal to be installed just below the Spear Nozzle between 12 and 14 mm and Foamy Nozzles.

The device incorporates the height variation system through DMX protocol, what facilitates the control of the jets and reduces considerably the size and cost of electrical cabinets.

- Dimensions (mm): 254 x 97 x 121.
- Voltage: 24 VDC.
- Power: 100 W.

	Code	Standard Pack	Standard weight in kg	Standard volume in m ³
DMX variable pump S	67410	1	3	0.0185

DMX pump L

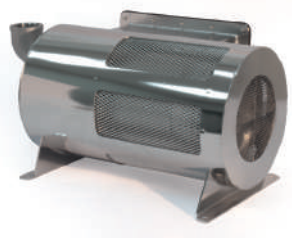

DESCRIPTION

The DMX Variable Pump L allows to control the height of the jets individually, creating a multitude of effects and figures in dynamic fountains. It is ideal to be installed just below the Spear Nozzle between 12-20 mm and Foamy Nozzles.

The device incorporates the height variation system of variation through DMX protocol, what facilitates the control of the jets and reduces considerably the size and cost of the electrical cabinets.

- Dimensions (mm): 500 x 366 x 239.
- Voltage: 220 - 240 VAC.
- Power: 720 W.

	Code	Standard Pack	Standard weight in kg	Standard volume in m ³
DMX variable pump L	67411	1	23	0.1127

Submersible pump DF with prefilter

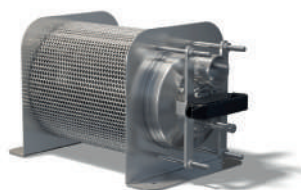

DESCRIPTION

Submersible DF pumps has a prefilter incorporated which helps to the correct working of the device. It has a large filter surface, so increases highly filter clogging time.

Incorporates supports to ease horizontal pump installation.

There are available some pump models according to the needs of each installation.

It is a very robust and resistant to rusting model manufactured in AISI 304 stainless steel.

- Minimum water depth: 300 mm.

Power in W	Voltage in V	Dimensions L x W x H in mm	Code	Standard Pack	Standard weight in kg	Standard volume in m ³
0.55	230 ~3	402 x 232 x 234	70173	1	11.5	0.0342
0.75	230 ~3	417 x 232 x 234	70175	1	11.8	0.0342
1.1	230 ~3	447 x 232 x 234	70177	1	12.1	0.0342
1.5	230 ~3	447 x 232 x 234	70179	1	12.5	0.0342
0.55	400 ~3	402 x 232 x 234	70180	1	11.5	0.0342
0.75	400 ~3	417 x 232 x 234	70181	1	11.8	0.0342
1.1	400 ~3	447 x 232 x 234	70184	1	18	0.0650
1.5	400 ~3	447 x 232 x 234	70190	1	19.4	0.0650

Directional projector Mini



DESCRIPTION

This spotlight is especially designed for fountains, gardens and decorative aquatic installations. It can be installed indiscriminately submerged or outside the water.

It is supplied with screws and studs for fitting.

Possibility of narrow, medium or wide lens.

	Code	Standard Pack	Standard weight in kg	Standard volume in m ³
Directional projector Mini	I0406	-	-	-
Directional projector Mini+	I0411	-	-	-

TECHNICAL FEATURES

	Mini				Mini+			
	Monocolour	Multicolour	MDMX	MWDMX	Monocolour	Multicolour	MDMX	MWDMX
Consumption	4W (6VA)	4W (7VA)	4W (4VA)	5W (5VA)	6W (9VA)	6W (9VA)	6W (6VA)	8W (8VA)
Voltage	12 VAC	12 VAC	24 VAC	24 VAC	12 VAC	12 VAC	24 VAC	24 VAC
Lumens	315 lm	186 lm	186 lm	300 lm	550 lm	250 lm	250 lm	430 lm
Efficiency	78.7 lm/W	46.5 lm/W	46.5 lm/W	60 lm/W	91.66 lm/W	55 lm/W	55 lm/W	53.75 lm/W
Life Span	L80 - 60000h							
Protection level	IP68							

Circular Ø200



DESCRIPTION

Projector designed for fitting directly to the jets of ornamental fountains, thus ensuring that they are properly illuminated and emit an even source of light.

- Consumption: 16 W.
- Voltage: 24 VDC.
- Lumens: 1450 lm (Monocolour) / 1000 lm (MWDMX).
- Efficiency: 91 lm/W (Monocolour) / 62.5 lm/W (MWDMX).
- Life Span: L80 - 60000 h.
- Protection level: IP68.

	Code	Standard Pack	Standard weight in kg	Standard volume in m ³
Circular Ø200 1" ½ fitting	I1261	-	2.9	-
Circular Ø200 1" fitting	I1262	-	2.9	-
Circular Ø200 non threaded fitting	I1263	-	2.9	-
Circular Ø200 flat mounting	I1264	-	3.3	-
Circular Ø200 dry fountain	I1265	-	3.3	-

* Consult mounting accessory.

Circular Ø300



DESCRIPTION

A large projector with high luminous performance for fitting directly to the jets of ornamental fountains of up to 1" ½. Made of stainless steel.

- Consumption: 80 W.
- Voltage: 24 VDC.
- Lumens: 7200 lm (Monocolour) / 4100 lm (MWDMX).
- Efficiency: 90 lm/W (Monocolour) / 51 lm/W (MWDMX).
- Life Span: L80 - 60000 h.
- Protection level: IP68.

	Code	Standard Pack	Standard weight in kg	Standard volume in m ³
Circular Ø300	I1255	-	4.4	-

Junction boxes



DESCRIPTION

The Junction Boxes are the best way to ensure watertight connections between cable inside the pool of the fountain. With its original design allow the connection of different devices with the same Junction Box.

It is a very robust and resistant to oxidation model manufactured entirely in AISI 316 stainless steel.

- Wire diameter: 5-14 mm.
- Protection class: IP 68.

Number of inlets	Dimensions L x W x H in mm	Code	Standard Pack	Standard weight in kg	Standard volume in m ³
6	224 x 190 x 119	66602	1	3	0.0103
10	224 x 240 x 119	66603	1	3.78	0.0103
16	324 x 290 x 119	66604	1	6.15	0.0408
32	324 x 290 x 131	66605	1	6.97	0.0408

Cable inlet fittings



DESCRIPTION

The Cable inlets Fittings are the best way to ensure watertight connections with cable through the walls of the fountain. With its original design allow the connection of different devices with the same Cable Inlet Fitting.

It is a very robust and resistant to oxidation model manufactured entirely in AISI 316 stainless steel.

- Wire diameter: 5-14 mm.
- Protection class: IP 68.

Number of inlets	Connection	Dimensions L x W x H in mm	Code	Standard Pack	Standard weight in kg	Standard volume in m ³
1	1"G	70 x 48 x 122	66598	1	0.25	0.0027
3	2"G	80 x 70 x 122	66599	1	0.52	0.0027
5	3"G	175 x 175 x 152	66600	1	2.55	0.0077
8	4"G	215 x 215 x 152	66601	1	3.65	0.0210

Cable inlet fitting boxes



DESCRIPTION

The Cable inlet Fitting Box are the best way to ensure watertight connections with cable through the walls of the fountain and at the same time interconnect different devices.

It is a very robust and resistant to rusting model manufactured entirely in AISI 316 stainless steel.

- Wire diameter: 5-14 mm.
- Protection class: IP 68.

Number of inlets	Connection	Dimensions L x W x H in mm	Code	Standard Pack	Standard weight in kg	Standard volume in m ³
16	3"G	290 x 290 x 263	66606	1	6.96	0.0408
32	3"G	290 x 290 x 275	66607	1	7.78	0.0408
16	4"G	290 x 290 x 263	66608	1	7.31	0.0408
32	4"G	290 x 290 x 275	66609	1	8.12	0.0408

Swivel



DESCRIPTION

The Swivel is a perfect adapter for all types of nozzles. Corrects the unevenness produced during the development of the work. The Swivel also allows positioning any type of nozzle in any desired angle.

Material	Connection	Dimensions A x B in mm	Code	Standard Pack	Standard weight in kg	Standard volume in m ³
AISI 316	1"G	70 x 68	66930	1	0.635	0.0008
AISI 316	1 1/2"G	93 x 89	66929	1	1.15	0.0021
Nickel plated brass	1"G	49 x 85	73347	1	0.4	0.0008



Waterproof junction

DESCRIPTION

This robust waterproof junction allows to make IP68 connections, both for electrical and communication cables.

It is available in two different models, depending on the cable diameter to be connected.

Both models are made of AISI 316 stainless steel to ensure high protection against rust and weathering.

- Dimensions: 171 x 76 x 76 mm.
- Material: SS 316 / Brass / TPE.
- Protection class: IP 68.

Junction	Cable diameter range in mm	Code	Standard Pack	Standard weight in kg	Standard volume in m ³
D14	14 - 5	70685	1	0.68	0.0027
D20	20 - 11	70684	1	0.69	0.0027

Projects



Great Exhibition of the North – Newcastle, United Kingdom



Kashirskaya – Moscow, Russia



Vadi Istanbul – Istanbul, Turkey



Central Park – Almaty, Kazakhstan

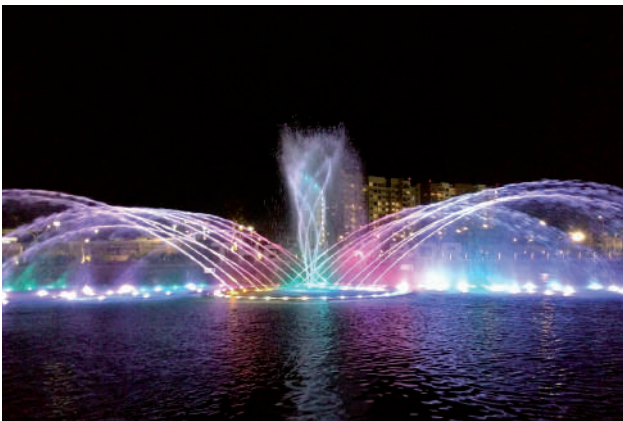

The Harbor Merida – Merida, Mexico



Nazarbaev Street Funsquare – Almaty, Kazakhstan

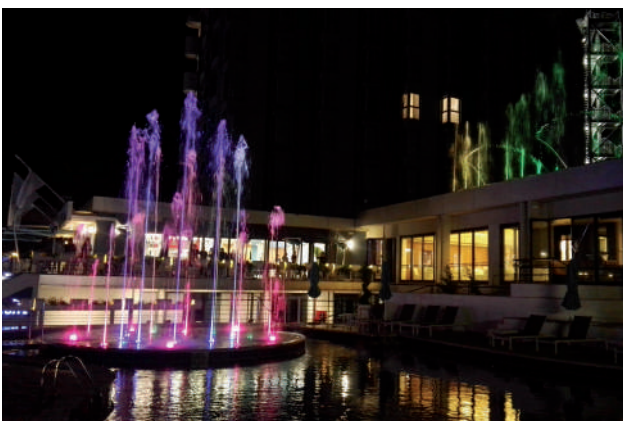

Boscolo Airone Hotel – Venice, Italy



Astana Expo 2017 – Astana, Kazakhstan

Projects



Gravellona Toce – Verbano-Cusio-Ossola, Italy

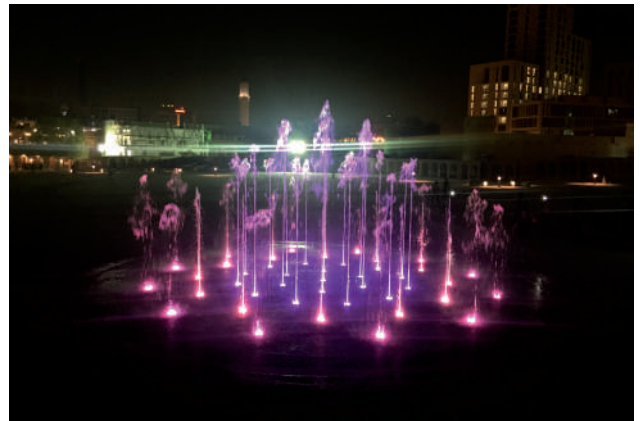

Souq Waqif Funsquare – Doha, Qatar



Mega Silk Way – Astana, Kazakhstan



La Pedrera Park – San Luis, Argentina



Moremall Fountain – Sochi, Russia

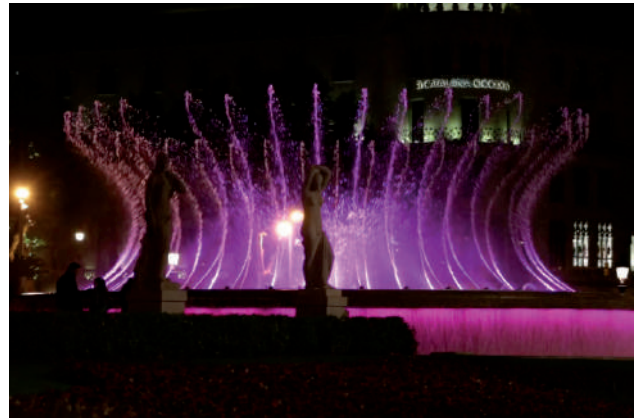

Catalonia Square Fountains – Barcelona, Spain



Timisoara Sunsquare – Timisoara, Romania

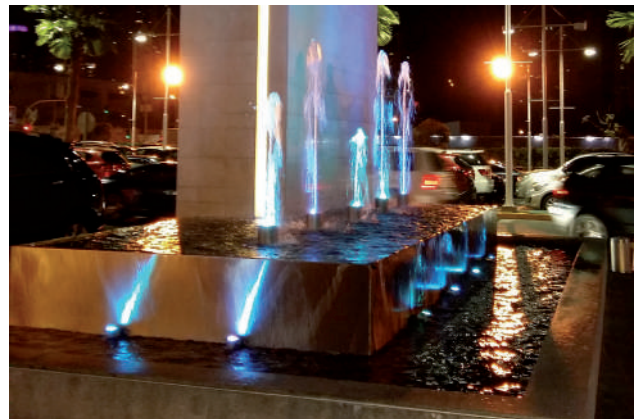

Panama City – Panama

Projects



Taman Anggrek Funsquare – Jakarta, Indonesia

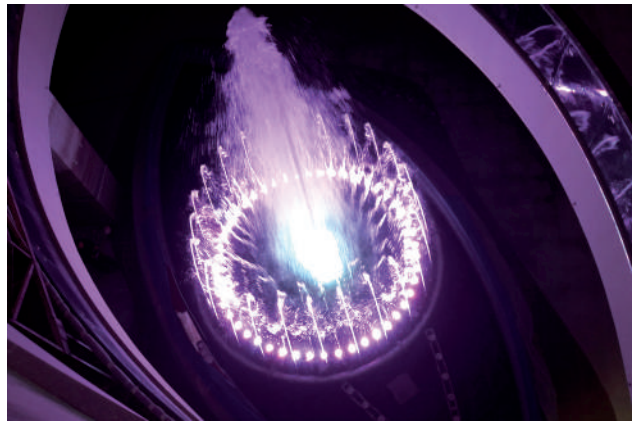

Slavyansky Shopping Mall – Moscow, Russia



Baku Geyser (140 m) – Baku, Azerbaijan



Yeni Hayat Mall – Baku, Azerbaijan



Madrid Rio Fountains – Madrid, Spain



Central Square – Dimitrovgrad, Bulgaria



Sant Adria de Besos Funsquare Barcelona, Spain



Sant Julià de Ramis Funsquare Sant Julià de Ramis, Spain

Projects



Almaty Shell Fountains – Almaty, Kazakhstan



Constitution Square – Lleida, Spain



Zenia Boulevard – Orihuela, Spain



Puerto Venecia – Zaragoza, Spain



Funsquare in Lodz – Lodz, Poland



Style Outlets Viladecans – Barcelona, Spain



Barris Central Park – Barcelona, Spain



Rehabilitations of Classical Fountains

DISCOVER OUR _____

FOUNTAINS

_____ The heart of life



STAINLESS STEEL MAINTENANCE: FREQUENCY DEPENDS ON POOL ENVIRONMENT AND CHLORINATION

POOL ENVIROMENT	CHLORINATION	MAINTENANCE FREQUENCY	CLEANING & MAINTENANCE	CLEANING FREQUENCY
Outdoor pools, inland	Chlorine	Standard	Rinse with fresh water	Weekly
			Wash with soap and water	Monthly
Outdoor pools, inland	Salt	High	Rinse with fresh water	Weekly
			Wash with soap and water	Weekly
			Remove any visible signs of rust or staining with a nylon brush	Monthly
Outdoor pools, coastal regions	Chlorine or salt	High	Rinse with fresh water	Weekly
			Wash with soap and water	Weekly
			Remove any visible signs of rust or staining with a nylon brush	Monthly
Indoor pools, all regions	Chlorine or salt	High	Rinse with fresh water	Weekly
			Wash with soap and water	Weekly
				Monthly

AstralPool' tips for lengthening the lifespan of our pools' stainless steel components

Keep the pool water in the following ranges of values:

Water pH between: 7.2-7.6

Alkalinity between: 100-175 ppm

Disinfection using Cl: 0.5-2 gr/m³

Disinfection using bromine between: 2-5 g/m³

Do not use salt-based disinfection system if the concentration of NaCl is > 6000ppm.

Water hardness control: 150-250 ppm.

Start with a weekly manual clean until the right frequency is found that matches a pool's requirements.

Keep gaps, joints and the water line clean and free of particles.

In facilities with starting blocks, pay special attention to the underside to prevent rusting from accumulated condensation.



FOR FURTHER INFORMATION
www.astralpool.com

FLUIDRA S.A.
www.fluidra.com



FLUIDRA

Avda. Alcalde Barnils 69 | 08174 Sant Cugat del Vallés (Barcelona) | Spain

Code: **75351**

© Adobe Stock

FUJIDRA POOL & SPA GENERAL CATALOGUE 2022